

ALPHACAN
ARKEMA GROUP



PANNELLI PER PORTE E PORTONCINI D'INGRESSO





I 4 plus indispensabili della porta d'ingresso

1°) Isolamento Termico:

il risparmio energetico è già di per sé una reale fonte di energia, accessibile a tutti. Migliorare la prestazione termica della nostra casa con sistemi affidabili riduce l'utilizzo dei dispositivi di riscaldamento e raffreddamento con notevoli vantaggi per le tasche e la salute.

2°) Isolamento Acustico:

suoni e rumori di elevata intensità interferiscono con le funzioni naturali degli ambienti domestici come il riposo e la tranquillità. Con Aluform, rumori molesti e la vicinanza di fabbriche, aeroporti, cantieri, strade, non rappresenteranno più motivo di stress.

3°) Sicurezza:

la sicurezza totale è un concetto difficilmente raggiungibile, ma l'applicazione di appropriati sistemi per dissuadere i malintenzionati ad introdursi nella tua abitazione, riducono di molto il verificarsi di eventi indesiderati, che si traducono sempre in una migliore qualità della vita.

4°) Assenza di manutenzione:

per rendere inattaccabili dal tempo e dagli agenti atmosferici le nostre porte, utilizziamo alluminio di prima qualità e lo sottoponiamo a cicli di trattamento all'avanguardia.



1 - ISOLAMENTO TERMICO

Il nucleo del pannello composto da schiume poliuretaniche in classe B1 (PIRALL), offre prestazioni particolarmente performanti in termini di isolamento termico, con valori inferiori a 1.0 W/Mq K.

2 - ISOLAMENTO ACUSTICO

Lastre in tecnopolimero ad alta densità, interposte nel cuore del pannello, sono in grado di abbattere suoni e rumori di elevata intensità.

3 - ANTIEFFRAZIONE

una lastra in metallo duro (ERGAL) intercalata nel centro rappresenta un valido dissuasivo per malintenzionati che volessero aprirsi un varco nella porta.

4 - NESSUNA MANUTENZIONE

A - Solo il nostro sistema prevede ben 3 strati di trattamento sulle lastre in Lega di alluminio UNI 5005
 B - Fosfocromatazione a 5 stadi;
 C - Protezione al titanio
 D - Verniciatura a polveri poliesteri spessore 0.08 o rivestimento con pellicole acriliche.

Tutti i prodotti Royal Pat sono garantiti 10 anni, (*) ma sono fatti per durare una vita. Un'ulteriore prova della convenienza e dell'eccellente qualità 100% Made in Italy.

(*) Leggi su www.royalpat.it le condizioni di garanzia.





(*) Sezioni comuni per pannelli linea **STYLE** e linea **CLASSIC**

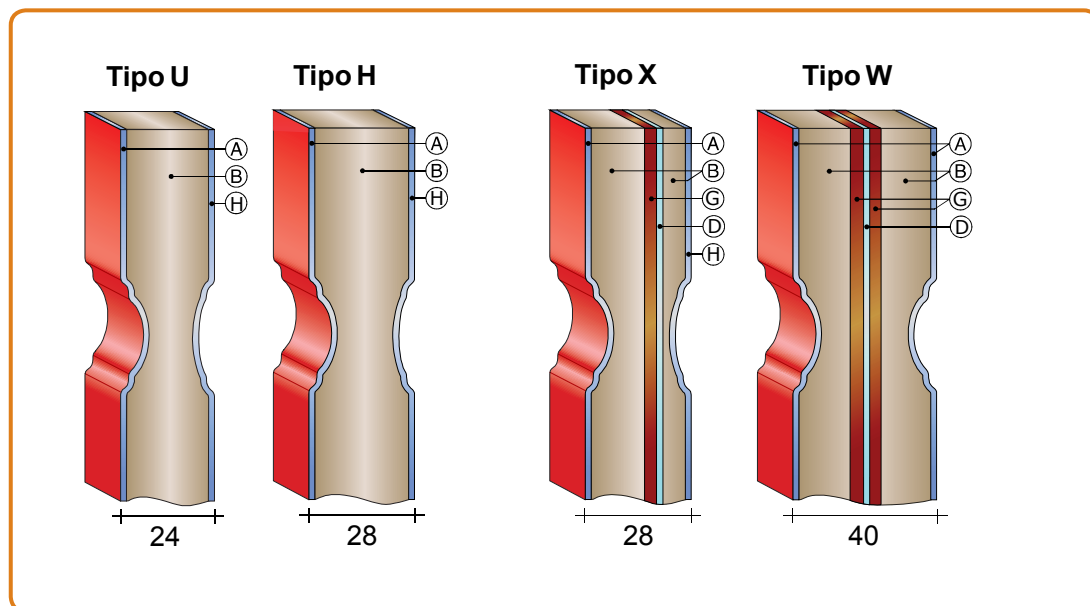

(*) Sezioni per pannelli linea **PARTNER**

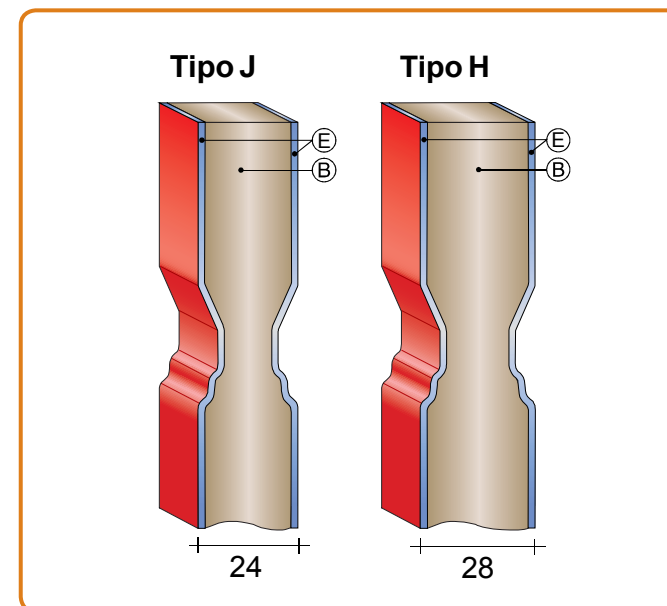

DIMENSIONI DEI PANNELLI STRUTTURALI

Standard:

anta principale 90x215 - anta laterale 45x215

Maggiorate:

anta principale 110x230 - anta laterale 55x230

- Ⓐ Alluminio bugnato profondità 13 mm
- Ⓑ Isolamento in PIRALL
- Ⓓ Lastra antieffrazione in ERGAL
- Ⓔ Alluminio bugnato profondità 10 mm
- Ⓒ Guaina elastica Acoustic Stop
- Ⓗ Alluminio bugnato profondità 5 mm

Tipo:	U	H	X	W	J
Peso mq:	10	11	19	26	10
Trasmitt. W/Mq K	1.4	1.2	1.4	1.0	1.4

(*) Le bugne della linea CLASSIC hanno un design diverso da quelle della linea Partner. Non sono pertanto abbinabili fra loro.



Caratteristiche e varianti vetro Linea CLASSIC

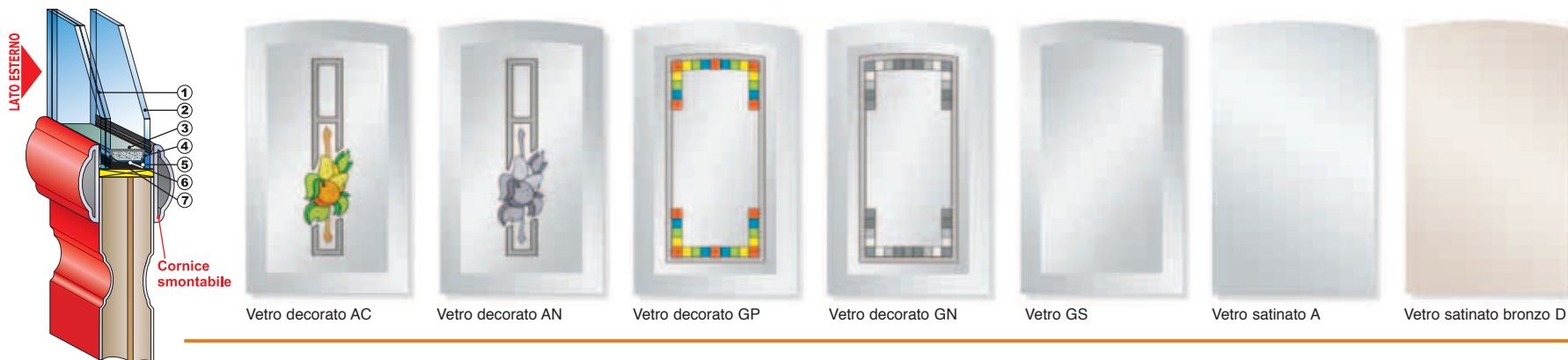

Le sezioni dei pannelli qui riportate sono una rappresentazione indicativa. Tutte le tipologie di sezioni disponibili nella pagina precedente sono realizzabili con la variante a vetri.

CARATTERISTICHE DEI VETRI

- 1 - Vetro Stratificato
- 2 - Vetro Temprato
- 3 - Silicone strutturato con dessiccanti integrati
- 4 - Prima sigillatura in butile
- 5 - Seconda sigillatura in polisolfuro DSE/DSA
- 6 - Barriera vapore
- 7 - Adesivo acrilico

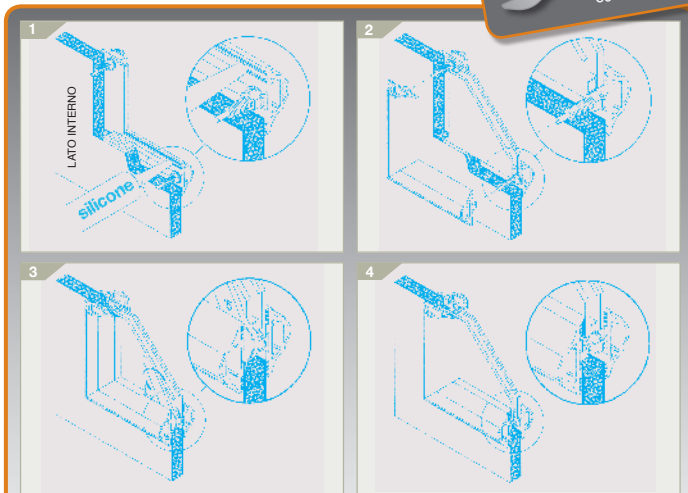

I pannelli della linea Style e Classic, hanno le cornici del vetro smontabili per sostituire o inserire vetri personalizzati

Caratteristiche e varianti vetro Linea STYLE



Caratteristiche e varianti vetro Linea PARTNER

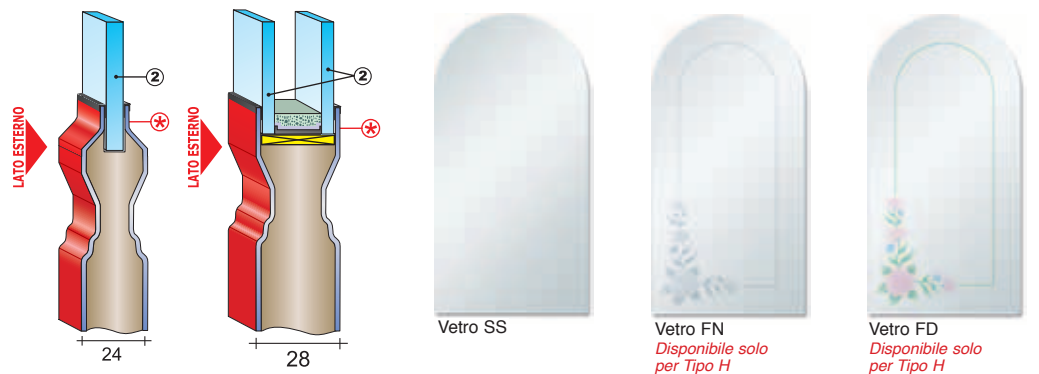

* Cornice fissa che non permette di sostituire o inserire vetri



Tipo B

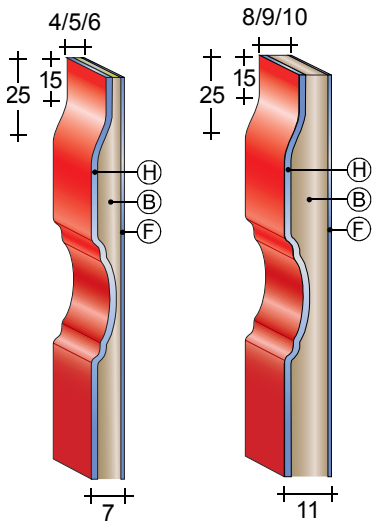

DIMENSIONI DEI PANNELLI DI RIVESTIMENTO

Standard: anta principale 110x230 - anta laterale 55x230

Ridotte: anta principale 95x215 - anta laterale 45x215

In assenza di diverse indicazioni, verrà fornito il pannello di dimensioni standard con spessore 7 mm.

- (B) Isolamento in PIRALL
- (H) Alluminio bugnato profondità 5 mm
- (F) Contro bilanciatura in alluminio

Soluzioni di vetratura

Pannelli linea CLASSIC

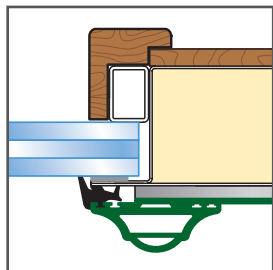

E/1
Cornice pannelli linea Classic per vetro a filo esterno porta

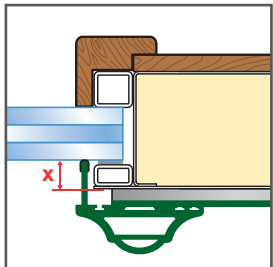

E/2
Cornice pannelli linea Classic per vetro arretrato
Per questa soluzione indicare nell'ordine la quota X (filo esterno porta-filo esterno vetro)

Pannelli linea STYLE

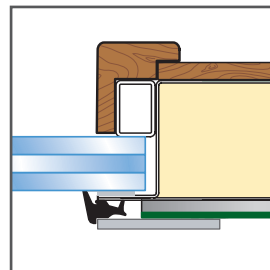

E/3
Cornice pannelli linea Style per vetro a filo esterno porta

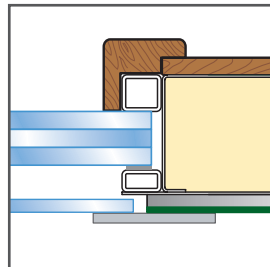

E/4
Cornice pannelli linea Style per vetro arretrato

Non sono realizzabili pannelli di rivestimento vetrati nella linea **PARTNER**

Coprifili di rifinitura

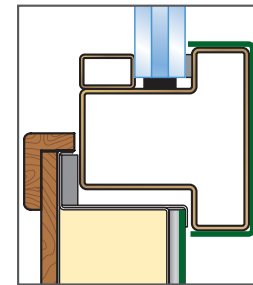

A
Profilo di rivestimento su misura per traversi e montanti

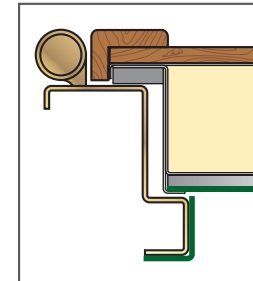

B
Profilo di rivestimento su misura per telai

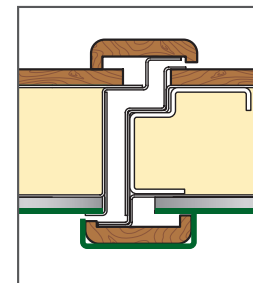

C
Profilo di rivestimento su misura per battuta porte a 2 ante

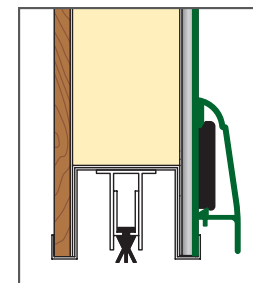

D
Gocciolatoio

COMPONENTI	
	Gocciolatoio in alluminio Assemblaggio a scatto
	Piatto in alluminio mm 1,2 A*
	Angolare in alluminio mm 1,2 (Superficie esterna in vista) B* A*
	Canalino in alluminio mm 1,2 (Superficie esterna in vista) B* A* C*
	Canalino in alluminio mm 1,2 supportato A* A* B* A = misura fissa: 6 o 11 mm
* indicare le misure in mm	



I Pannelli ALUFORM della linea Style si caratterizzano per il design elegante e raffinato. I riporti decorativi o le cornici del vetro realizzate in acciaio inox rendono la tua porta d'ingresso un moderno elemento d'arredo che esprime inequivocabilmente la tua esclusiva personalità STYLE.

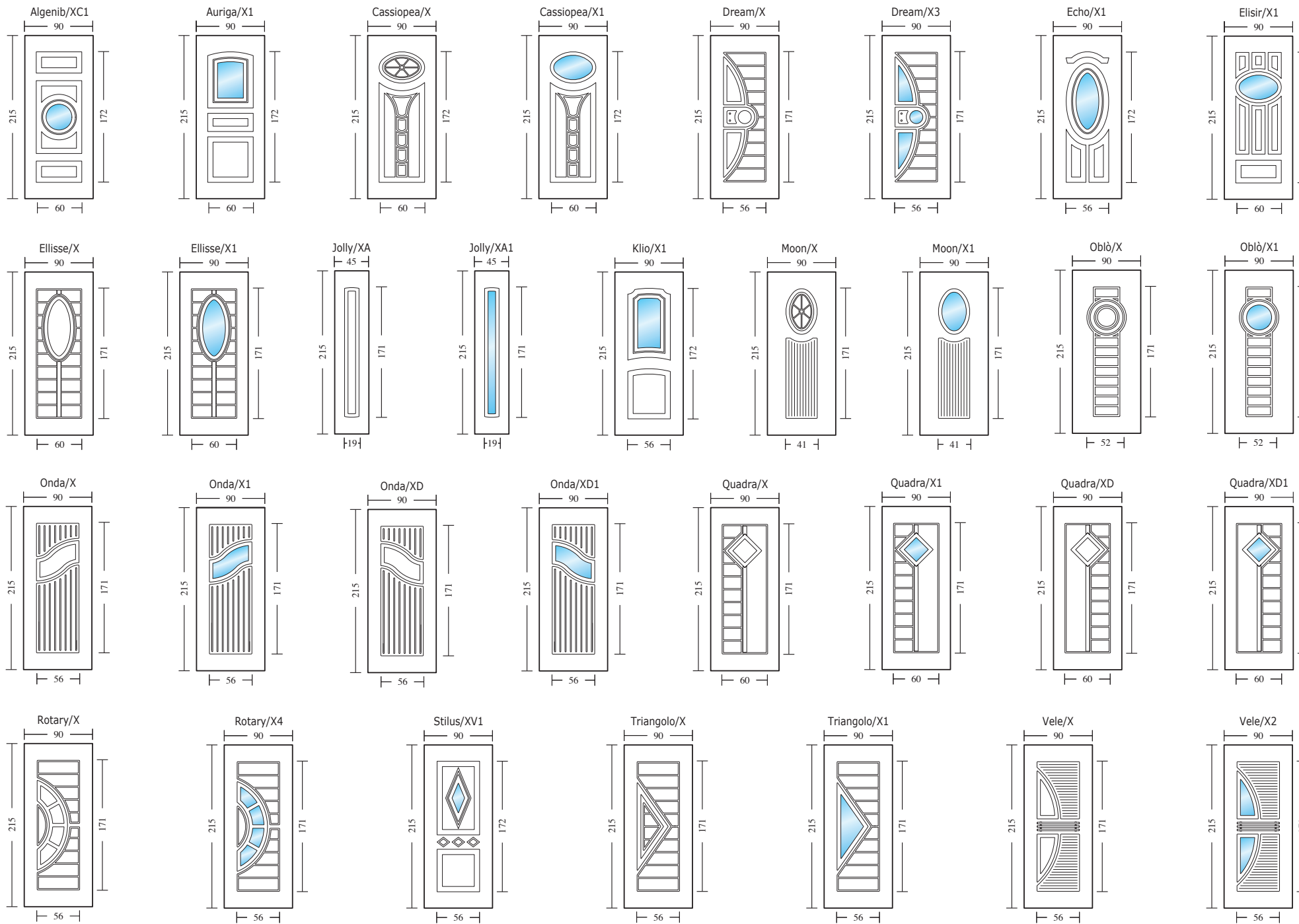



□ Mod. ALGENIB / XC1



■ Mod. AURIGA / X1



■ Mod. CASSIOPEA / X



■ Mod. CASSIOPEA / X1



■ Mod. DREAM / X



■ Mod. DREAM / X3



■ Mod. ECHO / X1



■ Mod. ELISIR / X1



■ Mod. ELLISSE / X

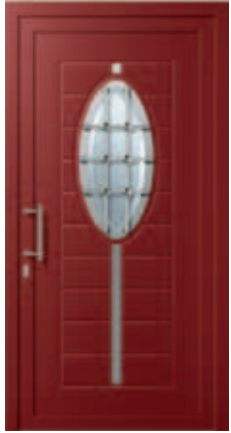

■ Mod. ELLISSE / X1



■ Mod. KLIO / X1



■ Mod. MOON / X



■ Mod. MOON / X1



■ Mod. OBLO / X



■ Mod. OBLO / X1



■ Mod. ONDA / XD



■ Mod. ONDA / XD1



■ Mod. QUADRA / XD



■ Mod. QUADRA / XD1



■ Mod. ROTARY / X



■ Mod. ROTARY / X4



■ Mod. STILUS / XV1



■ Mod. TRIANGOLO / X



■ Mod. TRIANGOLO / X1



■ Mod. VELE / X



■ Mod. VELE / X2

■ Tutti i modelli contrassegnati con il quadratino rosso sono brevettati.





Inedite linee classiche per una scelta legata alla tradizione delle forme, nel rispetto della nostra storia e dello stile architettonico che ci circonda, senza rinunciare alle attuali esigenze di sicurezza, isolamento ed assenza di manutenzione.

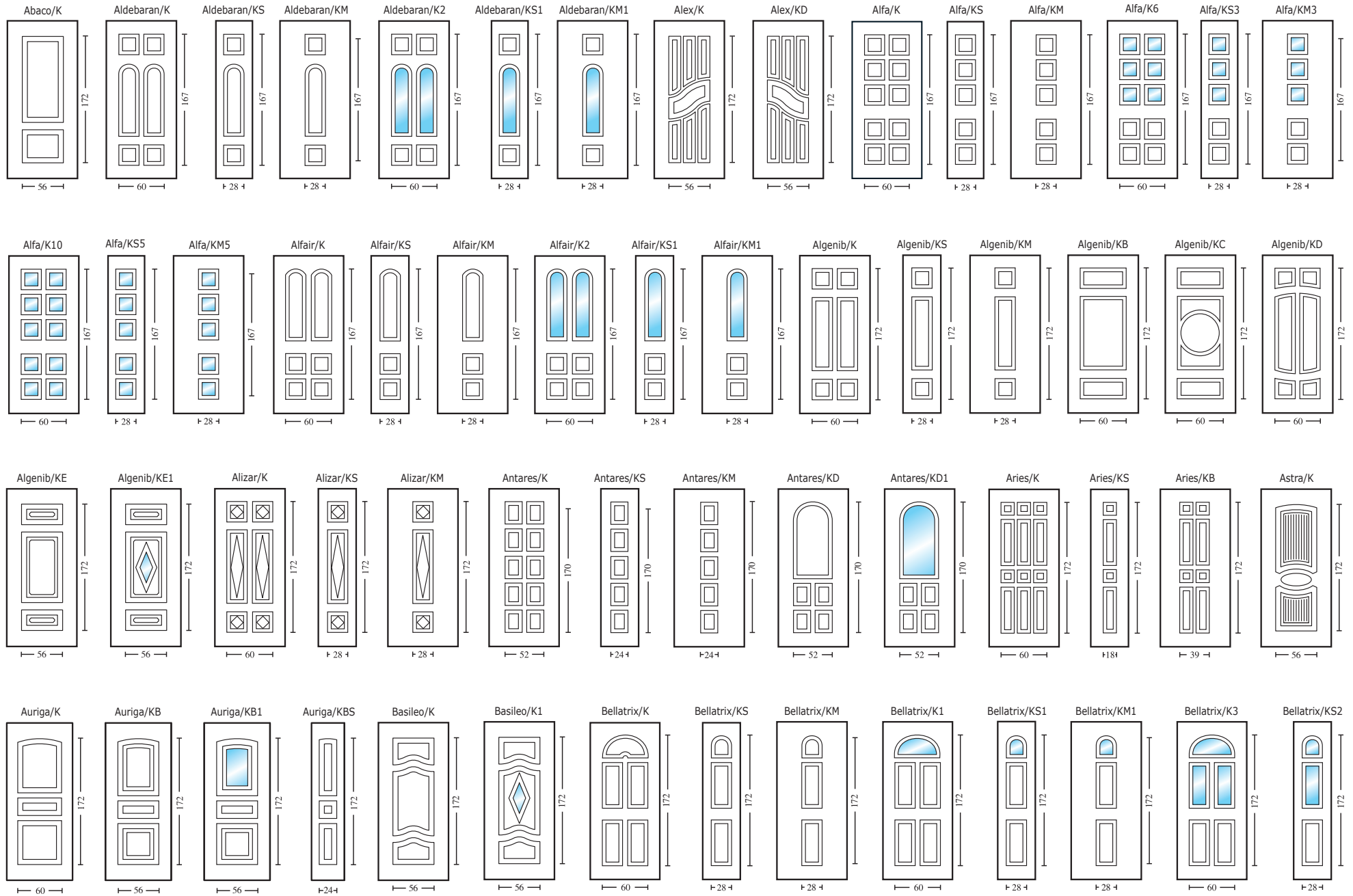

LINEA CLASSIC

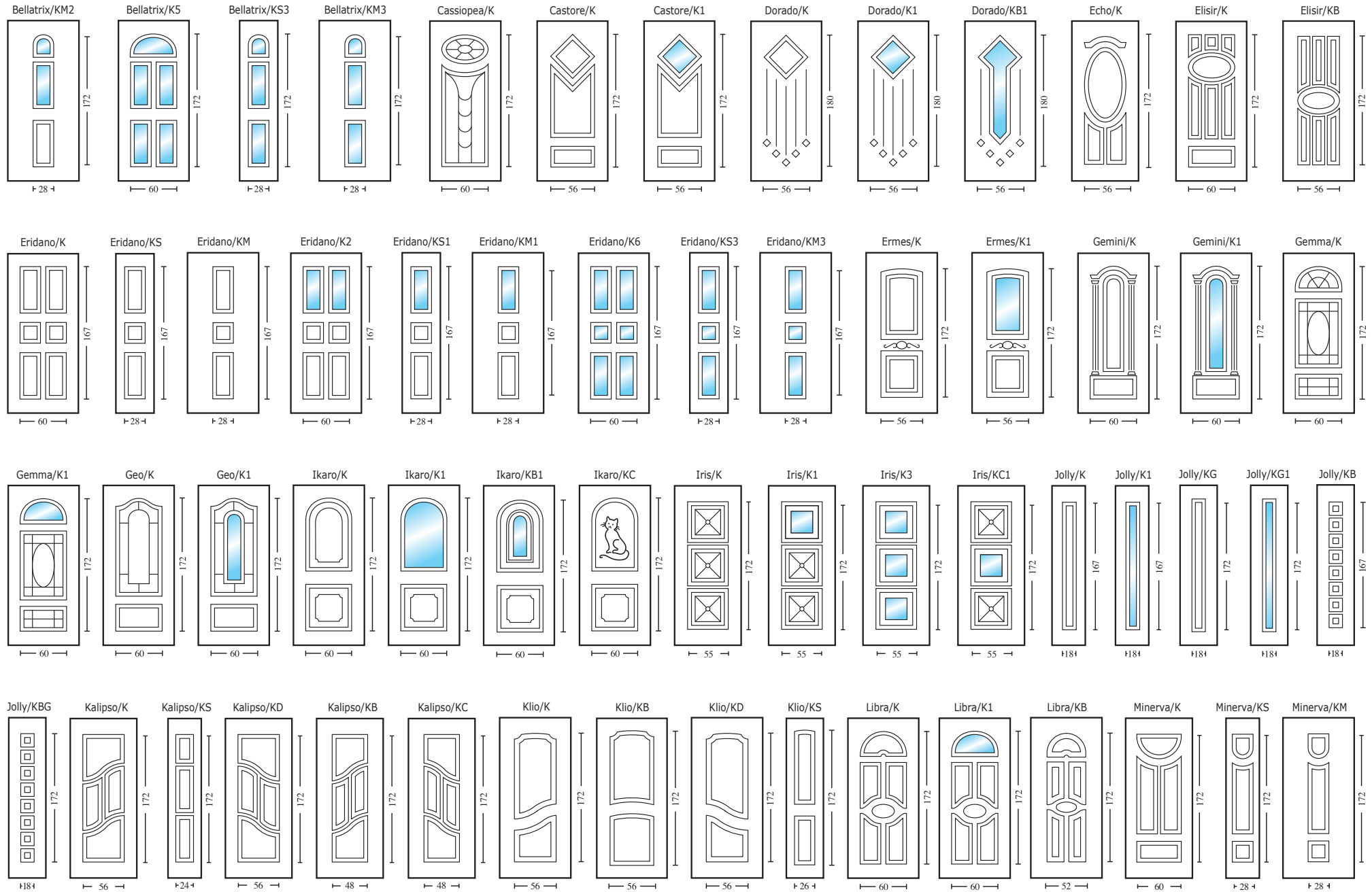

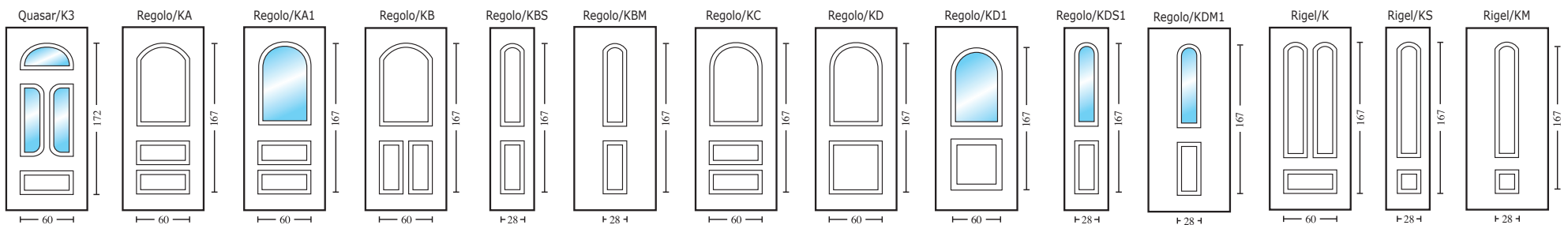
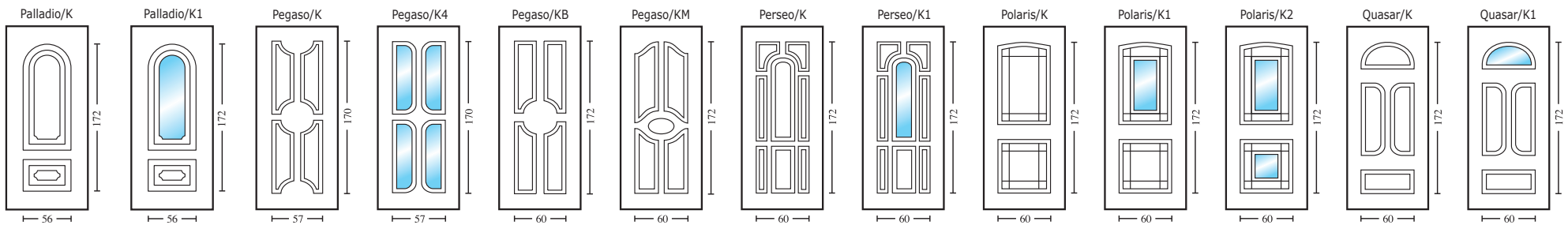
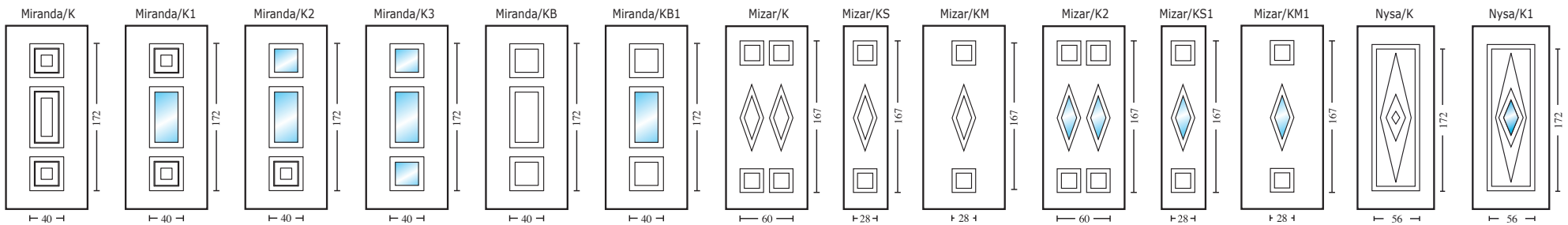
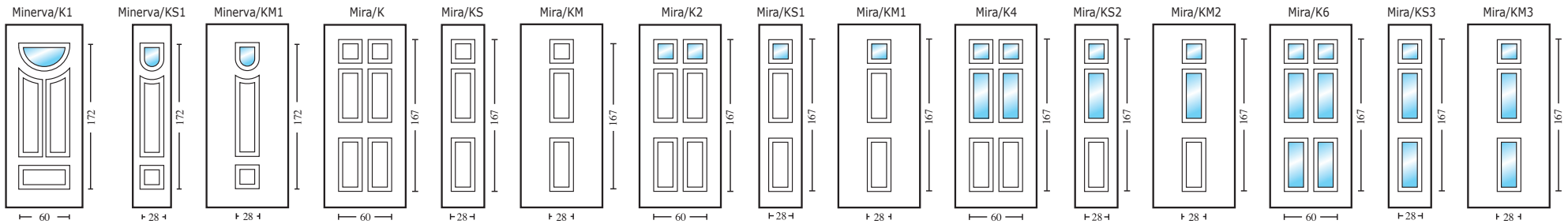

LINEA CLASSIC

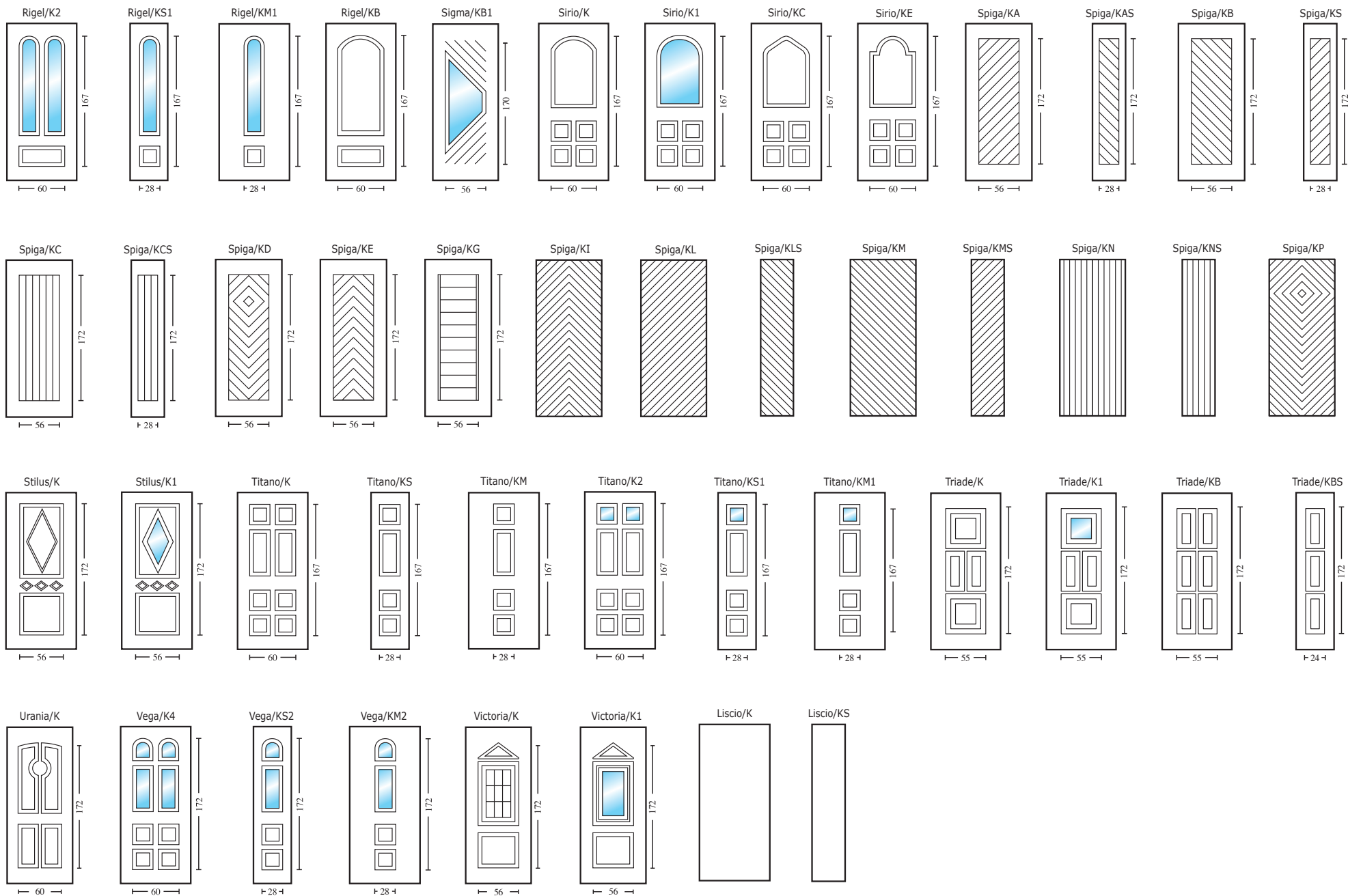



Mod. ABACO / K



Mod. ALDEBARAN / K



Mod. ALDEBARAN / K2



Mod. ALEX / K



Mod. ALFA / K



Mod. ALFA / K6



Mod. ALFA / K10



Mod. ALFAIR / K



Mod. ALFAIR / K2



Mod. ALGENIB / K



Mod. ALGENIB / KB



Mod. ALGENIB / KC



Mod. ALGENIB / KD



Mod. ALGENIB / KE



Mod. ALGENIB / KE1

Tutti i modelli contrassegnati con il quadratino rosso sono brevettati.

LINEA CLASSIC



□ Mod. ALIZAR / K



□ Mod. ANTARES / K



□ Mod. ANTARES / KD



□ Mod. ANTARES / KD1



□ Mod. ARIES / K



■ Mod. ASTRA / K



■ Mod. AURIGA / K



■ Mod. AURIGA / KB1



■ Mod. BASILEO / K



■ Mod. BASILEO / K1

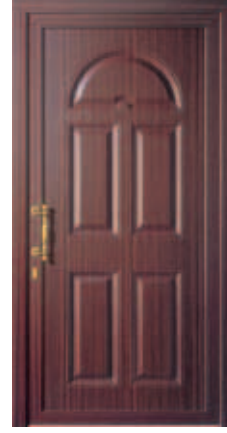

□ Mod. BELLATRIX / K



□ Mod. BELLATRIX / K1



□ Mod. BELLATRIX / K3



□ Mod. BELLATRIX / K5



■ Mod. CASSIOPEA / K



□ Mod. CASTORE / K



□ Mod. CASTORE / K1



□ Mod. DOORADO / K



☐ Mod. DOORADO / K1



■ Mod. ECHO / K



■ Mod. ELISIR / K



■ Mod. ELISIR / KB



☐ Mod. ERIDANO / K



☐ Mod. ERIDANO / K2



☐ Mod. ERIDANO / K6



■ Mod. ERMES / K



■ Mod. ERMES / K1



■ Mod. GEMINI / K



■ Mod. GEMINI / K1



■ Mod. GEMMA / K



■ Mod. GEMMA / K1



■ Mod. GEO / K

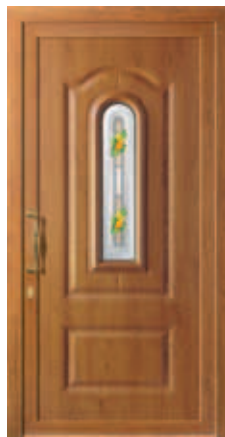

■ Mod. GEO / K1



■ Mod. IKARO / K



■ Mod. IKARO / K1



■ Mod. IKARO / KB1

■ Tutti i modelli contrassegnati con il quadratino rosso sono brevettati.

LINEA CLASSIC



■ Mod. IKAFO / KC



■ Mod. IRIS / K



■ Mod. IRIS / K1



■ Mod. IRIS / K3



■ Mod. IRIS / KC1



■ Mod. KALIPSO / KD



■ Mod. KLIO / KB



■ Mod. KLIO / KD



■ Mod. LIBRA / K



■ Mod. LIBRA / K1



■ Mod. MINERVA / K



■ Mod. MINERVA / K1



□ Mod. MIRA / K



□ Mod. MIRA / K2



□ Mod. MIRA / K4



□ Mod. MIRA / K6



□ Mod. MIRANDA / K



□ Mod. MIRANDA / K1



Mod. MIRANDA / K2



Mod. MIRANDA / K3



Mod. MIRANDA / KB



Mod. MIRANDA / KB1



Mod. MIZAR / K



Mod. MIZAR / K2



Mod. NYSA / K



Mod. NYSA / K1



Mod. PALLADIO / K

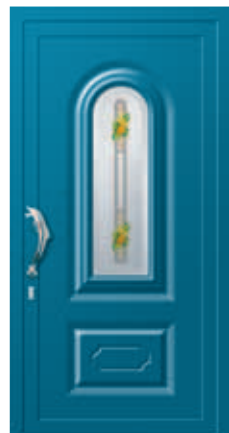

Mod. PALLADIO / K1



Mod. PEGASO / K



Mod. PEGASO / K4



Mod. PEGASO / KB



Mod. PEGASO / KM



Mod. PERSEO / K



Mod. PERSEO / K1



Mod. POLARIS / K



Mod. POLARIS / K1

Tutti i modelli contrassegnati con il quadratino rosso sono brevettati.

LINEA CLASSIC



Mod. POLARIS / K2



Mod. QUASAR / K



Mod. QUASAR / K1



Mod. QUASAR / K3



Mod. REGOLO / K



Mod. REGOLO / KA1



Mod. REGOLO / KB



Mod. REGOLO / KC



Mod. REGOLO / KD



Mod. REGOLO / KD1



Mod. RIGEL / K



Mod. RIGEL / K2



Mod. RIGEL / KB



Mod. SIGMA / KB1



Mod. SIRIO / K



Mod. SIRIO / K1



Mod. SIRIO / KC



Mod. SIRIO / KE



Mod. SPIGA / KD



Mod. SPIGA / KE



Mod. SPIGA / KG

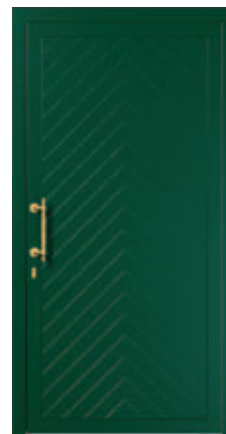

Mod. SPIGA / KI



Mod. SPIGA / KM



Mod. STILUS / K



Mod. STILUS / K1



Mod. TITANO / K



Mod. TITANO / K2



Mod. TRIADE / K



Mod. TRIADE / K1



Mod. TRIADE / KB



Mod. URANIA / K



Mod. VEGA / K4



Mod. VICTORIA / K



Mod. VICTORIA / K1



Mod. LISCIO / K

Tutti i modelli contrassegnati con il quadratino rosso sono brevettati.



Partner è la linea di pannelli che rappresenta una sintesi di funzionalità ed estetica. Abbiamo apportato in questa linea tutta la nostra esperienza per offrire un prodotto dal prezzo contenuto senza rinunciare alla qualità ed alla versatilità come nella tradizione dei prodotti Aluform.

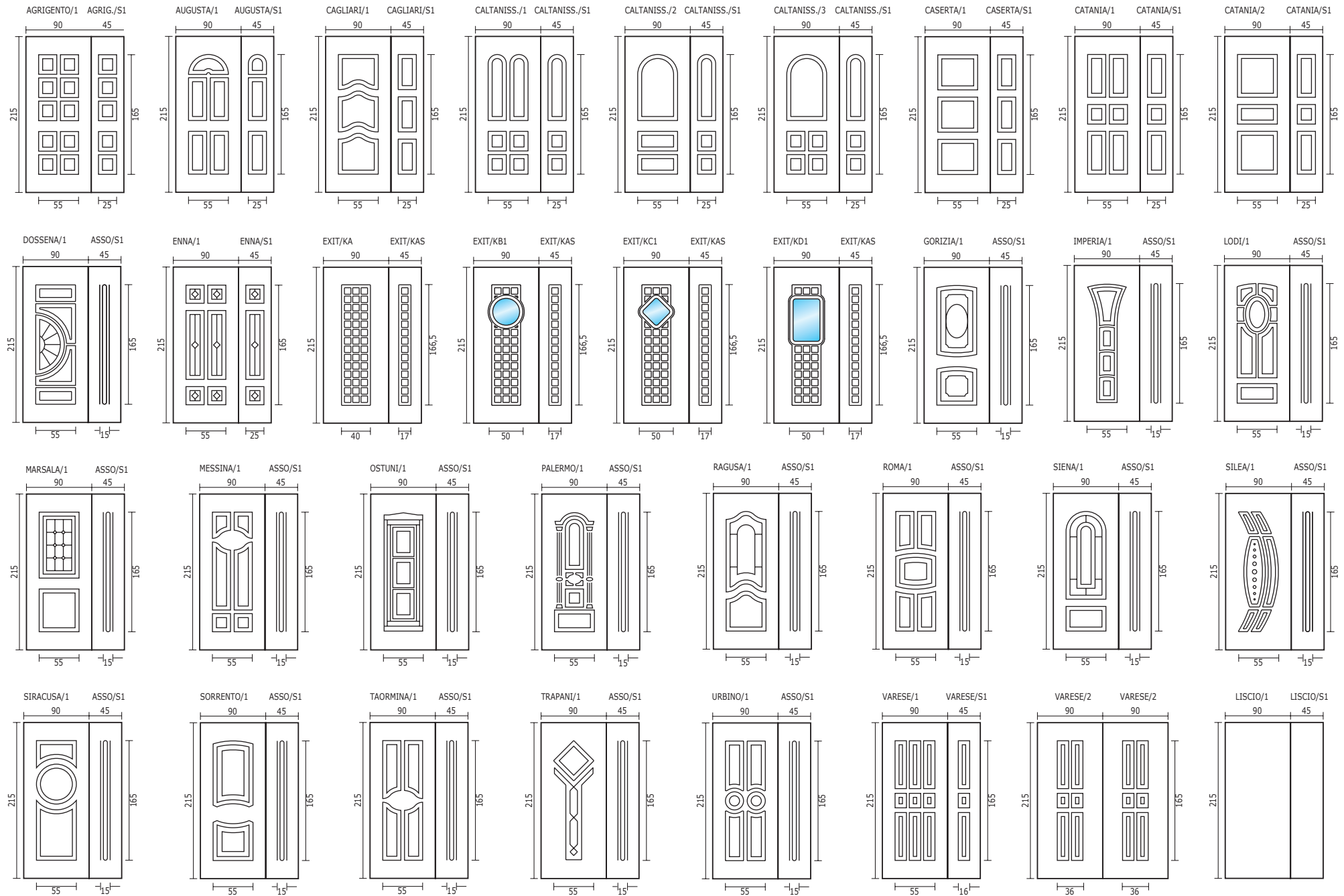

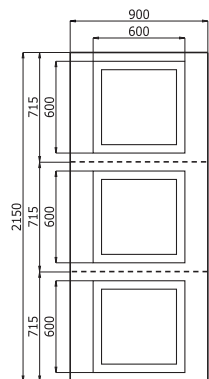

Multi/1

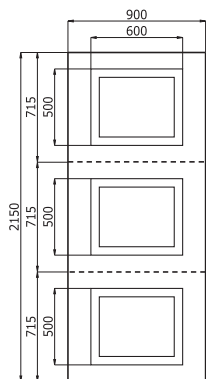

Multi/2

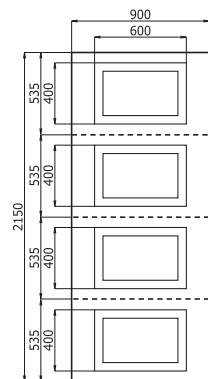

Multi/3

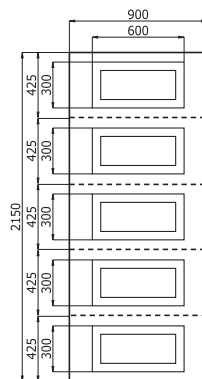

Multi/4

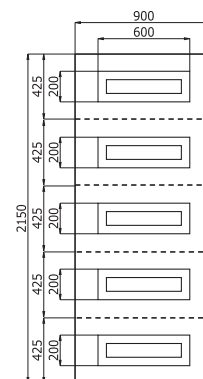

Multi/5

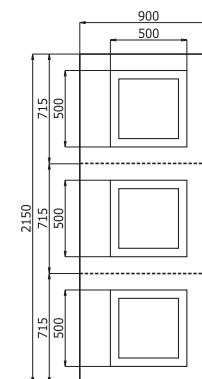

Multi/6

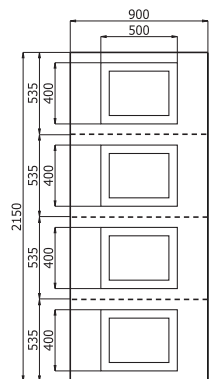

Multi/7

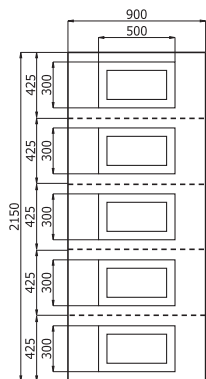

Multi/8

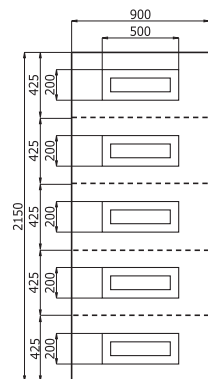

Multi/9

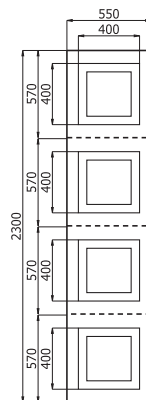

Multi/10

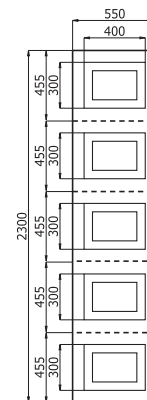

Multi/11

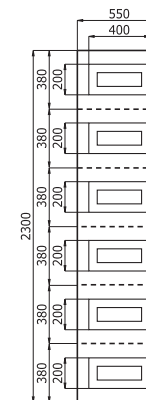

Multi/12

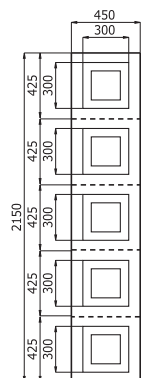

Multi/13

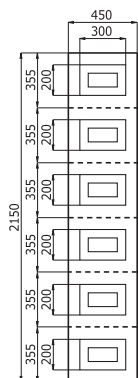

Multi/14

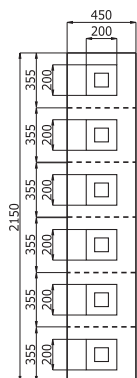

Multi/15

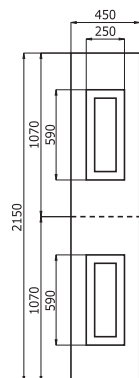

Multi/16

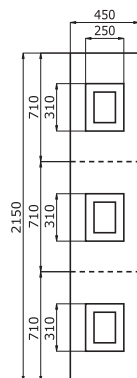

Multi/17

- I pannelli multiuso vengono forniti nel formato intero come da disegno.
- Nei colori legno e Renolit, le venature sono nel senso verticale del pannello.

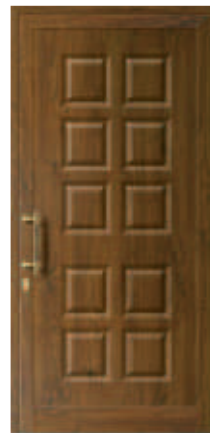
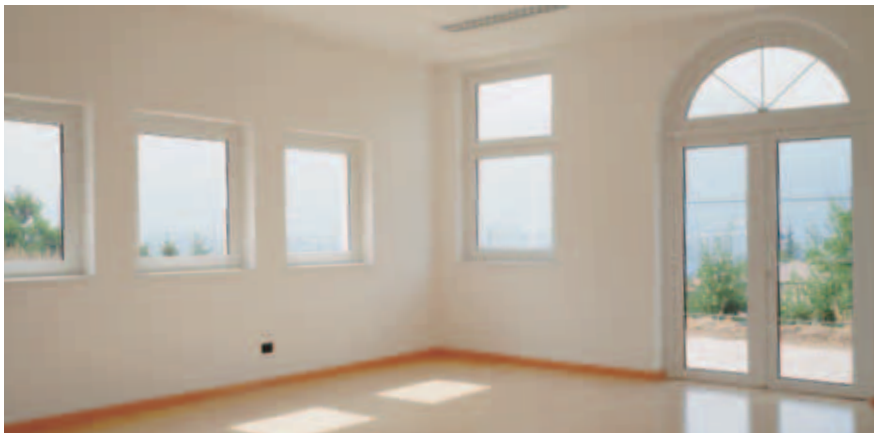

Mod. AGRIGENTO / 1



Mod. AUGUSTA / 1



Mod. AUGUSTA / V1



Mod. CAGLIARI / 1



Mod. CAGLIARI / V1



Mod. CALTANISSETTA / 1

Mod. CALTANISSETTA / SV1 (*)



Mod. CALTANISSETTA / V1



Mod. CALTANISSETTA / 2



Mod. CALTANISSETTA / V2



Mod. CALTANISSETTA / 3



Mod. CALTANISSETTA / V3



Mod. CASERTA / 1



Mod. CATANIA / 1



Mod. CATANIA / 2



■ Mod. DOSSENA / 1



■ Mod. ENNA / 1



■ Mod. EXIT / KA



■ Mod. EXIT / KB1



■ Mod. EXIT / KC1



■ Mod. EXIT / KD1



■ Mod. GORIZIA / 1



■ Mod. GORIZIA / V1



■ Mod. IMPERIA / 1



■ Mod. IMPERIA / V1



■ Mod. LODI / 1



■ Mod. LODI / V1



■ Mod. MARSALA / 1



■ Mod. MESSINA / 1



■ Mod. OSTUNI / 1



■ Mod. OSTUNI / V1



■ Mod. PALERMO / 1



■ Mod. PALERMO / V1



■ Mod. RAGUSA / 1



■ Mod. RAGUSA / V1



■ Mod. ROMA / 1



■ Mod. SIENA / 1



■ Mod. SIENA / V1



■ Mod. SILEA / 1



■ Mod. SIRACUSA / 1



■ Mod. SIRACUSA / V1



■ Mod. SORRENTO / 1



■ Mod. SORRENTO / V1



■ Mod. TAORMINA / 1



■ Mod. TRAPANI / 1



■ Mod. TRAPANI / V1



■ Mod. URBINO / 1



□ Mod. VARESE / 1



□ Mod. VARESE / 2



□ Mod. LISCIO / 1

■ Tutti i modelli contrassegnati con il quadratino rosso sono brevettati.

Ottone PVD



A 409



A 470



A 414



A 420



A 416

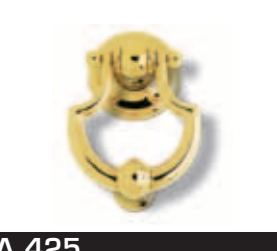

A 425



A 417



A 440



A 460



A 430

Ottone classico



A 309



A 370



A 314



A 320



A 316



A 325



A 317



A 340



A 360



A 330

Ottone satinato



A 509



A 570



A 514



A 540



A 516



A 525



A 517



A 520



A 560



A 530



A 700



A 700 P



A 723 P



A 702



A 702 P



A 732 P



A 705



A 705 P



A 712 P



A 722 P



Particolari maniglie



N. B.: La lettera P alla fine dell'articolo indica la lavorazione a punteggiatura della maniglia



A 680



A 681



A 691



A 682



A 683



A 685



A 689



A 686

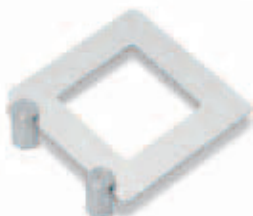

A 687



A 688

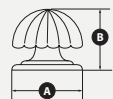
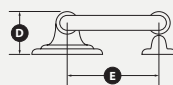
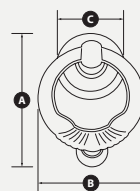
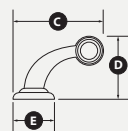
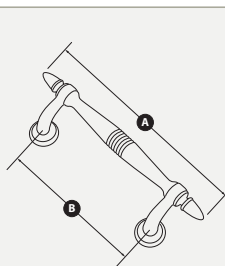

SERIE A 300 - A 400 - A 500						fissaggi inclusi nella confezione della maniglia
articoli	misure (mm)					
	A	B	C	D	E	
A 309 - A 409 - A 509	320	280	80	88	45	R - P
A 314 - A 414 - A 514	336	230	90	68	44	R - P
A 316 - A 416 - A 516	307	230	90	68	44	R - P
A 317 - A 417 - A 517	309	230	90	68	44	R - P
A 340 - A 440 - A 520	165	135	79	58	110	R
A 325 - A 425 - A 525	163	110	79	63	107	R
A 330 - A 430 - A 530	81	83	-	-	-	R
A 320 - A 420 - A 540	155	118	79	60	100	R
A 360 - A 460 - A 560	260	215	115	79	45	R - P
A 370 - A 470 - A 570	340	235	94	73	44	R - P

SERIE A 700						
	A	B	C	D	E	
A 700	610	430	120	75	32	P
A 700 P	610	430	120	75	32	P
A 702	600	425	76	75	32	P
A 702 P	600	425	76	75	32	P
A 705	700	600	105	83	32	P
A 705 P	700	600	105	83	32	P
A 712 P	600	400	80	65	32	P
A 722 P	600	425	58	65	38	P
A 723 P	600	562	-	62	38	P
A 732 P	800	500	80	80	32	P

SERIE A 600						
	A	B	C	D	E	
A 680	420	250	157	52	32	P
A 681	394	280	176	52	32	P
A 682	372	250	212	52	32	P
A 683	300	185	174	52	32	P
A 685	200	125	194	52	32	P
A 686	200	125	217	52	32	P
A 687	200	125	217	52	32	P
A 688	200	125	217	52	32	P
A 689	200	125	194	52	32	P
A 691	420	250	117	52	32	P

FISSAGGI: serie 600 - 700

Fissaggio di serie con vite passante incluso nella confezione della maniglia

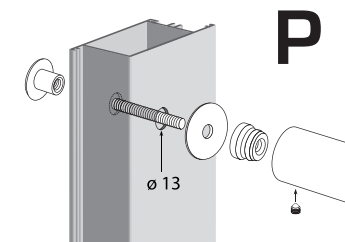

Fissaggio singolo non passante da ordinare separatamente

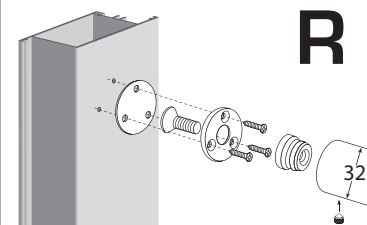

Cod. ATR732 Inox

Fissaggio singolo non passante da ordinare separatamente

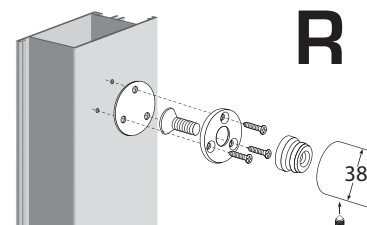

Cod. ATR 738 Inox
Solo per gli articoli: A 722 P, A 723 P



NC601 acciaio inox satinato
NC602 acciaio inox satinato
NC603 acciaio inox satinato
NC604 acciaio inox satinato
NC605 acciaio inox satinato



NC606 acciaio inox satinato
NC607 acciaio inox satinato
NC608 acciaio inox satinato
NC609 acciaio inox satinato
NC600 acciaio inox satinato



NC600A acciaio inox satinato
NC600B acciaio inox satinato
NC600C acciaio inox satinato
NC600D acciaio inox satinato



36



NC651
 Placca in plexiglas per 1 numero



NC652
 Placca in plexiglas per 2 numeri



NC653
 Placca in plexiglas per 3 numeri



NC654
 Placca in plexiglas per 4 numeri



NC661
 Placca in acciaio verniciato per 1 numero



NC662
 Placca in acciaio verniciato per 2 numeri



NC663
 Placca in acciaio verniciato per 3 numeri



NC664
 Placca in acciaio verniciato per 4 numeri

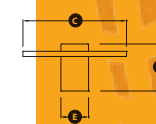
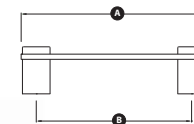

articolo	misure mm					attacco
	A	B	C	D	E	
NC651	190	155	120	54	32	Tassello da 8 mm
NC652	215	180	120	54	32	Tassello da 8 mm
NC653	265	230	130	54	32	Tassello da 8 mm
NC654	315	280	140	54	32	Tassello da 8 mm

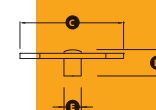
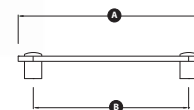

articolo	misure mm					attacco
	A	B	C	D	E	
NC661	192	155	125	29	20	Tassello da 8 mm
NC662	217	180	129	29	20	Tassello da 8 mm
NC663	270	230	147	29	20	Tassello da 8 mm
NC664	323	280	162	29	20	Tassello da 8 mm

Progetto NEWENTRY

Il nome pensilina deriva dal latino pensilis e sta ad indicare una struttura di copertura sporgente da un edificio, atta a proteggere persone o cose dal sole e dalla pioggia.

La sua storia comincia nel 64 d.C., quando Nerone diede ordine di costruire dei colonnati di fronte alle abitazioni per proteggere i romani dalle intemperie. Negli anni, la pensilina si è adeguata agli stili delle varie epoche, adottando materiali diversi: legno, ferro battuto, fusioni in ghisa, vetro, etc, in sintonia con la crescente industrializzazione, il gusto e la cultura della gente. Dalla primordiale funzione di semplice riparo, essa è diventata anche un importante elemento distintivo di arredo e decoro per l'ingresso delle nostre case.

Nel realizzare questo progetto, noi stessi ci siamo sorpresi nell'osservare le infinite occasioni in cui, durante la giornata, questo antico oggetto si rende silenziosamente e gradevolmente utile, come: cercare le chiavi, aprire la porta, citofonare, ritirare la posta, chiudere o aprire l'ombrello, appoggiare le borse della spesa, attendere l'arrivo di qualcuno, fumarsi una sigaretta, chiacchierare, telefonare, leggere e, perchè no, starsene beatamente ad osservare la gente che passa.

Con Newentry, crediamo di aver interpretato al meglio le attuali esigenze di sicurezza e zero manutenzione. Sfruttando il progresso nell'utilizzo dei materiali e dei sistemi di produzione, abbiamo realizzato un'eccellente oggetto di arredo e personalizzazione, oltre che un valido riparo da pioggia, neve e sole per ingressi, finestre, balconi e vetrine, per tutti i gusti e nel rispetto degli stili architettonici patrimonio della nostra storia.





Stile Moderno

Le filosofie progettuali dello stile contemporaneo fondono nell'aspetto estetico le funzioni d'uso e le caratteristiche costruttive, collegando questi aspetti in una logica moderna e razionale.

Nel realizzare il design di un prodotto si risolvono problemi e si migliora l'ergonomia e l'utilizzo. Studiamo la forma dell'oggetto, in relazione alla sua funzione in armonia con l'ambiente circostante. I nuovi sistemi di produzione e il progresso nell'uso dei materiali costituiscono un fondamentale potenziamento della creatività e uno sviluppo esponenziale di questo stile.

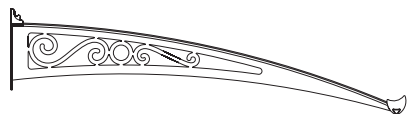

Stile Classico

Un design nostalgico ispirato a richiami e reinterpretazioni di decori semplici ma immortali, che la tecnologia moderna e le nuove tecniche di lavorazione dei materiali permettono oggi di realizzare facilmente.

Le giuste proporzioni tra le volute e lo scorrere armonico delle linee flessuose ed arricciate trovano, nella precisione assoluta dei tagli laser guidati dal computer, una nuova occasione per esaltare la bellezza di uno stile che continua a fare storia.



Stile Liberty

Lo stile Liberty o Art Nouveau, come veniva anche chiamato, ebbe inizio nel 1890. Trionfò già dai primi del 900 e si configurò come stile ad ampio raggio, influenzando l'architettura, il design d'interni, la gioielleria, i mobili e i tessuti, gli utensili, l'oggettistica e l'illuminazione.

Una delle caratteristiche più importanti dello stile Liberty sono le forme organiche che traggono ispirazione dalla natura, traducendone gli elementi strutturali in linee dinamiche e ondulate. Semplici figure prendono vita per evolversi naturalmente in forme simili a piante o fiori.



CERTIFICAZIONI:

- Carico neve: fino a 200 Kg/m²
- Spinta del vento: 100 Kg/m²
- Resistenza alla nebbia salina: 500 ore





...le linee essenziali e le forme minimaliste dello stile moderno

Colore della struttura: 9006 silver grinz
Colore del tetto: neutro statinato

Salvo diverse indicazioni la pensilina sarà fornita in questa versione



Colore della struttura: 9010 opaco,
mensole acciaio inox AISI 316 satinato a vista
Colore del tetto: trasparente

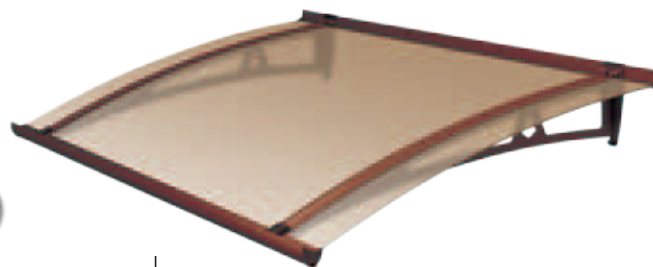

Colore della struttura: marrone corten
Colore del tetto: bronzo

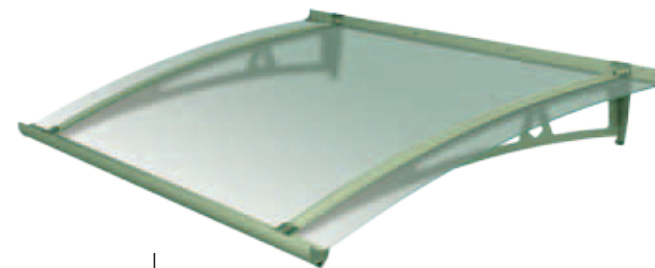

Colore della struttura: 6021 opaco
Colore del tetto: verde bottiglia

MENSOLA STANDARD

B	750	1000	1250	1500
A	165	205	240	280
C	45	65	80	90

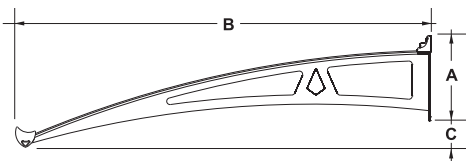

MENSOLA SOTTOBALCONE

B	750	1000	1250	1500
A	100	100	120	120
C	120	170	200	250
D	240	315	390	450

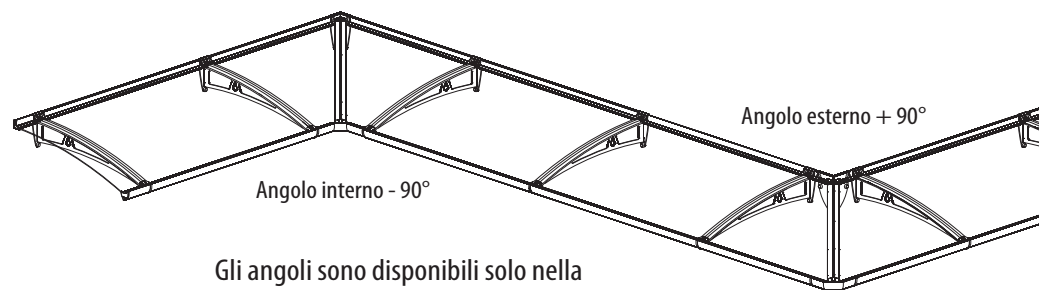
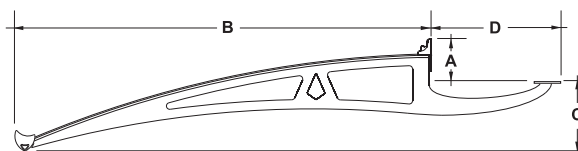

Gli angoli sono disponibili solo nella versione con mensola standard





Colore della struttura: antracite
Colore del tetto: neutro statinato

Salvo diverse indicazioni la pensilina sarà fornita in questa versione



Colore della struttura: : 9006 silver grinz
Colore del tetto: trasparente

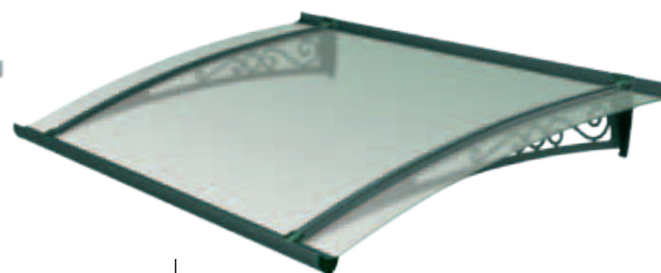

Colore della struttura: verde grinz
Colore del tetto: verde bottiglia

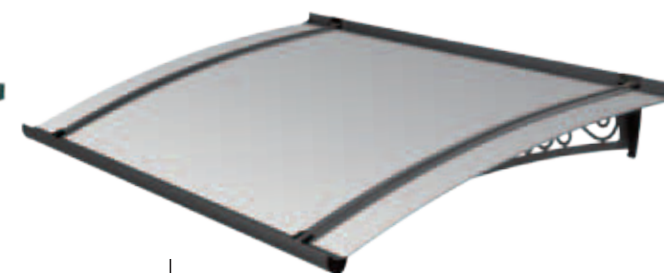

Colore della struttura: antracite
Colore del tetto: solar control

MENSOLA STANDARD

B	750	1000	1250	1500
A	165	205	240	280
C	45	65	80	90

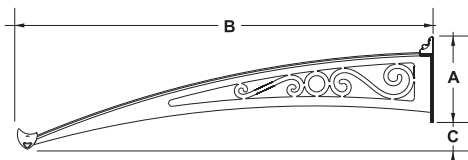

MENSOLA SOTTOBALCONE

B	750	1000	1250	1500
A	100	100	120	120
C	120	170	200	250
D	240	315	390	450

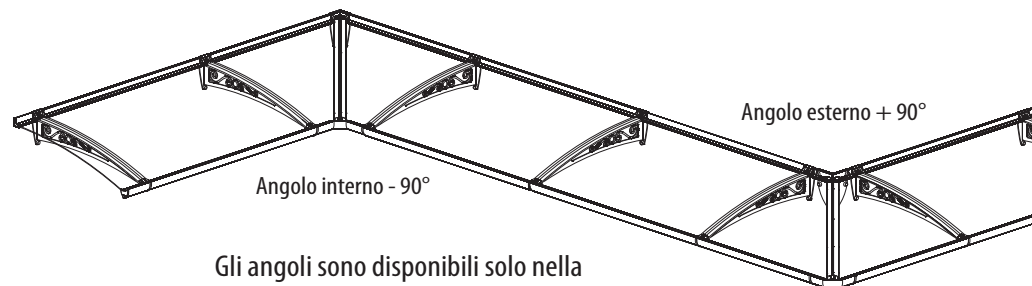
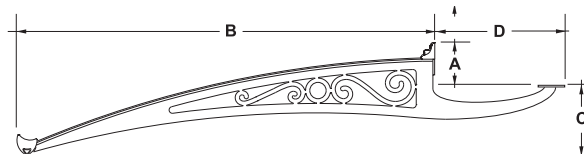

Gli angoli sono disponibili solo nella versione con mensola standard





...l'armonia delle volute e il gusto del decoro di uno stile intramontabile

Colore della struttura: antracite
Colore del tetto: neutro statinato

Salvo diverse indicazioni la pensilina sarà fornita in questa versione



Colore della struttura: 1013 opaco
Colore del tetto: trasparente



Colore della struttura: 6005 opaco
Colore del tetto: verde bottiglia



Colore della struttura: bronzo opaco
Colore del tetto: bronzo

MENSOLA STANDARD

B	700	1000	1300
A	155	175	220
C	20	70	80

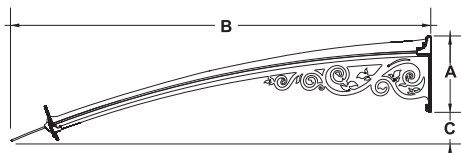

MENSOLA SOTTOBALCONE

B	700	1000	1300
A	100	100	120
C	70	140	180
D	240	300	360

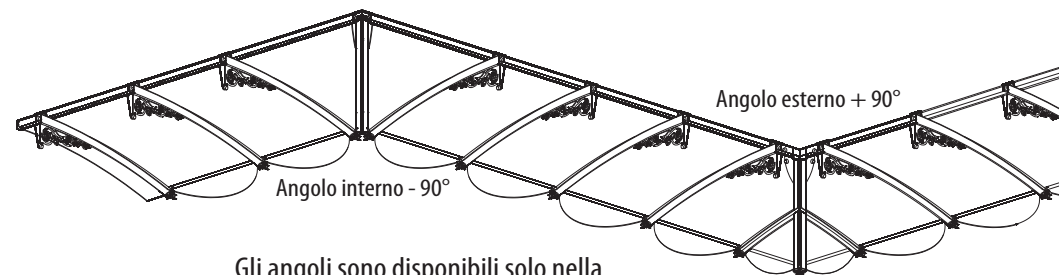
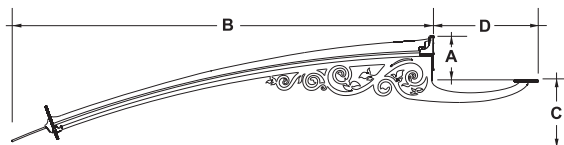

Gli angoli sono disponibili solo nella versione con mensola standard

Si installa facilmente

Newentry è fornita in kit completo di tutta la viteria e le istruzioni per il montaggio. Grazie ad un sistema di assemblaggio rapido e brevettato la pensilina si installa in modo facile e veloce.



Modulare

Newentry adotta un sistema modulare. Affiancando più moduli, l'uno dopo l'altro, si può raggiungere qualsiasi lunghezza. Inoltre, questo sistema permette di allungare, accorciare o spostare altrove la pensilina in qualsiasi momento.



Rifinita

Una grondaia ben integrata nel design raccoglie e convoglia l'acqua sugli appositi scarichi laterali. Così Newentry ha definitivamente risolto anche i fastidiosi sgocciolamenti davanti al tuo ingresso.



Robusta ed indistruttibile

Le mensole portanti della pensilina Newentry sono realizzate in acciaio inox AISI 430, il resto della struttura è costituita da estrusi in lega di alluminio 6060. Il tutto protetto da un rivestimento in polvere poliesteri cotte in forno a 200°.



Curata in ogni dettaglio

Una speciale guarnizione in gomma estrusa, nascosta nella struttura, evita eventuali infiltrazioni di acqua fra muro e pensilina.



Newentry unica come te

È predisposta per girare negli angoli e per prolungare balconi e cornicioni. E quando le misure standard non soddisfano le tue esigenze, Newentry realizza la pensilina su misura, fatta apposta per te.

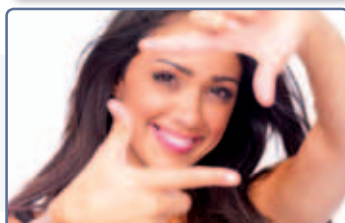

Chi vuole il meglio non deve mai accontentarsi

Oltre alla nostra selezione dei 30 colori in cartella, Newentry ti offre la possibilità di ordinare la tua pensilina nel colore che più preferisci fra le oltre 300 tonalità della scala RAL.



Newentry non ti abbandona mai

In caso di incidente, sono sempre disponibili pezzi di ricambio per effettuare qualsiasi riparazione. Con i ricambi originali Newentry, la tua pensilina tornerà perfettamente come nuova.



Non necessita di manutenzione.

Newentry è assemblata con viti in acciaio inox non in vista. Tutti gli spigoli sono smussati per facilitare l'ordinaria pulizia semplicemente con acqua e sapone.



Coscienza verde

Per la realizzazione delle pensiline Newentry abbiamo preferito materiali e cicli di verniciatura con il più basso impatto ambientale.



Testate e certificate

Le pensiline Newentry sono pronte a tutto. Per loro pioggia, neve, grandine e vento non rappresentano una minaccia. Le certificazioni di ISTDIL dimostrano l'elevata resistenza alla pressione del vento ed al carico neve fino a 200 Kg mq.



Garantita

Le pensiline Newentry sono garantite 10 anni ma sono fatte per durare una vita. Un'ulteriore prova dell'eccellente qualità tutta Made in Italy.





Applicazioni speciali

Campioni dimostrativi da esposizione



Mod. A NEW STYLE

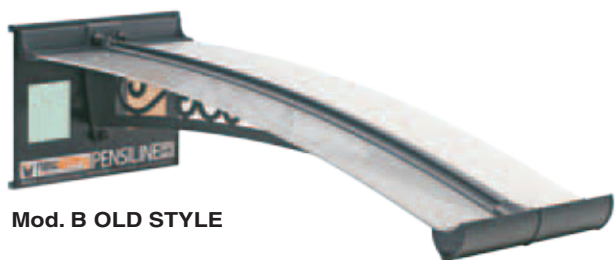

Mod. B OLD STYLE



Mod. C LIBERTY STYLE

Variazione di pendenza

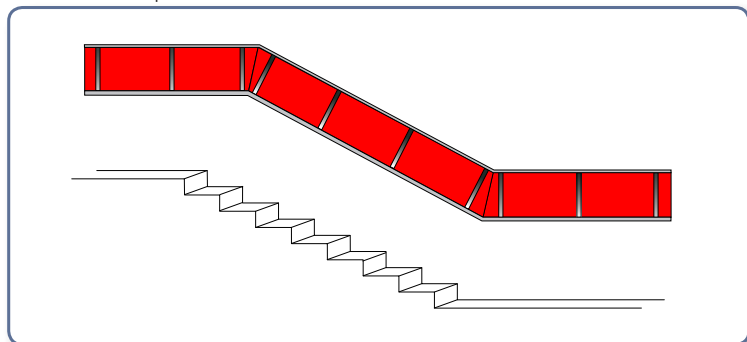

Per ogni esigenza di installazione, NEWENTRY® realizza la pensilina fatta apposta per te.

Applicazione sottobalcone

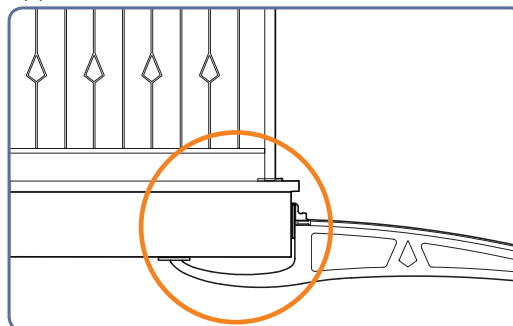

Laterale paravento e pioggia



Variazione interasse mensole

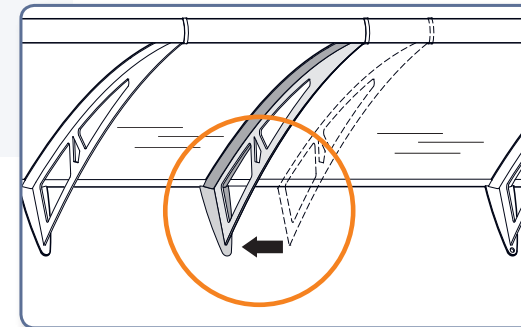

Passaggio tubi discendenti

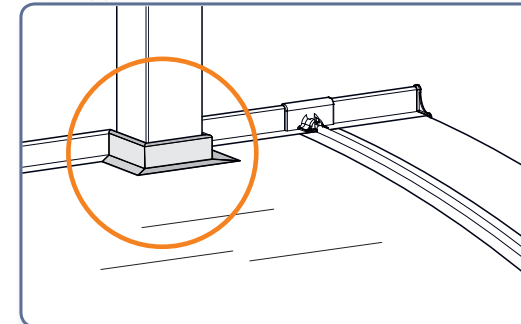

Predisposizione a tubazioni di scolo

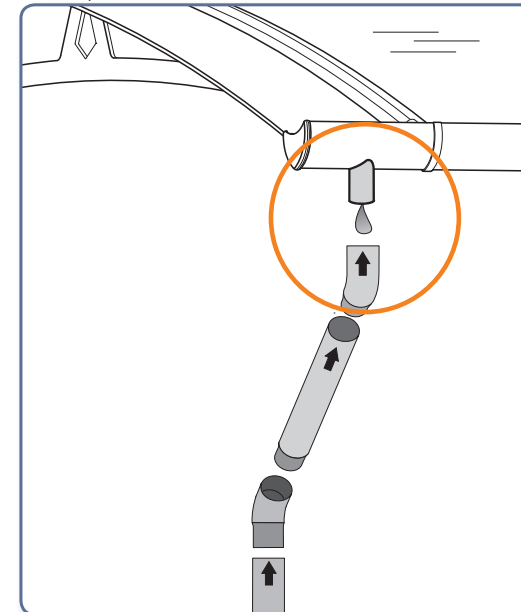

Colori della copertura

Non si rompe e non ingiallisce

La copertura delle pensiline Newentry è costituita da lastre in vetro acrilico antiurto Poly-Plex spessore 4mm. Per l'elevata resistenza ai raggi ultravioletti e l'ottimo grado di resistenza agli urti, le lastre in Poly-Plex rappresentano la migliore soluzione disponibile sul mercato per questo tipo di applicazioni.



Verde bottiglia



Bronzo

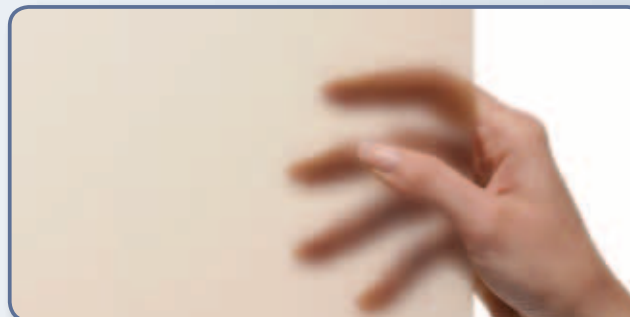

Trasparente



Solar control

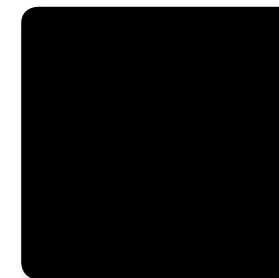
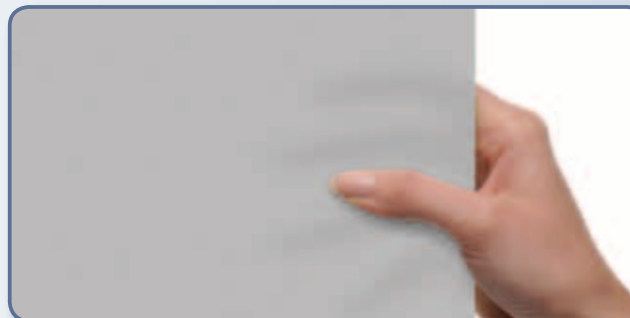

Nero 9005 opaco

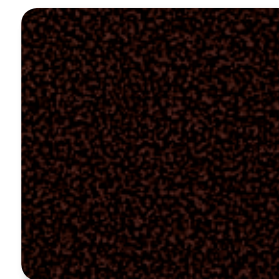

Marrone ramato grinz

- Su richiesta sono disponibili tutti i colori della scala RAL.
- Per limiti tecnologici di stampa, i colori della presente cartella sono puramente indicativi. Essi non possono pertanto rappresentare oggetto di contestazione per l'eventuale differenza con il colore del prodotto acquistato.





Colori della struttura



Grigio antracite



Grigio P 7000



Grigio 7016 opaco



Grigio 7001 opaco

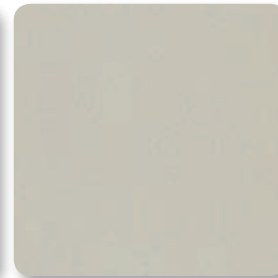

Grigio 7035 opaco



Grigio 9006 Silver Grinz



Marrone P7203 grinz



Marrone P 7200



Marrone grinz



Marrone 8017 opaco



Marrone 8011 opaco



Marrone corten



Bronzo opaco



Rosso P 7300



Rosso 3005 opaco



Rosso 3003 opaco



Verde P 7103 grinz



Verde grinz

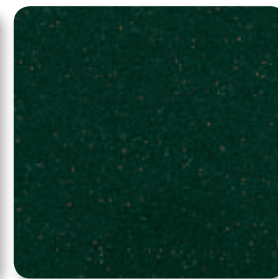

Verde P 7100



Verde 6005 opaco



Verde 6021 opaco



Blu 5010 opaco



Azzurro 5015 opaco



Giallo 1033 opaco

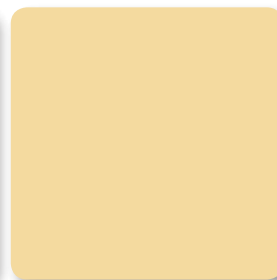

Nc004 opaco

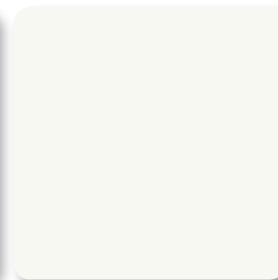

Bianco P 7503 grinz



Bianco 1013 opaco



Bianco 9010 opaco

sede legale e amministrativa:
I - 38062 Arco (TN) - Via S. Caterina, 60/C
Tel. +39 0464 587 500 - Fax 0464 512 892

ALPHACAN S.p.A.



stabilimento:
I - 38062 Arco (TN) - Via S. Sisto, 20/A
Tel. +39 0464 587 500 - Fax 0464 532 211