



ALMACENAJE Y MESAS AUXILIARES / STORAGE AND AUXILIARY TABLES

INDEX

Mesas auxiliares

Auxiliary tables

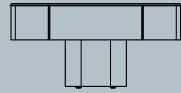

Chrysler
12-17

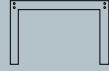

Aliante
18-23



Nina
24-27

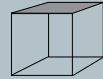

Mini Table
28-31



Té
32-35



Verónica
36-41

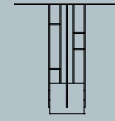

Fuste
42-45



Rufina
46-49

Almacenaje

Storage

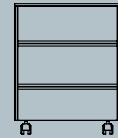

K-Bes
54-57

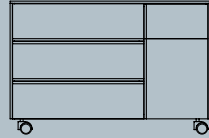

PTF
58-61

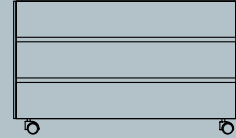

Mix Roulotte
62-65

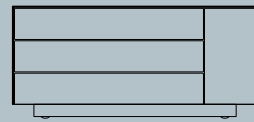

Ax
66-69

Almacenaje Horizontal

Storage Horizontal

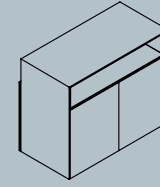

Bis-75
72-75

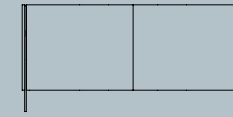

H-Mix
76-93

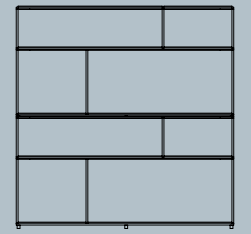

Cota
94-101

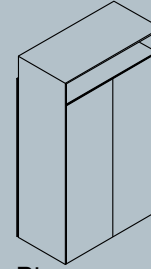

Bis
102-109

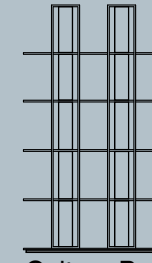

Culture Box
110-115

Oficina en casa

Home office

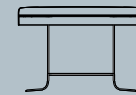

Unipers
118-121

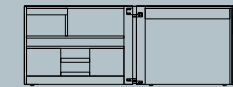

HO Cube
122-127

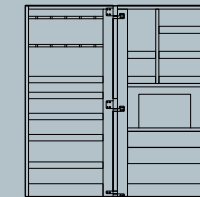

OK Cube
128-133

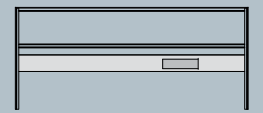

Backstage
134-141

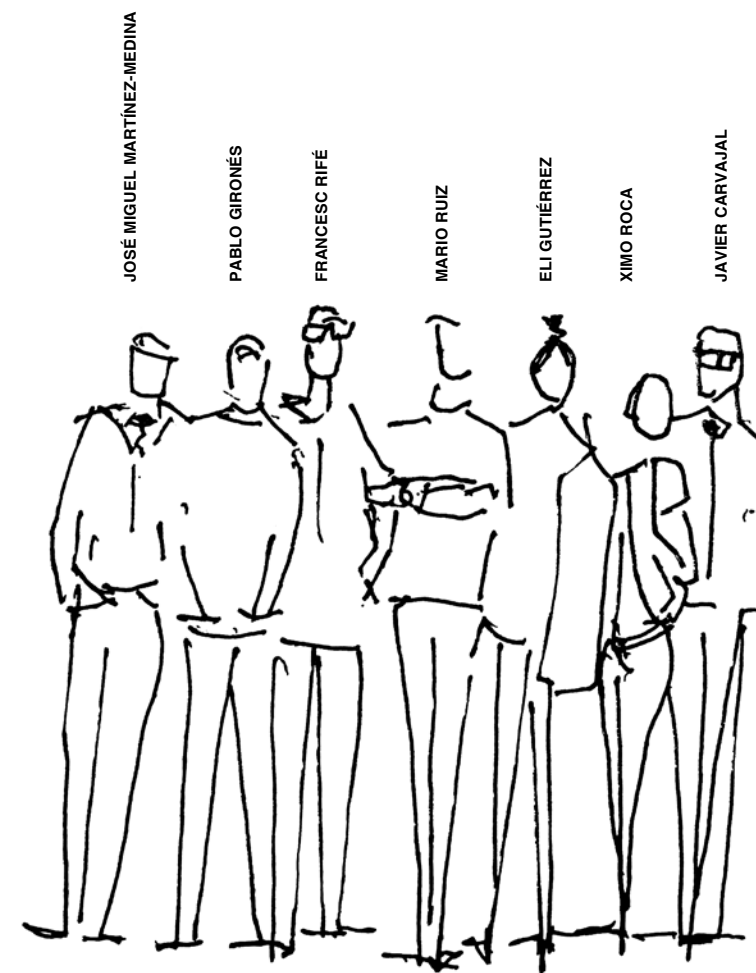

MESAS AUXILIARES / AUXILIARY TABLES



CHRYSLER

José Martínez-Medina



CHR.70-35

70X70 h 35 cm / 14X14h 14 in

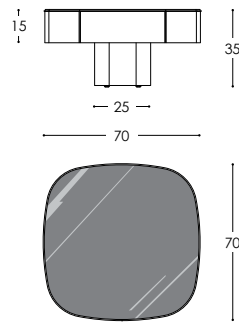

Mesa auxiliar. Tapa de cristal lacado color negro, banda perimetral de acero color, base inferior en acabado laca micro-texturada.

Coffee table. Black lacquered glass top covered with a colored steel stripe. Base lacquered in micro-texturized finish.

ACABADOS: Tapa, en cristal lacado color negro o Neolith Negro Marquina. Banda perimetral en acabado, acero color oro, bronce o negro. Base, en acabado laca micro-texturada.

FINISH: Top, in black lacquered glass or Neolith Marquina Black. Perimetral stripe, black, gold or bronze colored steel. Base, in micro-texturized lacquer finish.

CHR.100-17

70X70 h 17 cm / 14X14h 7 in

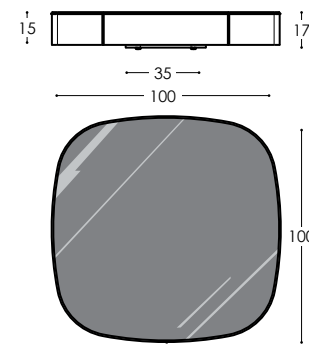

Mesa auxiliar. Tapa de cristal lacado color negro, banda perimetral de acero color, base inferior en acabado laca micro-texturada.

Coffee table. Black lacquered glass top covered with a colored steel stripe. Base lacquered in micro-texturized finish.

ACABADOS: Tapa, en cristal lacado color negro o Neolith Negro Marquina. Banda perimetral en acabado, acero color oro, bronce o negro. Base, en acabado laca micro-texturada.

FINISH: Top, in black lacquered glass or Neolith Marquina Black. Perimetral stripe, black, gold or bronze colored steel. Base, in micro-texturized lacquer finish.

CHR.100-25

100X100 h 25 cm / 39X39 h 10 in

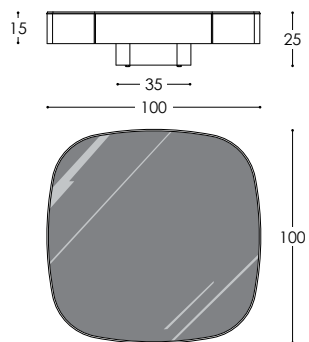

Mesa auxiliar. Tapa de cristal lacado color negro, banda perimetral de acero color, base inferior en acabado laca micro-texturada.

Coffee table. Black lacquered glass top covered with a colored steel stripe. Base lacquered in micro-texturized finish.

ACABADOS: Tapa, en cristal lacado color negro o Neolith Negro Marquina. Banda perimetral en acabado, acero color oro, bronce o negro. Base, en acabado laca micro-texturada.

FINISH: Top, in black lacquered glass or Neolith Marquina Black. Perimetral stripe, black, gold or bronze colored steel. Base, in micro-texturized lacquer finish.

ALIANTE

José Martínez-Medina



ALIANTE

José Martínez-Medina



ALI.70

70X70 h 45 cm / 27X27 h 18 in

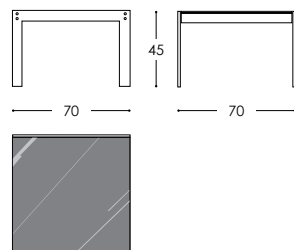

Mesa de esquina. Estructura metálica de pletina de acero calibrada (10mm). Tapa en madera (16mm) o cristal (8mm).

Side table. 10mm calibrated inox sheet metal frame. 16mm solid wood or 8mm glass top.

ACABADOS: Estructura metálica, en acabado Cromo brillo. Tapa madera, en acabado laca micro-texturada o acabado madera. Tapa cristal, en cristal transparente o cristal lacado Negro.

FINISHES: Metal frame in gloss chrome finish. WOOD top in wood finish or micro-texturized lacquer. GLASS top in translucent glass or black lacquer glass.

ALI.100

100X100 h 35 cm / 39X39 h 14 in

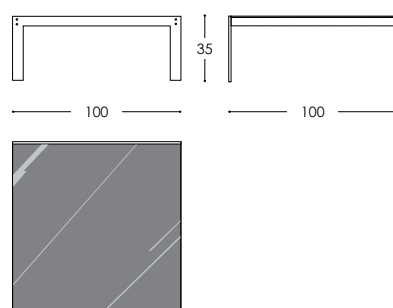

Mesa de centro. Estructura metálica de pletina de acero calibrada (10mm). Tapa en madera (16mm) o cristal (8mm).

Coffee table. 10mm calibrated inox sheet metal frame. 16mm solid wood or 8mm glass top.

ACABADOS: Estructura metálica, en acabado Cromo brillo. Tapa madera, en acabado laca micro-texturada o acabado madera. Tapa cristal, en cristal transparente o cristal lacado Negro.

FINISHES: Metal frame in gloss chrome finish. WOOD top in wood finish or micro-texturized lacquer. GLASS top in translucent glass or black lacquer glass.

ALI.120

120X120 h 35 cm / 47X47 h 14 in

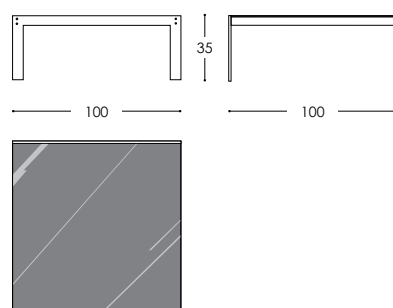

Mesa de centro. Estructura metálica de pletina de acero calibrada (10mm). Tapa en madera (16mm) o cristal (8mm).

Coffee table. 10mm calibrated inox sheet metal frame. 16mm solid wood or 8mm glass top.

ACABADOS: Estructura metálica, en acabado Cromo brillo. Tapa madera, en acabado laca micro-texturada o acabado madera. Tapa cristal, en cristal transparente o cristal lacado Negro.

FINISHES: Metal frame in gloss chrome finish. WOOD top in wood finish or micro-texturized lacquer. GLASS top in translucent glass or black lacquer glass.

NINA

José Martínez-Medina



NN.80

80Ø h 45 cm / 31Ø h 18 in

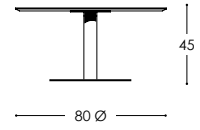

Mesa de centro o esquina. Estructura metálica, compuesta por disco inferior y columna cilíndrica. Tapa circular y contra tapa lacada a juego.

Coffee or side table. Metal frame made of a cilindric column and a circular plate foot. Circular top and matching lacquered undertop.

ACABADOS: Disco inferior, en acabado acero inoxidable satinado. Columna, en acabado Acero Inox. Tapa, en cristal lacado Negro, madera o laca micro-texturada. Contra tapa, en acabado laca micro-texturada.

FINISHES: Foot in inox satin finish. Column in chrome gloss finish. Top in Black lacquered glass, wood or micro-texturized lacquer finish. Undertop in micro-texturized lacquer finish.

NN.120

120Ø h 35 cm / 47Ø h 14 in

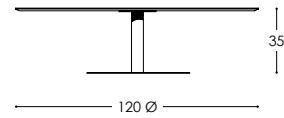

Mesa de centro o esquina. Estructura metálica, compuesta por disco inferior y columna cilíndrica. Tapa circular y contra tapa lacada a juego.

Coffee or side table. Metal frame made of a cilindric column and a circular plate foot. Circular top and matching lacquered undertop.

ACABADOS: Disco inferior, en acabado acero inoxidable satinado. Columna, en acabado Acero Inox. Tapa, en cristal lacado Negro, madera o laca micro-texturada. Contra tapa, en acabado laca micro-texturada.

FINISHES: Foot in inox satin finish. Column in chrome gloss finish. Top in Black lacquered glass, wood or micro-texturized lacquer finish. Undertop in micro-texturized lacquer finish.

MINI TABLE

José Martínez-Medina



MINI TABLE | TÉCNICO

MINI.TB

36X36 h 36 cm / 14X14h 14 in

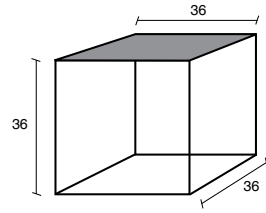

Mesa auxiliar. Estructura de varilla metálica de acero con forma cúbica. Tapa de madera.

Side table. Steel rod structure cube-shaped. Wooden top.

ACABADOS: Estructura metálica, en acabado acero inoxidable arañado. Tapa, en acabado madera o laca micro-texturada.

FINISHES: Metal frame in brushed inox finish. Top in wood finish or micro-texturized finish

TÉ

José Martínez-Medina



T.40
35X33 h 40 cm / 14X13h 16 in

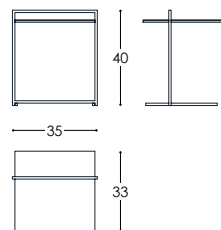

Mesa auxiliar. Estructura de tubo de hierro. Tapa de madera o lacada.

Side table. Iron tube structure. Wooden or lacquered top.

ACABADOS: Estructura metálica, lacada color negro mate. Tapa, en acabado madera o laca micro-texturada.

FINISHES: Metal frame in black micro-texturized lacquer finish. Top in wood finish or micro-texturized finish.

T.50
35X33 h 50 cm / 14X13h 20 in

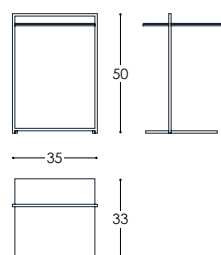

Mesa auxiliar. Estructura de tubo de hierro. Tapa de madera o lacada.

Side table. Iron tube structure. Wooden or lacquered top.

ACABADOS: Estructura metálica, lacada color negro mate. Tapa, en acabado madera o laca micro-texturada.

FINISHES: Metal frame in black micro-texturized lacquer finish. Top in wood finish or micro-texturized finish.

T.60
35X33 h 60 cm / 14X13h 24 in

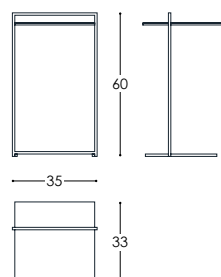

Mesa auxiliar. Estructura de tubo de hierro. Tapa de madera o lacada.

Side table. Iron tube structure. Wooden or lacquered top.

ACABADOS: Estructura metálica, lacada color negro mate. Tapa, en acabado madera o laca micro-texturada.

FINISHES: Metal frame in black micro-texturized lacquer finish. Top in wood finish or micro-texturized finish.

VERÓNICA

José Martínez-Medina



VERÓNICA

José Martínez-Medina



v.20
200 h 60 cm / 80 h 24 in

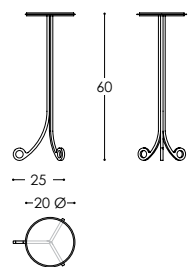

Mesa auxiliar. Estructura metálica. Tapa lacada.

Auxiliary table. Metal structure. Lacquered top.

ACABADOS: Estructura metálica, acabado laca MATE. Tapa, en acabado laca BRILLO.

FINISHES: Metallic structure, micro-texturized lacquer MATT. Top lacquered gloss

V.30
300 h 35 cm / 120 h 14 in

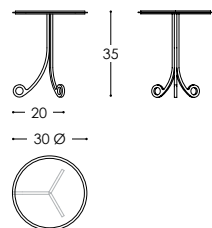

Mesa auxiliar. Estructura metálica. Tapa lacada.

Auxiliary table. Metal structure. Lacquered top.

ACABADOS: Estructura metálica, acabado laca MATE. Tapa, en acabado laca BRILLO.

FINISHES: Metallic structure, micro-texturized lacquer MATT. Top lacquered gloss

V.60
300 h 35 cm / 120 h 14 in

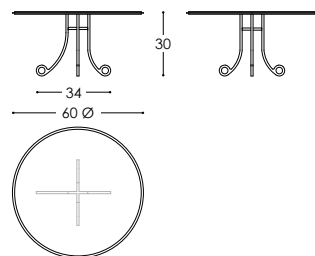

Mesa auxiliar. Estructura metálica. Tapa lacada.

Auxiliary table. Metal structure. Lacquered top.

ACABADOS: Estructura metálica, acabado laca MATE. Tapa, en acabado laca BRILLO.

FINISHES: Metallic structure, micro-texturized lacquer MATT. Top lacquered gloss

V.90
900 h 70 cm / 350 h 27 in

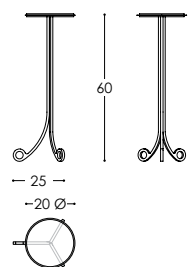

Mesa auxiliar. Estructura metálica. Tapa lacada.

Auxiliary table. Metal structure. Lacquered top.

ACABADOS: Estructura metálica, acabado laca MATE. Tapa, en acabado laca BRILLO.

FINISHES: Metallic structure, micro-texturized lacquer MATT. Top lacquered gloss

FUSTE

José Martínez-Medina



F.55
55X55 h 58 cm / 22X22 h 23 in

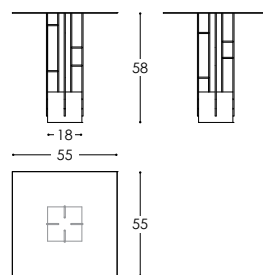

Mesa auxiliar. Estructura metálica y peana inferior. Tapa lacada.

Auxiliary table. Metal structure and lower base. Lacquered top.

ACABADOS: Estructura metálica, en acabado laca MATE. Tapa y peana inferior, en acabado laca BRILLO.

FINISHES: Metallic structure and base, micro-texturized lacquer MATT. Top lacquered gloss

F.45
45X45 h 48 cm / 18X18 h 19 in

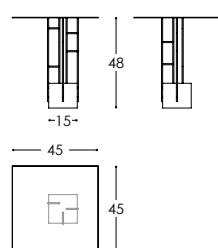

Mesa auxiliar. Estructura metálica y peana inferior. Tapa lacada.

Auxiliary table. Metal structure and lower base. Lacquered top.

ACABADOS: Estructura metálica, en acabado laca MATE. Tapa y peana inferior, en acabado laca BRILLO.

FINISHES: Metallic structure and base, micro-texturized lacquer MATT. Top lacquered gloss

F.25
25X70 h 33 cm / 10X27 h 13 in

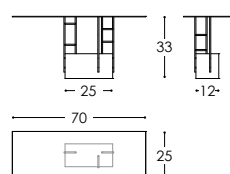

Mesa auxiliar. Estructura metálica y peana inferior. Tapa lacada.

Auxiliary table. Metal structure and lower base. Lacquered top.

ACABADOS: Estructura metálica, en acabado laca MATE. Tapa y peana inferior, en acabado laca BRILLO.

FINISHES: Metallic structure and base, micro-texturized lacquer MATT. Top lacquered gloss



RUFINA

José Martínez-Medina



RUFINA | TÉCNICO

R.210

210X125 h 25 cm / 83X49 h 10 in

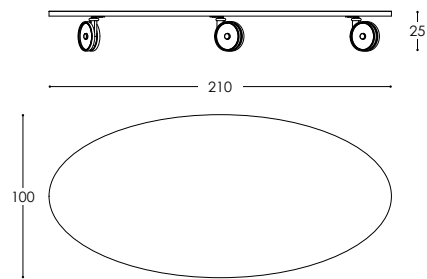

Mesa de centro. Compuesta por una tapa superior con forma elíptica, en acabado madera. Apoyada sobre 6 RUEDAS de gran tamaño.

Side table. Composed by a top cover in SOLID WOOD with an elliptical shape. Supported on six large WHEELS.

ACABADOS: Tapa superior, acabado MADERA o laca micro-texturada. Ruedas, color negro.

FINISHES: Top cover, NATURAL WOOD or micro-texturized lacquer. Wheels, black color.



ALMACENAJE / STORAGE



CAJONERAS / PEDESTALS

KBES

José Martínez-Medina



KBS-3C

43X60 h 61 cm / 17X24 h 24 in

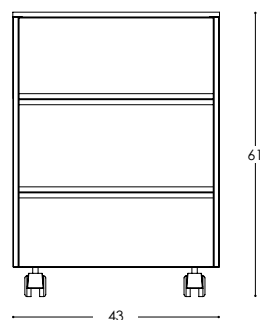

Cajonera de tres cajones, con ruedas. Sin tiradores. Nos permite combinar distintos acabados para envolverte, trasera y frentes

Three-drawer unit with castors. No handles or pulls. Customizable unit, allows different finish combination finishes on fronts, back and sides.

ACABADOS: Envolverte, en acabados madera o laca micro-texturada. Frentes y trasera, laca micro-texturada.

FINISHES: Unit, in wood finish or micro-texturized lacquer. Front and back, in micro-texturized lacquer.

KBS-AR

43X60 h 61 cm / 17X24 h 24 in

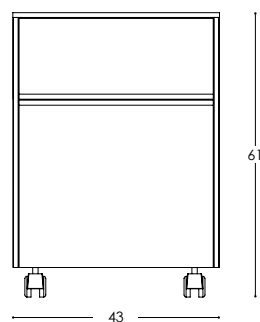

Cajonera de un cajón y archivo, con ruedas. Sin tiradores. Nos permite combinar distintos acabados para envolverte, trasera y frentes.

One-drawer and archive unit with castors. No handles or pulls. Customizable unit, allows different finish combination finishes on fronts, back and sides.

ACABADOS: Envolverte, en acabados madera o laca micro-texturada. Frentes y trasera, laca micro-texturada.

FINISHES: Unit, in wood finish or micro-texturized lacquer. Front and back, in micro-texturized lacquer.

PTF

José Martínez-Medina



PTF.90

90X60 h 61 cm / 35X24 h 24 in

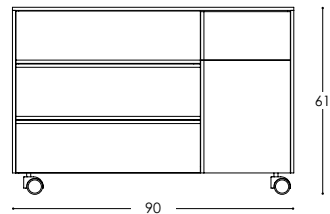

Cajonera de tres cajones y puerta, con ruedas. Sin tiradores. En el interior del cajón superior encontramos un cajón interno/plumier, en madera de haya natural y frontera lacada. Espacio de puerta pensado para alojar una papelerera (no incluida), accesible mediante una pequeña puerta abatible.

Three-drawer and one-door unit with castors. No handles or pulls. Inside the top drawer there is a pencil tray lacquered at the front and finished in natural wood. Container space behind door to fit a basket bin (not included) with access through a small flap door.

ACABADOS: Envolverte, en acabado madera o laca micro-texturada. Frentes y trasera, laca micro-texturada.

FINISHES: Unit, in wood finish or micro-texturized lacquer. Front and back, in micro-texturized lacquer.

PTF.90 CPU

90X60 h 61 cm / 35X24 h 24 in

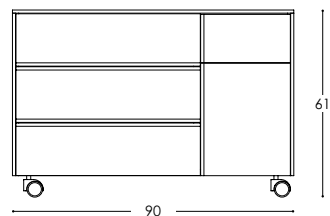

Cajonera de tres cajones y puerta, con ruedas. Sin tiradores. En el interior del cajón superior encontramos un cajón interno/plumier, en madera de haya natural y frontera lacada. Espacio de puerta pensado para alojar una CPU.

Three-drawer and one-door unit with castors. No handles or pulls. Inside the top drawer there is a pencil tray lacquered at the front and finished in natural wood. Container space behind door to fit a CPU (not included).

ACABADOS: Envolverte, en acabado madera o laca micro-texturada. Frentes y trasera, laca micro-texturada.

FINISHES: Unit, in wood finish or micro-texturized lacquer. Front and back, in micro-texturized lacquer.

PTF.60

61,5X60 h 61 cm / 24X24 h 24 in

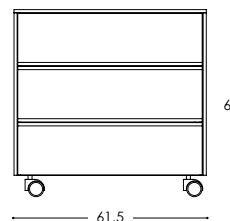

Cajonera de tres cajones, con ruedas. Sin tiradores. En el interior del cajón superior encontramos un cajón interno/plumier, en madera de haya natural y frontera lacada.

Three-drawer unit with castors. No handles or pulls. Inside the top drawer there is a pencil tray lacquered at the front and finished in natural wood.

ACABADOS: Envolverte, en acabado madera o laca micro-texturada. Frentes y trasera, laca micro-texturada.

FINISHES: Unit, in wood finish or micro-texturized lacquer. Front and back, in micro-texturized lacquer.

PTF.100-2C

100X60 h 49 cm / 39X24 h 19 in

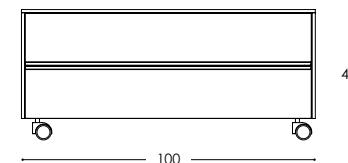

Cajonera de dos cajones, sin tiradores. Con ruedas.

Two-drawer unit with castors. No handles or pulls.

ACABADOS: Envolverte, en acabado madera o laca micro-texturada. Frentes y trasera, laca micro-texturada.

FINISHES: Unit, in wood finish or micro-texturized lacquer. Front and back, in micro-texturized lacquer.

MIX ROULOTTE

José Martínez-Medina



MIX.R-100

102x53 h 59 / 40X21 h 23 in



Cajonera de tres cajones, con ruedas. Entrepaño metálico de separación entre cajones. Cajones internos en madera de haya natural.

Three-drawer unit with castors. No handles or pulls. Metal space divider between drawers. Interior drawers finished in natural wood.

ACABADOS: Módulo interior, en acabado laca micro-texturada. Frente cajones, sobre tapa y costados, en acabado madera o laca micro-texturada. Entrepaños, en acabado Cromo brillo.

FINISHES: Interior surfaces of unit in micro-texturized lacquer. Drawer fronts, top and sides in wood finish or micro-texturized lacquer. Space dividers in chrome gloss finish.

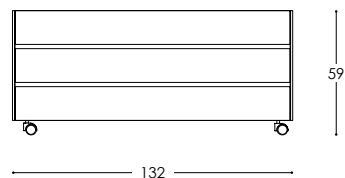

Cajonera de tres cajones, con ruedas. Entrepaño metálico de separación entre cajones. Cajones internos en madera de haya natural.

Three-drawer unit with castors. No handles or pulls. Metal space divider between drawers. Interior drawers finished in natural wood.

ACABADOS: Módulo interior, en acabado laca micro-texturada. Frente cajones, sobre tapa y costados, en acabado madera o laca micro-texturada. Entrepaños, en acabado Cromo brillo.

FINISHES: Interior surfaces of unit in micro-texturized lacquer. Drawer fronts, top and sides in wood finish or micro-texturized lacquer. Space dividers in chrome gloss finish.

AX

José Martínez-Medina

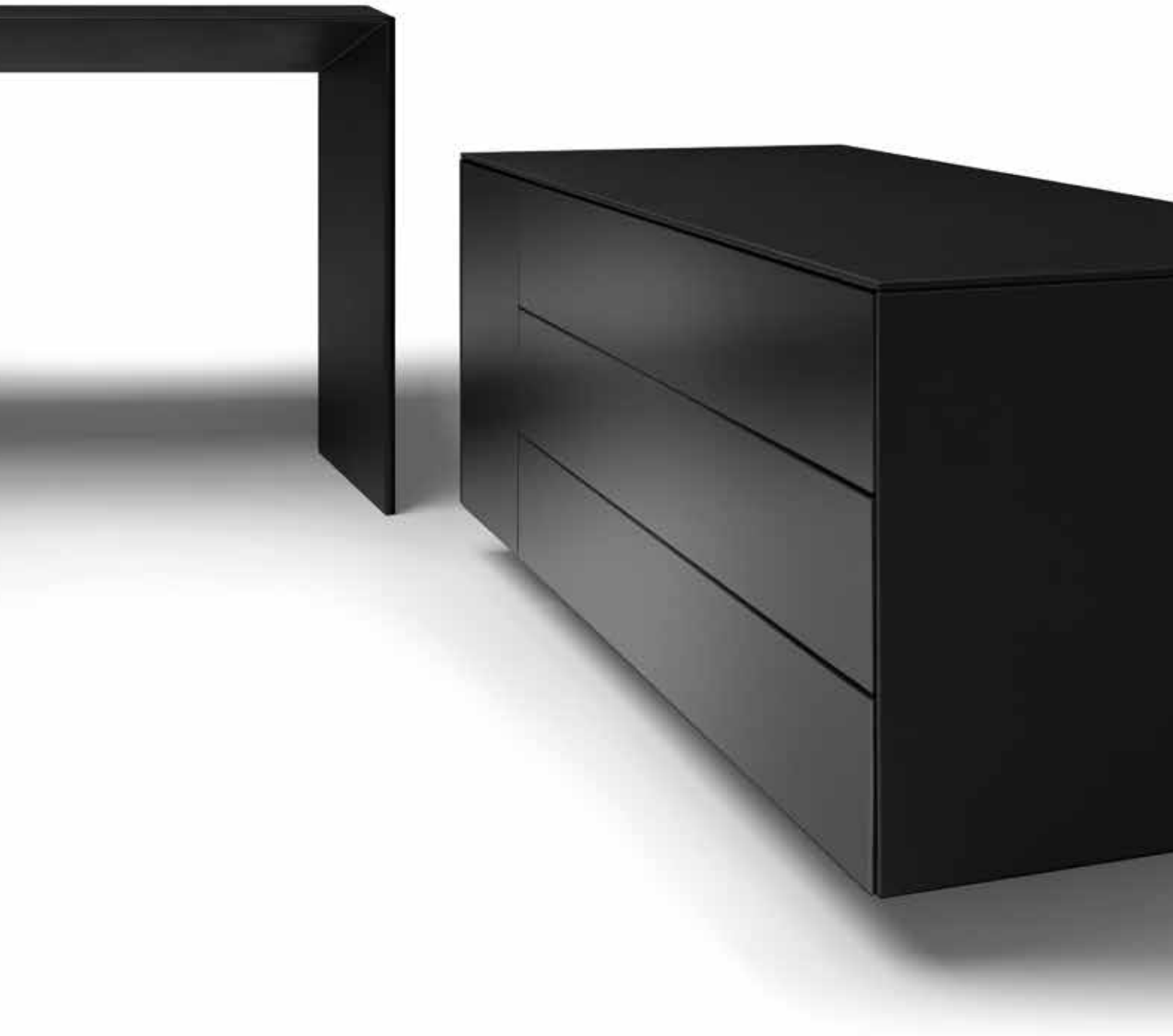

AX.120

120X55 h 55 cm / 47X22 h 22 in

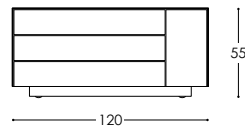

Cajonera de tres cajones y puerta, con ruedas ocultas. Sistema de apertura push en cajones.

Three-drawer and one-door unit with hidden castors. With hidden lock. Push opening system in drawers.

ACABADOS Envolvente, tapizado en Piel-Tech. Frente y trasera, acero inox color negro.

FINISHES: Unit in Tech-Leather. Front & back in color Stainless Steel.



ALMACENAJE HORIZONTAL / HORIZONTAL STORAGE



BIS 75

José Martínez-Medina



BS.75-P

90X44 h 75 cm / 35X17 h 29 in

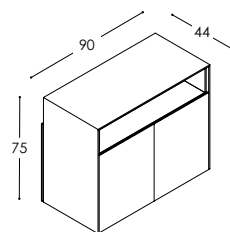

Contenedor horizontal. Compuesto por 2 puertas y hueco diáfano superior. Equipado con freno en bisagras para cierre amortiguado silencioso (sin golpe). Deslizantes inferiores nivelables.

Horizontal container. Top open space and two-door unit. Silent door closure. Equipped with integrated soft close hinge mechanism. Adjustable sliding glides.

ACABADOS: Envoltente y trasera, en acabado laca micro-texturada. Puertas, en acabado laca BRILLO. Tapa intermedia y estante interior, en acabado madera.

FINISHES: Sides and back, in micro-texturized lacquer finish. Doors in lacquer GLOSS finish. Shelving in wood finish.

BS.75-D

90X44 h 75 cm / 35X17 h 29 in

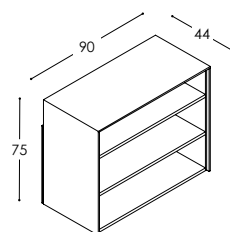

Contenedor horizontal diáfano. Compuesto por estante regulable en altura y hueco diáfano superior. Deslizantes inferiores nivelables.

Horizontal open container. Equipped with height regulated shelving and top open space. Adjustable sliding glides.

ACABADOS: Envoltente y trasera, en acabado laca micro-texturada. Tapa intermedia y estante interior, en acabado madera.

FINISHES: Sides and back in micro-texturized lacquer finish. Shelving in wood finish.



H-MIX

José Martínez-Medina



H-MIX

José Martínez-Medina



H-MIX

José Martínez-Medina



H-MIX

José Martínez-Medina



H.MIX.70-P

69X53 h 65 cm / 27X21 h 26 in

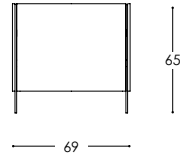

Contenedor horizontal de 1 puerta. Compuesto por un módulo (65 cm) de 1 puerta, porterías y costados finales. Interior equipado con estante regulable en altura.

One-door horizontal container. Unit elements: 65cm width one-door unit, door front and sides. Equipped with a height adjustable shelf.

ACABADOS: Módulo interior y estante, en acabado laca micro-texturada. Frente, tapa y costados, en acabado madera o laca micro-texturada. Porterías metálicas, en acabado Cromo brillo.

FINISHES: Interior surfaces of unit and shelf in micro-texturized lacquer. Front, top and sides in beech wood finish or micro-texturized lacquer. Metal door frames in gloss chrome finish.

H.MIX.70-C

69X53 h 65 cm / 27X21 h 26 in

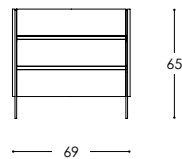

Contenedor horizontal de 3 cajones. Compuesto por un módulo (65 cm) de 3 cajones, porterías y costados finales. Cajones interiores en madera de haya natural.

Three-drawer horizontal container. Unit elements: 65cm width three-drawer unit, drawer fronts and sides. Interior surfaces of drawers in natural beech wood finish.

ACABADOS: Módulo interior, en acabado laca micro-texturada. Frente, tapa y costados, en acabado madera o laca micro-texturada. Porterías metálicas y entrepaños, en acabado Cromo brillo.

FINISHES: Interior surfaces of unit in micro-texturized lacquer. Front, top and sides in beech wood finish or micro-texturized lacquer. Metal legs and space dividers in gloss chrome finish.

H.MIX.105-P

104X53 h 65 cm / 41X21 h 26 in

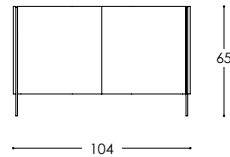

Contenedor horizontal de 2 puertas. Compuesto por un módulo (100 cm) de 2 puertas, porterías y costados finales. Interior dividido en dos zonas, lado izquierdo (de menor tamaño) y lado derecho, con estante regulable en altura.

Two-door horizontal container. Unit elements: 100cm width two-door unit, door fronts and sides. Divided inside in two areas, a smaller left hand side and a right hand side with a height adjustable shelf.

ACABADOS: Módulo interior y estantes, en acabado laca micro-texturada. Frente, tapa y costados, en acabado madera o laca micro-texturada. Porterías metálicas, en acabado Cromo brillo.

FINISHES: Interior surfaces of unit and shelf in micro-texturized lacquer. Front, top and sides in beech wood finish or micro-texturized lacquer. Metal legs in gloss chrome finish.

H.MIX.105-C

104X53 h 65 cm / 41X21 h 26 in

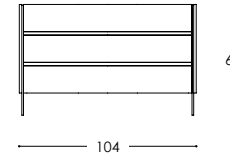

Contenedor horizontal de 3 cajones. Compuesto por un módulo (100 cm) de 3 cajones, porterías y costados finales. Cajones interiores en madera de haya natural.

Three-drawer horizontal container. Unit elements: 100cm width three-drawer unit, drawer fronts and sides. Interior surfaces of drawers in natural beech wood finish.

ACABADOS: Módulo interior, en acabado laca micro-texturada. Frente, tapa y costados, en acabado madera o laca micro-texturada. Porterías metálicas y entrepaños, en acabado Cromo brillo.

FINISHES: Interior surfaces of unit in micro-texturized lacquer. Front, top and sides in wood finish or micro-texturized lacquer. Metal legs and space dividers in gloss chrome finish.

H.MIX.135-P

134X53 h 65 cm / 53X21 h 26 in

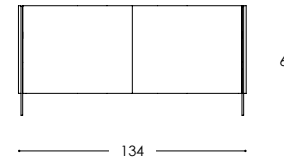

Contenedor horizontal de 2 puertas. Compuesto por un módulo (130 cm) de 2 puertas, porterías y costados finales. Interior dividido en dos zonas, con estante regulable en altura a cada lado.

Two-door horizontal container. Unit elements: 130cm width two-door unit, door fronts and sides. Divided inside in two areas with a height adjustable shelf on each hand side.

ACABADOS: Módulo interior y estantes, en acabado laca micro-texturada. Frente, tapa y costados, en acabado madera o laca micro-texturada. Porterías metálicas, en acabado Cromo brillo.

FINISHES: Interior surfaces and shelves in micro-texturized lacquer. Front, top and sides in wood finish or micro-texturized lacquer. Metal legs in gloss chrome finish.

H.MIX.135-C

134X53 h 65 cm / 53X21 h 26 in

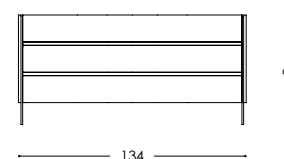

Contenedor horizontal de 3 cajones. Compuesto por un módulo (130 cm) de 3 cajones, porterías y costados finales. Cajones interiores en madera de haya natural.

Three-drawer horizontal container. Unit elements: 130cm width three-drawer unit, drawer fronts and sides. Interior surfaces of drawers in natural beech wood finish.

ACABADOS: Módulo interior, en acabado laca micro-texturada. Frente, tapa y costados, en acabado madera o laca micro-texturada. Porterías metálicas y entrepaños, en acabado Cromo brillo.

FINISHES: Interior surfaces of unit in micro-texturized lacquer. Front, top and sides in wood finish or micro-texturized lacquer. Metal legs and space dividers in gloss chrome finish.

MIX COMPONIBLE | TÉCNICO

MIX.65-P

69X53 h 52 cm / 27X21 h 20 in

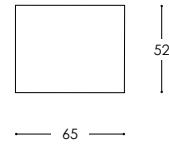

Módulo de 1 puerta. Interior con estante regulable en altura.

One-door horizontal container. Height adjustable shelf.

ACABADOS: Módulo interior y estante, en acabado laca micro-texturada. Puerta, en acabado madera o laca micro-texturada.

FINISHES: Interior surfaces and shelf in micro-texturized lacquer. Door in natural beech wood finish or micro-texturized lacquer.

MIX.65-C

69X53 h 52 cm / 27X21 h 20 in

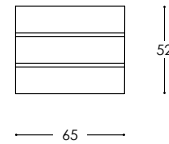

Módulo de 3 cajones. Cajones interiores en madera de haya natural. Guías ocultas, con auto cierre y amortiguación.

Three-drawer horizontal container. Interior surfaces of drawers in natural beech wood finish. Concealed runners with soft-closing mechanism.

ACABADOS: Módulo interior, en acabado laca micro-texturada. Fronteras, en acabado madera o laca micro-texturada. Entrepaños metálicos, en acabado Cromo brillo.

FINISHES: Interior surfaces of unit in micro-texturized lacquer. Fronts in wood finish or micro-texturized lacquer. Space dividers in gloss chrome finish.

MIX.100-P

100X53 h 52 cm / 39X21 h 20 in

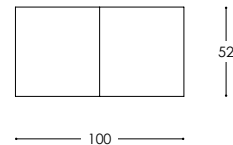

Módulo de 2 puertas. Interior dividido en dos zonas, lado izquierdo (de menor tamaño) y lado derecho, con estante regulable en altura.

Two-door horizontal container. Divided inside into two areas, with a height adjustable shelf.

ACABADOS: Módulo interior y estantes, en acabado laca micro-texturada. Puertas, en acabado madera o laca micro-texturada.

FINISHES: Interior surfaces and shelf in micro-texturized lacquer. Doors in natural wood finish or gloss chrome finish.

MIX.100-P

100X53 h 52 cm / 39X21 h 20 in

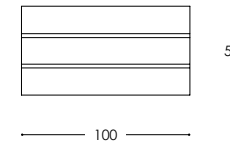

Módulo de 3 cajones. Cajones interiores en madera de haya natural. Guías ocultas, con auto cierre y amortiguación.

Three-drawer unit. Interior surfaces of drawers in natural beech wood finish. Concealed runners with soft-closing mechanism.

ACABADOS: Módulo interior, en acabado laca micro-texturada. Fronteras, en acabado madera o laca micro-texturada. Entrepaños metálicos, en acabado Cromo brillo.

FINISHES: Interior surfaces of unit in micro-texturized lacquer. Drawer fronts in natural wood finish or gloss chrome finish. Metal space dividers in gloss chrome finish.

MIX.130-P

130X53 h 52 cm / 51X21 h 20 in

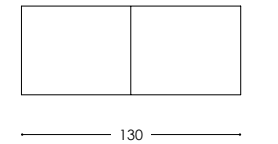

Módulo de 2 puertas. Interior dividido en dos zonas, con estante regulable en altura a cada lado.

Two-door unit. Divided inside into two areas with two height adjustable shelves, one on each side.

ACABADOS: Módulo interior y estantes, en acabado laca micro-texturada. Puertas, en acabado madera o laca micro-texturada.

FINISHES: Interior surfaces and shelf in micro-texturized lacquer. Doors in natural wood finish or gloss chrome finish.

MIX.130-C

130X53 h 52 cm / 51X21 h 20 in

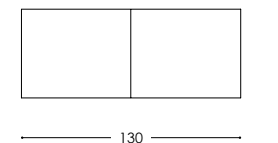

Módulo de 3 cajones. Cajones interiores en acabado madera de haya natural. Guías ocultas, con auto cierre y amortiguación.

Three-drawer unit. Interior surfaces of drawers in natural beech wood finish. Concealed runners with soft-closing mechanism.

ACABADOS: Módulo interior, en acabado laca micro-texturada. Fronteras, en acabado madera o laca micro-texturada. Entrepaños metálicos, en acabado Cromo brillo.

FINISHES: Interior surfaces of unit in micro-texturized lacquer. Drawer fronts in natural wood finish or gloss chrome finish. Metal space dividers in gloss chrome finish.

MIX.TS-65

130X53 h 52 cm / 51X21 h 20 in

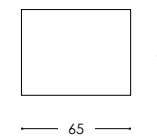

Sobretapa para módulo mix de 65 cm. En acabado madera o laca micro-texturada.

65cm top for mix unit. In wood finish or micro-texturized lacquer

MIX COMPONIBLE | TÉCNICO

MIX.65-C

65X51 h 0,8 cm / 26X20 h 0,3 in

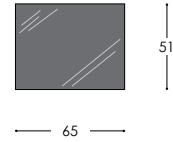

Sobretapa para módulo mix de 65 cm. En cristal de 8 mm lacado en color negro.

65 cm top for mix unit. In 8mm glass black colour lacquered.

MIX-PO

1X50 h 64,5 cm / 0,4X20 h 25 in

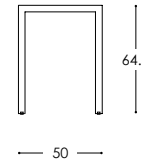

Portería Mix. Estructura metálica de pletina calibrada en acabado Cromo Brillo. Mini niveladores en su base.

Mix legs. Metal frame in calibrated gloss chrome finish sheet metal. Mini adjustable feet at the base.

MIX.T-100

100X51 h 2 cm / 39X20 h 0,8 in

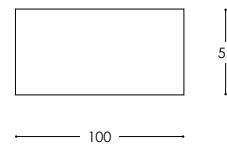

Sobretapa para módulo mix de 100 cm. En acabado madera o laca micro-texturada.

100 cm top for mix unit. In wood finish or micro-texturized lacquer.

MIX-CF

1X53 h 52 cm / 0,4X21 h 20 in

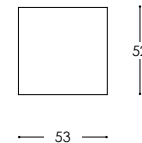

Pareja de costados finales para composición Mix. En acabado madera o laca micro-texturada.

Couple of side boards for Mix configurations. In wood finish or micro-texturized lacquer.

MIX.T-100-C

100X51 h 0,8 cm / 39X20 h 0,3 in

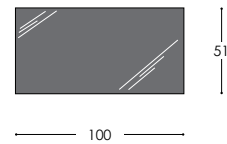

Sobretapa para módulo mix de 100 cm. En acabado madera o laca micro-texturada.

100 cm top for mix unit. In wood finish or micro-texturized lacquer.

MIX-C1

170X53 h 65 cm / 67X21 h 25 in

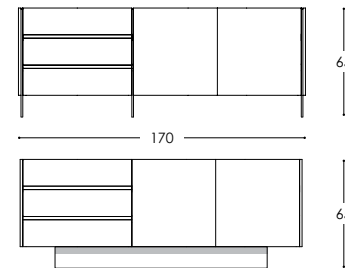

Composición 01. Contenedor horizontal compuesto por: módulo (65 cm 3 cajones) y módulo (100 cm 2 puertas).

Composition 01. Horizontal container elements: 65cm width three-drawer unit and 100cm width two-door unit.

MIX.T-130

130X51 h 2 cm / 51X20 h 0,8 in



Sobretapa para módulo mix de 130 cm. En cristal de 8 mm lacado en color negro.

130 cm top for mix unit. In 8mm glass black colour lacquered.

MIX-C3

170X53 h 65 cm / 67X21 h 25 in

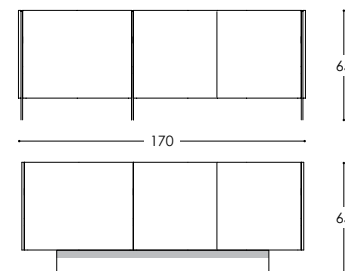

Composición 03. Contenedor horizontal compuesto por: módulo (100 cm 2 puertas) y módulo (65 cm de 1 puerta).

Composition 03. Horizontal container elements: 100cm width two-door unit and 65cm width one-door unit.

MIX.T-130-C

130X51 h 0,8 cm / 51X20 h 0,3 in

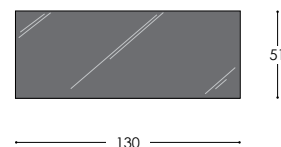

Sobretapa para módulo mix de 130 cm. En cristal de 8 mm lacado en color negro.

130 cm top for mix unit. In 8mm glass black colour lacquered.

ACABADOS: Módulos interiores, en acabado laca micro-texturada. Frente y costados, en acabado madera o laca micro-texturada. Tapa, en acabado madera, laca micro-texturada o cristal negro. Tipo A. Porterías metálicas, en acabado Cromo brillo. Tipo B. Zócalo, en acabado laca micro-texturada.

FINISHES: Interior surfaces of unit in micro-texturized lacquer. Fronts and sides in natural wood finish or micro-texturized lacquer. Top in natural wood finish, micro-texturized lacquer or black glass. Type A. Metal legs in gloss chrome finish. Type B. Base board, in micro-texturized lacquer.

MIX-C5

200X53 h 65 cm / 79X21 h 25 in

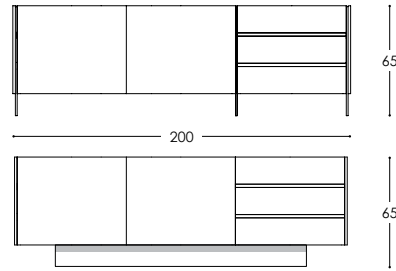

Composición 05. Contenedor horizontal compuesto por: módulo (65 cm de 3 cajones) y módulo (130 cm de 2 puertas).

Composition 05. Horizontal container elements: 65cm width three-drawer unit and 130cm width two-door unit.

ACABADOS: Módulos interiores, en acabado laca micro-texturada. Frente y costados, en acabado madera o laca micro-texturada. Tapa, en acabado madera, laca micro-texturada o cristal negro. Entrepaños metálicos, en acabado Cromo brillo. Tipo A. Porterías metálicas, en acabado Cromo brillo. Tipo B. Zócalo, en acabado laca micro-texturada.

FINISHES: Interior surfaces of unit in micro-texturized lacquer. Fronts and sides in natural wood finish or micro-texturized lacquer. Top in natural wood finish, micro-texturized lacquer or black glass. Metal details between drawers, in gloss chrome finish. Type A. Metal legs in gloss chrome finish. Type B. Base board, in micro-texturized lacquer.

MIX-C6

200X53 h 65 cm / 79X21 h 25 in

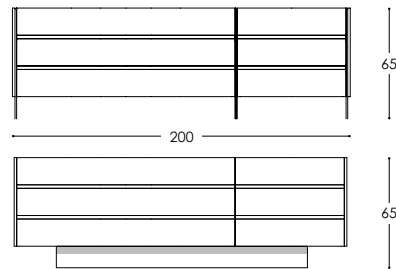

Composición 06. Contenedor horizontal compuesto por: módulo (65 cm de 3 cajones) y módulo (130 cm de 3 cajones).

Composition 06. Horizontal container elements: 65cm width three-drawer unit and 130cm width three-drawer unit.

ACABADOS: Módulos interiores, en acabado laca micro-texturada. Frente y costados, en acabado madera o laca micro-texturada. Tapa, en acabado madera, laca micro-texturada o cristal negro. Entrepaños metálicos, en acabado Cromo brillo. Tipo A. Porterías metálicas, en acabado Cromo brillo. Tipo B. Zócalo, en acabado laca micro-texturada.

FINISHES: Interior surfaces of unit in micro-texturized lacquer. Fronts and sides in natural wood finish or micro-texturized lacquer. Top in natural wood finish, micro-texturized lacquer or black glass. Metal details between drawers, in gloss chrome finish. Type A. Metal legs in gloss chrome finish. Type B. Base board, in micro-texturized lacquer.

MIX-C7

200X53 h 65 cm / 79X21 h 25 in

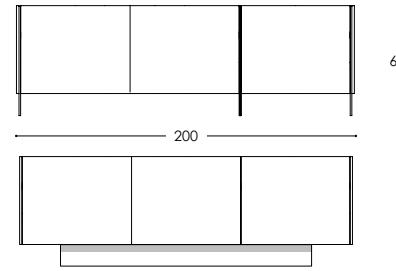

Composición 07. Contenedor horizontal compuesto por: módulo (65 cm de 1 puerta) y módulo (130 cm de 2 puertas).

Composition 07. Horizontal container elements: 65cm width one-door unit and 130cm width two-door unit.

ACABADOS: Módulos interiores, en acabado laca micro-texturada. Frente y costados, en acabado madera o laca micro-texturada. Tapa, en acabado madera, laca micro-texturada o cristal negro. Tipo A. Porterías metálicas, en acabado Cromo brillo. Tipo B. Zócalo, en acabado laca micro-texturada.

FINISHES: Interior surfaces of unit in micro-texturized lacquer. Fronts and sides in natural wood finish or micro-texturized lacquer. Top in natural wood finish, micro-texturized lacquer or black glass. Type A. Metal legs in gloss chrome finish. Type B. Base board, in micro-texturized lacquer.

MIX-C10

266X53 h 65 cm / 105X21 h 25 in

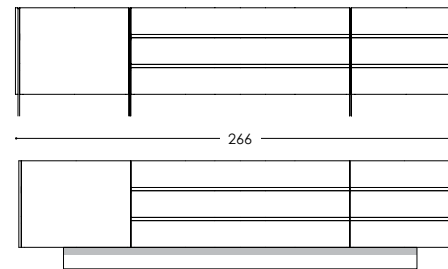

Composición 10. Contenedor horizontal compuesto por: módulo (65 cm de 1 puerta), módulo (65 cm de 3 cajones) y módulo (130 cm de 3 cajones).

Composition 10. Horizontal container elements: 65cm width one-door unit, 65cm width three-drawer/archive unit and 130cm three-drawer unit.

ACABADOS: Módulos interiores, en acabado laca micro-texturada. Frente y costados, en acabado madera o laca micro-texturada. Tapa, en acabado madera, laca micro-texturada o cristal negro. Entrepaños metálicos, en acabado Cromo brillo. Tipo A. Porterías metálicas, en acabado Cromo brillo. Tipo B. Zócalo, en acabado laca micro-texturada.

FINISHES: Interior surfaces of unit in micro-texturized lacquer. Fronts and sides in natural wood finish or micro-texturized lacquer. Top in natural wood finish, micro-texturized lacquer or black glass. Metal details between drawers, in gloss chrome finish. Type A. Metal legs in gloss chrome finish. Type B. Base board, in micro-texturized lacquer.

MIX-C11

271X53 h 65 cm / 107X21 h 25 in

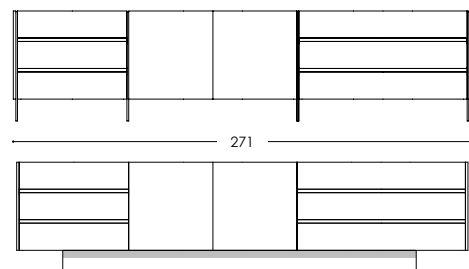

Composición 11. Contenedor horizontal compuesto por: módulo (65 cm de 3 cajones), módulo (100 cm de 3 cajones) y módulo (100 cm de 2 puertas).

Composition 11. Horizontal container elements: 65cm width three-door unit, 100cm width three-drawer unit and 100cm two-door unit.

ACABADOS: Módulos interiores, en acabado laca micro-texturada. Frente y costados, en acabado madera o laca micro-texturada. Tapa, en acabado madera, laca micro-texturada o cristal negro. Entrepaños metálicos, en acabado Cromo brillo. Tipo A. Porterías metálicas, en acabado Cromo brillo. Tipo B. Zócalo, en acabado laca micro-texturada.

FINISHES: Interior surfaces of unit in micro-texturized lacquer. Fronts and sides in natural wood finish or micro-texturized lacquer. Top in natural wood finish, micro-texturized lacquer or black glass. Metal details between drawers, in gloss chrome finish. Type A. Metal legs in gloss chrome finish. Type B. Base board, in micro-texturized lacquer.

MIX-C12

271X53 h 65 cm / 107X21 h 25 in

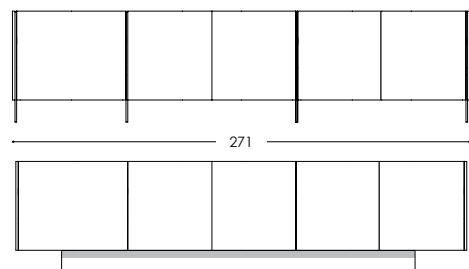

Composición 12. Contenedor horizontal compuesto por: módulo (65 cm de 1 puerta) y 2 módulos (100 cm de 2 puertas).

Composition 12. Horizontal container elements: 65cm width one-door unit and two 100cm width two-door units.

ACABADOS: Módulos interiores, en acabado laca micro-texturada. Frente y costados, en acabado madera o laca micro-texturada. Tapa, en acabado madera, laca micro-texturada o cristal negro. Tipo A. Porterías metálicas, en acabado Cromo brillo. Tipo B. Zócalo, en acabado laca micro-texturada.

FINISHES: Interior surfaces of unit in micro-texturized lacquer. Fronts and sides in natural wood finish or micro-texturized lacquer. Top in natural wood finish, micro-texturized lacquer or black glass. Type A. Metal legs in gloss chrome finish. Type B. Base board, in micro-texturized lacquer.

MIX-C13

336X53 h 65 cm / 132X21 h 25 in

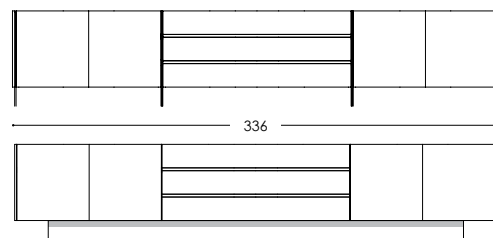

Composición 13. Contenedor horizontal compuesto por: módulo (130 cm de 3 cajones) y 2 módulos (100 cm de 2 puertas).

Composition 13. Horizontal container elements: 130cm width three-drawer unit, and two 100cm width two-door unit.

ACABADOS: Módulos interiores, en acabado laca micro-texturada. Frente y costados, en acabado madera o laca micro-texturada. Tapa, en acabado madera, laca micro-texturada o cristal negro. Entrepaños metálicos, en acabado Cromo brillo. Tipo A. Porterías metálicas, en acabado Cromo brillo. Tipo B. Zócalo, en acabado laca micro-texturada.

FINISHES: Interior surfaces of unit in micro-texturized lacquer. Fronts and sides in natural wood finish or micro-texturized lacquer. Top in natural wood finish, micro-texturized lacquer or black glass. Metal details between drawers, in gloss chrome finish. Type A. Metal legs in gloss chrome finish. Type B. Base board, in micro-texturized lacquer.

COTA

José Martínez-Medina



COTA

José Martínez-Medina



COTA

José Martínez-Medina



COTA.01
120X37 h 60 cm / 47X14 h 24 in

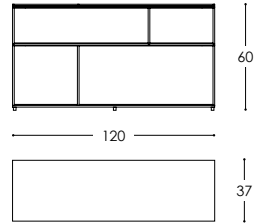

Mueble estantería. Compuesto por estructura metálica con niveladores. Sobre esta estructura se colocan los estantes y unas traseras deslizantes intercambiables.

Shelving unit. Metal frame with adjustable feet. The shelves and the sliding back interchangeable panels are laid over the frame.

ACABADOS: Estructura metálica y estantes, en acabado laca micro-texturada. Traseras, en acabado madera o laca micro-texturada.

FINISHES: Metal frame and shelves in micro-texturized lacquer. Back unit in wood finish or micro-texturized lacquer.

COTA.02
120X37 h 120 cm / 47X14 h 47 in

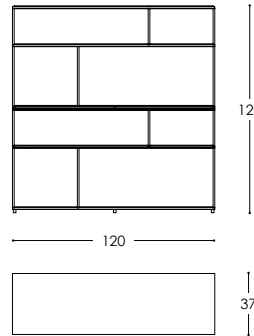

Mueble estantería. Compuesto por 2 estructuras metálicas superpuestas y encajadas una sobre otra. Sobre estas estructuras se colocan los estantes y unas traseras deslizantes intercambiables.

Shelving unit. Two metal frames, one fitted on top of the other. The shelves and the sliding back interchangeable panels are laid over the frame.

ACABADOS: Estructura metálica y estantes, en acabado laca micro-texturada. Traseras, en acabado madera o laca micro-texturada.

FINISHES: Metal frame and shelves in micro-texturized lacquer. Back unit in wood finish or micro-texturized lacquer.

COTA.03
120X37 h 300 cm / 47X14 h 118 in

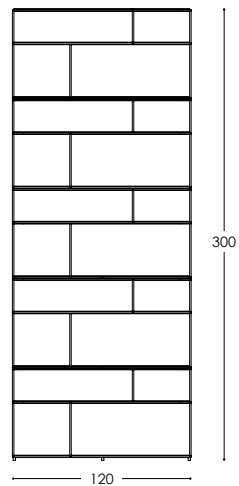

Mueble estantería. Compuesto por 5 estructuras metálicas superpuestas y encajadas una sobre otra. Sobre estas estructuras se colocan los estantes y unas traseras deslizantes intercambiables.

Shelving unit. Five metal frames, one fitted on top of the other. The shelves and the sliding back interchangeable panels are laid over the frame.

ACABADOS: Estructura metálica y estantes, en acabado laca micro-texturada. Traseras, en acabado madera o laca micro-texturada.

FINISHES: Metal frame and shelves in micro-texturized lacquer. Back unit in wood finish or micro-texturized lacquer.



BIS

José Martínez-Medina



BIS

José Martínez-Medina





BS.150.P

90X44 h 150 cm / 35X17 h 59 in

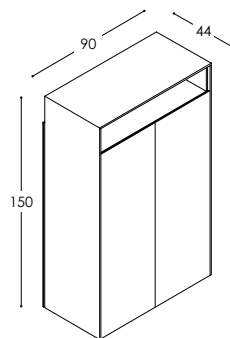

Contenedor vertical. Compuesto por 2 puertas y hueco diáfano superior. Equipado con freno en bisagras para cierre amortiguado silencioso (sin golpe). Deslizantes inferiores nivelables.

Vertical container. Two-door and top open space. Equipped with stop on hinges and automatic silent closure. Height adjustable glides.

ACABADOS: Envolvente y trasera, en acabado laca micro-texturada. Puertas, en acabado laca BRILLO. Tapa intermedia y estantes interiores, en acabado madera.

FINISHES: Unit and back board in micro-texturized lacquer finish. Doors in gloss lacquer finish. Intermediate top and bottom shelves in wood finish.

BS.205

90X44 h 200 cm / 35X17 h 79 in

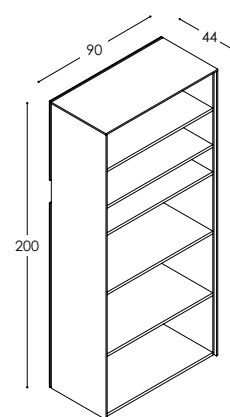

Contenedor vertical diáfano. Compuesto por estantes regulables en altura y hueco diáfano intermedio. Deslizantes inferiores nivelables.

Vertical container without doors. Open space equipped with height adjustable shelving. Height adjustable glides.

ACABADOS: Envolvente y trasera, en acabado laca micro-texturada. Tapa intermedia y estantes interiores, en acabado madera.

FINISHES: Unit and back board in micro-texturized lacquer finish. Intermediate top and bottom shelves in wood finish.

BS.150

90X44 h 150 cm / 35X17 h 59 in

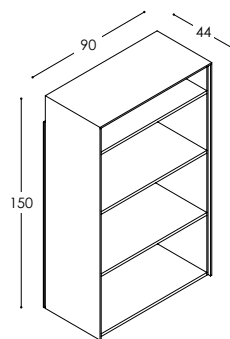

Contenedor vertical diáfano. Compuesto por estantes regulables en altura y hueco diáfano superior. Deslizantes inferiores nivelables.

Vertical container without doors. Open space equipped with height adjustable shelving. Height adjustable glides.

ACABADOS: Envolvente y trasera, en acabado laca micro-texturada. Tapa intermedia y estantes interiores, en acabado madera.

FINISHES: Unit and back board in micro-texturized lacquer finish. Intermediate top and bottom shelves in wood finish.

BS.205.P

90X44 h 200 cm / 35X17 h 79 in

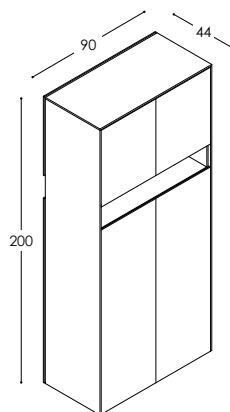

Contenedor vertical. Compuesto por 4 puertas y hueco diáfano intermedio. Equipado con freno en bisagras para cierre amortiguado silencioso (sin golpe). Deslizantes inferiores nivelables.

Vertical container. Four-door and top open space. Equipped with stop on hinges and automatic silent closure. Height adjustable glides.

ACABADOS: Envolvente y trasera, en acabado laca micro-texturada. Puertas, en acabado laca BRILLO. Tapa intermedia y estantes interiores, en acabado madera.

FINISHES: Unit and back board in micro-texturized lacquer finish. Doors in gloss lacquer finish. Intermediate top and bottom shelves in wood finish.

CULTURE BOX

José Martínez-Medina



CULTURE BOX

José Martínez-Medina



CB2.100

100X27 h 178 cm / 39X11 h 70 in

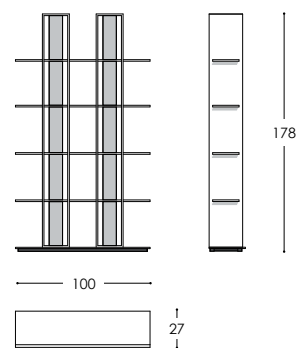

Contenedor / estantería vertical. Compuesta por 2 BOX o módulos, montados sobre tarima inferior y atravesados por los estantes horizontales.

Container vertical/shelving. Vertical container elements: two BOX/units fixed to a base support are crossed through by the shelves.

ACABADOS: Módulos BOX y tarima, en acabado laca micro-texturada. Traseras y estantes, en acabado madera.

FINISHES: BOX units and base support in micro-texturized lacquer finish. Back boards and shelves in wood finish.

CB3.140

140X27 h 178 cm / 55X11 h 70 in

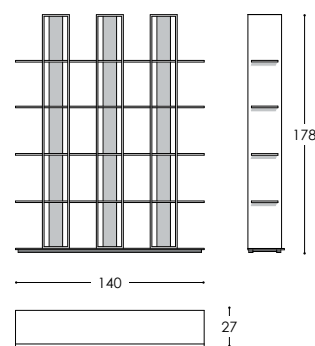

Contenedor / estantería vertical. Compuesta por 3 BOX o módulos, montados sobre tarima inferior y atravesados por los estantes horizontales.

Container vertical/shelving. Vertical container elements: three BOX/units fixed to a base support are crossed through by the shelves.

ACABADOS: Módulos BOX y tarima, en acabado laca micro-texturada. Traseras y estantes, en acabado madera.

FINISHES: BOX units and base support in micro-texturized lacquer finish. Back boards and shelves in wood finish.

CB4.180

180X27 h 178 cm / 71X11 h 70 in

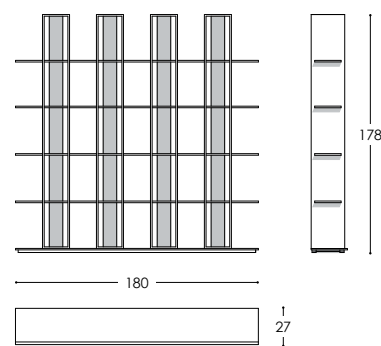

Contenedor / estantería vertical. Compuesta por 4 BOX o módulos, montados sobre tarima inferior y atravesados por los estantes horizontales.

Container vertical/shelving. Vertical container elements: four BOX/units fixed to a base support are crossed through by the shelves.

ACABADOS: Módulos BOX y tarima, en acabado laca micro-texturada. Traseras y estantes, en acabado madera.

FINISHES: BOX units and base support in micro-texturized lacquer finish. Back boards and shelves in wood finish.

OFICINA EN CASA / HOME OFFICE

UNIPERS

José Martínez-Medina



UNP.TOP

120x56 h 80 cm / 47X22 h 31 in

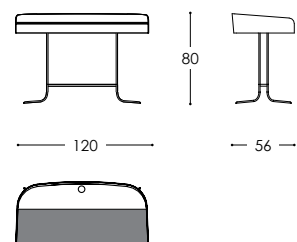

Mesa polivalente. Tapa lacada, con tablero elevado en laterales y parte posterior. Sobre tapa tapizada en zona de trabajo. Equipada con 2 bandejas/plumier a ambos lados, dejando libre la zona central. Base metálica realizada en perfil cilíndrico macizo. Traba inferior combinando perfil metálico y madera.

Multi-purpose table. Lacquered top, with raised screen on back and sideboards. Upholstered surface on working area. Equipped with 2 pencil trays on both sides of the table, leaving the central area clear. Cylindrical solid extruded metal frame and legs. The structural bar combines solid wood and metal.

ACABADOS:Tapa, en acabado lacado micro-texturado. Sobre tapa, tapizada en Piel-Tech. Fronteras y traba inferior, en acabado madera o laca micro-texturada. Estructura metálica, LACADA o en acabado Cromo Brillo.

FINISHES: Micro-texturized lacquer finish top. Upholstered working top in Piel-Tech. Drawer fronts and structural bar in wood or micro-texturized lacquer finish. Lacquer or Chrome gloss finish metal frame.

HO CUBE

José Martínez-Medina



HO CUBE

José Martínez-Medina



HO CUBE | TÉCNICO

HO.75

100x70 h 75 cm / 39X27 h 29 in

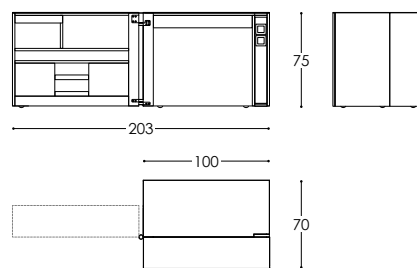

HOME OFFICE. Pequeño escritorio de trabajo equipado con estantes, cajones y archivo. Dispone además de electrificación e iluminación con LEDs. El ala del escritorio se abate 90° de manera que puede adoptar varias posiciones hasta quedar completamente cerrado ocultando su interior y ocupando el mínimo espacio. Sobre tapa superior tapizada en Piel-Tech.

HOME OFFICE. Small work desk equipped with shelves, drawers and filing cabinet. It also includes built-in electrification and LED lighting. The desktop extension may be folded at 90° in various positions until completely closed, concealing its interior and occupying minimum space.

ACABADOS: Envolvente, en acabado laca BRILLO. Interior, en acabado laca MATE. Sobre tapas, tapizadas en Piel-Tech. Bisagras, en Níquel negro.

FINISHES: Top, sides, door and back in micro-texturized lacquer gloss finish. Interior in lacquer matt finish. Overtop on trays upholstered in Tech-Leather. Hinges in Nickel.



OK CUBE

José Martínez-Medina



OK CUBE

José Martínez-Medina



OK.150

70x77 h 150 cm / 27X30 h 59 in

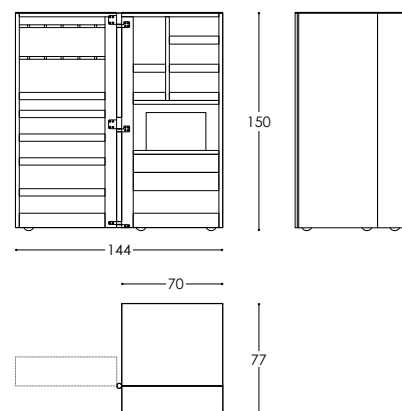

Office Kitchen. Mueble bar que alberga todo lo necesario para servir una bebida caliente o fría. Se compone de cajones con sistema Push, bandejas con retenida y cierre silencioso. La puerta va equipada con estantes para colocar botellas, vasos y copas. Sobre tapa superior tapizada. Posibilidad de electrificar para integrar electrodomésticos como una máquina Nespresso o frigo/botellero. (Electrodomésticos NO INCLUIDOS). Incorpora LEDs de efecto en la puerta.

Office kitchen. Bar cabinet that conceals everything necessary to serve a cold or hot beverage. It includes drawers with Push opening system and retention silentclosing trays. The door has shelves to put bottles, glasses and cups. Possible to electrify in order to integrate kitchen appliances such as a Nespresso machine or fridge (appliances NOT INCLUDED). Includes led lighting.

ACABADOS: Envoltente, en acabado laca BRILLO. Interior, en acabado laca MATE. Frente de estantes y cajones, en acero inox color. Sobre tapas, tapizadas en Piel-Tech. Bisagras, en Níquel negro.

FINISHES: Top, sides, door and back in micro-texturized lacquer gloss finish. Interior in lacquer matt finish. Fronts of shelves and drawers in color stainless steel. Overtop on trays upholstered in Tech-Leather. Hinges in black Nickel.

BACKSTAGE

José Martínez-Medina



BACKSTAGE - S

José Martínez-Medina



BACKSTAGE - S

José Martínez-Medina



BACKSTAGE | TÉCNICO

BCK-S.500

500x93 h 218 cm / 197X37 h 86 in

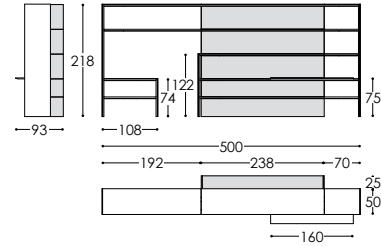

Estantería complementaria para mesa SWAN. Estantes formados por perfil de aluminio extrusionado. Estante inferior forrado en Acero Inox. con mecanismo eléctrico motorizado integrado.

[2 Schukos + 2 USB de Carga + 2 RJ45] CABLEADO INTERNO, NO INCLUIDO.

Complementary shelving for Swan table. Shelves formed by extruded aluminum profile. Interior shelf lined with stainless steel, includes integrated motorized electric mechanism.

(2 Schukos + 2 USB charging + 2 RJ45) INTERNAL WIRING, NOT INCLUDED.

ACABADOS: Costados y estantes en acabado laca micro-texturada. Estante inferior en acabado ACERO INOX.

FINISHES: Sides and shelves in micro-textured lacquer finish. Lower shelf in STAINLESS STEEL finish.

BCK-S.250

250x50 h 110 cm / 98X20 h 43 in

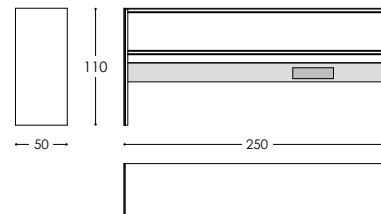

Estantería complementaria para mesa SWAN. Estantes formados por perfil de aluminio extrusionado. Estante inferior forrado en Acero Inox. con mecanismo eléctrico motorizado integrado.

[2 Schukos + 2 USB de Carga + 2 RJ45] CABLEADO INTERNO, NO INCLUIDO.

Complementary shelving for Swan table. Shelves formed by extruded aluminum profile. Interior shelf lined with stainless steel, includes integrated motorized electric mechanism.

(2 Schukos + 2 USB charging + 2 RJ45) INTERNAL WIRING, NOT INCLUDED.

ACABADOS: Costados y estantes en acabado laca micro-texturada. Estante inferior en acabado ACERO INOX.

FINISHES: Sides and shelves in micro-textured lacquer finish. Lower shelf in STAINLESS STEEL finish.

BCK-S.1C

100x45 h 33 cm / 39X18 h 13 in



Cajonera BACKSTAGE. Compuesta por 1 cajón de gran capacidad. Con ruedas ocultas.

Chest of drawers BACKSTAGE. Consisting of 1 large capacity drawer. With hidden wheels.

ACABADOS: Envolverte en acabado laca micro-texturada. Frente y trasera en acabado laca micro-texturada. Uñero superior en acabado ACERO INOX.

FINISHES: Surface in micro-textured lacquer finish. Front and back in micro-textured lacquer finish. Top handle in STAINLESS STEEL finish.

ACABADOS / FINISHES

LACAS / LACQUERS

Mate

Matt



Gris Concrete Mate
Grey Concrete Matt



Beige Capuccino Mate
Beige Capuccino Matt



Grey Ritz Matt
Grey Ritz Matt



Gris Emporio Mate
Grey Emporio Matt



Verde Harrods Mate
Green Harrods Matt



Verde Toscana Mate
Green Toscana Matt



Verde Olive Mate
Green Olive Matt



Verde Menta Mate
Green Mint Matt



Azul Flight Mate
Blue Flight Matt

LACAS / LACQUERS

Mate

Matt



Azul Summer Mate
Blue Summer Matt



Azul Sky Mate
Blue Sky Matt

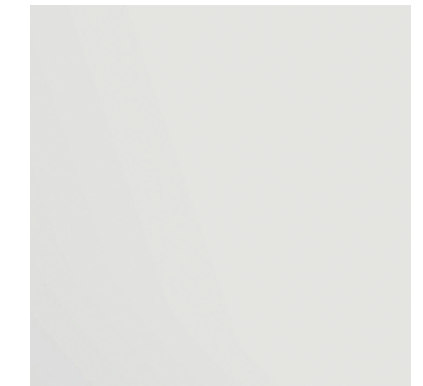

Azul Cloud Mate
Blue Cloud Matt



Amarillo Canary Mate
Yellow Canary Matt

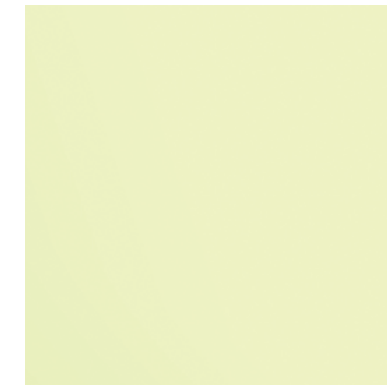

Amarillo Cream Mate
Yellow Cream Matt



Beige Stone Mate
Beige Stone Matt



Blanco Frost Mate
White Frost Matt



Rojo Calder Mate
Red Calder Matt



Naranja Hermes Mate
Orange Hermes Matt

LACAS / LACQUERS

Mate

Matt



Violeta Thai Mate
Purple Thai Matt



Violeta Skyline Mate
Purple Skyline Matt

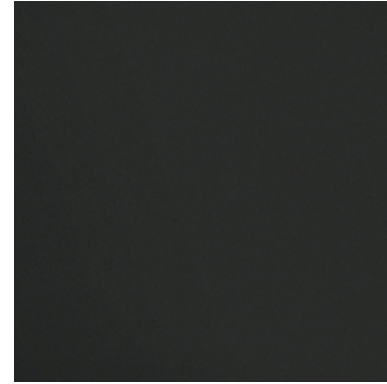

Grafito Mate
Graphite Matt



Tórtola Mate
Tortola Matt



Blanco Mate
White Dull Matt



Marrón Bugatti Mate
Brown Bugatti Matt



Negro Mate
Black Matt



Azul Noche Mate
Blue Night Matt



Marrón Caldera Mate
Brown Caldera Matt

LACAS / LACQUERS

Brillo

Gloss



Gris Concrete Brillo
Grey Concrete Gloss



Beige Capuccino Brillo
Beige Capuccino Gloss



Grey Ritz Brillo
Grey Ritz Gloss



Gris Emporio Brillo
Grey Emporio Gloss



Verde Harrods Brillo
Green Harrods Gloss



Verde Toscana Brillo
Green Toscana Gloss



Verde Olive Brillo
Green Olive Gloss



Verde Menta Brillo
Green Mint Gloss



Azul Flight Brillo
Blue Flight Gloss

LACAS / LACQUERS

Brillo

Gloss



Azul Summer Brillo
Blue Summer Gloss



Azul Sky Brillo
Blue Sky Gloss



Azul Cloud Brillo
Blue Cloud Gloss



Amarillo Canary Brillo
Yellow Canary Gloss



Amarillo Cream Brillo
Yellow Cream Gloss



Beige Stone Brillo
Beige Stone Gloss



Blanco Frost Brillo
White Frost Gloss



Rojo Calder Brillo
Red Calder Gloss



Naranja Hermes Brillo
Orange Hermes Gloss

LACAS / LACQUERS

Brillo

Gloss



Violeta Thai Brillo
Purple Thai Gloss



Violeta Skyline Brillo
Purple Skyline Gloss



Grafito Metalizado Brillo
Graphite Metallized Gloss



Tórtola Metalizado Brillo
Tortola Metallized Gloss



Blanco Metalizado Brillo
White Metallized Gloss



Marrón Bugatti Brillo
Brown Bugatti Gloss



Negro Brillo
Black Gloss



Azul Noche Brillo
Blue Night Gloss

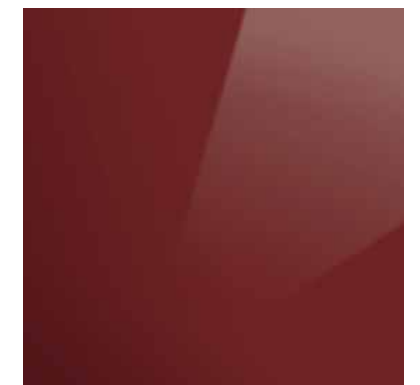

Marrón Caldera Brillo
Brown Caldera Gloss

MADERA



Roble Claro
Light Oak



Roble Medio
Medium Oak



Roble Oscuro
Dark Oak



Roble British
British Oak



Roble Fume
Fume Oak



Roble Tabaco
Tobacco Oak

MADERA PREMIUM



Ébano Macassar
Macassar Ebony



Nogal Eco-3
Walnut Eco-3



Nogal Americano
American Walnut

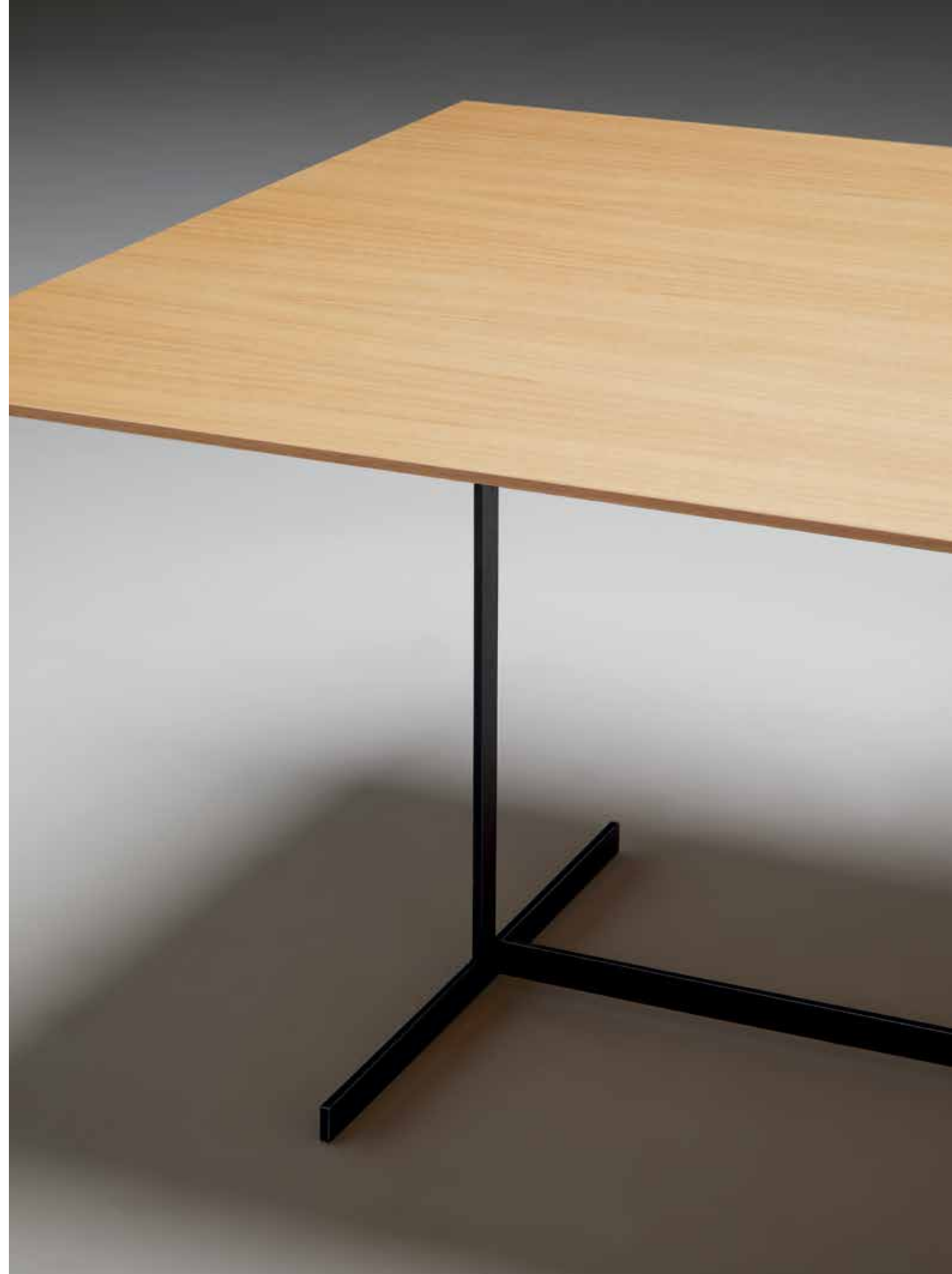

EDICIÓN ABRIL 2019
APRIL 2019 EDITION

Design & page layout
PYSKUNOV

Jmm
jose martinez-medina
www.jmm.es

JOSÉ MARTÍNEZ MEDINA S.A

T +34 96 127 01 62
jmm@jmm.es
export@jmm.es

JMM AMERICA LLC

2750 NW 84th Ave
Doral, FL 33122

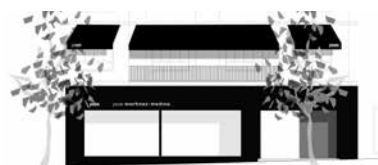

Showroom
Cea Bermudez, 56 Madrid



JMM Factory
Camino del Bony, S/N
Pol. Ind. Catarroja
Valencia



José Martínez-Medina



jmm
jose martinez-medina

www.jmm.es