



# **BLACK TONE**

by José  
Martínez  
Medina

**BLACK  
TONE** by José  
Martínez  
Medina



This is  
**BLACK  
TONE**

José Martínez Medina (JMM) es una marca de autor especializada en la producción de espacios de trabajo y reunión. Su nueva marca Black Tone surge para ampliar la gama de producto y dar cabida a otros diseñadores. Con 125 años de historia y estas nuevas colaboraciones, JMM ha encontrado un camino donde convergen ambas marcas, dialogando entre sí y creando espacios donde apetece trabajar.

José Martínez Medina (JMM) is a signature brand that has specialised in the production of work and meeting spaces. The newly created Black Tone brand has broadened the firm's product range and has wisely accommodated the talent of other collaborating designers. With 125 years of history, and now with the consolidation of these new collaborations, JMM has found a path where both brands converge, where dialogue between the two is serenely established; the result is new spaces where we are all more than happy to work in.

# INDEX

## Armchairs



Paola **NEW**  
12-19



Lys **NEW FINISHES**  
20-29



Kong  
30-41



Neo  
42-51

## Chairs



French **NEW**  
54-63



Copenhagen  
64-71

## Stools

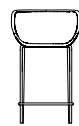

Punch  
74-81



Tap  
82-87

## Sofas

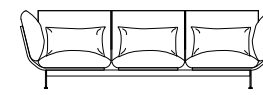

Babouche **NEW**  
90-99

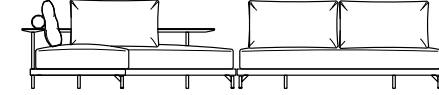

Alexander **NEW**  
100-109

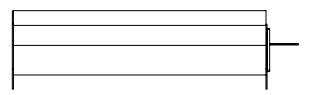

Joseph **NEW FINISHES**  
112-127

## Tables

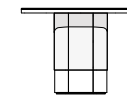

Chrysler Skyline **NEW**  
130-133

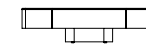

Chrysler **NEW FINISHES**  
134-141



Té  
142-147

## Accessories

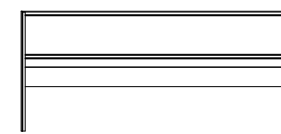

Backstage **NEW**  
150-157

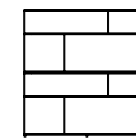

Cota **NEW FINISHES**  
158-167

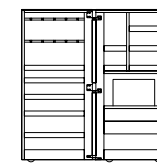

OK cube  
168-173

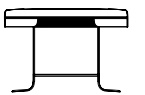

Unipers  
176-181

## DESIGNERS

### José Martínez-Medina

---

Arquitecto técnico, diseñador y fabricante de muebles.

"El diseño de muebles es una de las maneras más gratificantes de ser humano".

Technical Architect, designer, furniture manufacturer.

"The furniture design is one of the most rewarding ways of being human".

### Carlos Tíscar

---

Estudió Diseño Industrial en la Escuela de Artes Aplicadas de València (1982) y en la Scuola Politécnica di Design de Milán. Fue miembro del grupo Factoría Diseño Industrial (1987) y socio de Gesto Design Management (1991). Desde 1993 dirige su propio estudio. Ha impartido la asignatura de proyectos para las siguientes escuelas e instituciones: Barreira (Valencia), AIMME (Paterna), Eset CEU (Alfara del Patriarca) y EASD (Valencia). Su trabajo ha merecido, entre otros, el Premio ADCV Oro, el Premio ADCV Oro, el Good Design Award, el German Design Award, y el iF Design Award.

He study Industrial at the School of Applied Arts of València (1982) and at the Scuola Politécnica di Design in Milan. He was a member of the Industrial Design Factory (1987) and as a partner of Gesto Design Management (1991). Since 1993 he has directed his own studio. He has taught the subject of projects for the following schools and institutions: Barreira (Valencia), AIMME (Paterna), Eset CEU (Alfara del Patriarca) and EASD (Valencia). His work has deserved, among others, the Impiva Award, the ADCV Gold Award, the Good Design Award, the German Design Award, and the iF Design Award.

### Francesc Rifé

---

Fundó su estudio en Barcelona en 1994 y articula toda su obra en torno al orden espacial y a la proporción geométrica, con una atención especial a los materiales nobles. Ha recibido numerosos galardones de diseño como son el Contract World Awards, el Red Dot, el Premio Nacional de Arquitectura Efímera, Emporia, ICFE Editors Awards, Premios FAD y varios premios ASCER.

He founded his studio in Barcelona in 1994, and his work is centred on the issues of spatial order and geometric proportions, with special attention to noble materials. He has received numerous design awards such as the Contract World Awards, the Red Dot Award, the National Ephemeral Architecture Award, the Emporia Award, the ICFE Editors Award, the FAD Award and several ASCER awards.

### Eli Gutiérrez

---

Diseñadora cosmopolita nacida en Valencia (España). Ha vivido en Londres, Milán y París donde ha colaborado con estudios mundialmente conocidos de diseño e interiorismo. A finales de 2015 abre su estudio propio. Su enfoque cosmopolita se puede definir como un "ciudadano del mundo", una exploradora atenta a los detalles, un viajero con una mirada contemporánea e incisiva remodelando los códigos tradicionales de nuestro entorno con una elegancia elocuente y fresca.

Cosmopolitan designer born in Valencia (Spain). She has been living in London, Milan and Paris where she has collaborated with some of the most well know design studios before opening her own in 2015. Her cosmopolitan approach can be defined as a "World Citizen", an explorer attentive to detail. A traveler with a contemporary and incisive look remodeling the traditional codes of our environment with an eloquent and fresh elegance.





ARMCHAIRS

**NEW****PAOLA**

Francesc Rifé

La nueva butaca Paola es una declaración de simplicidad. Un diseño reducido a lo esencial en el que el cuerpo, confeccionado en piel, viste parcialmente el asiento y el respaldo bajo la dirección de una estructura de acero tubular. Trazando un trapecio, las patas integran el detalle del reposabrazos tapizado, mientras la estabilidad de la pieza reside en la tensión precisa del cuero. Se trata de una estructura liviana y sin distracciones, disponible en una gran variedad de acabados y colores.

The new armchair Paola is a statement of simplicity. A design reduced to the essentials in which the body, made of leather, partially dresses the back and seat under the direction of a tubular steel structure. Tracing a trapeze, the legs integrate the detail of the upholstered armrest, while the stability of the piece lies in the tension provided of the leather. It is a lightweight structure, available in a wide variety of finishes.







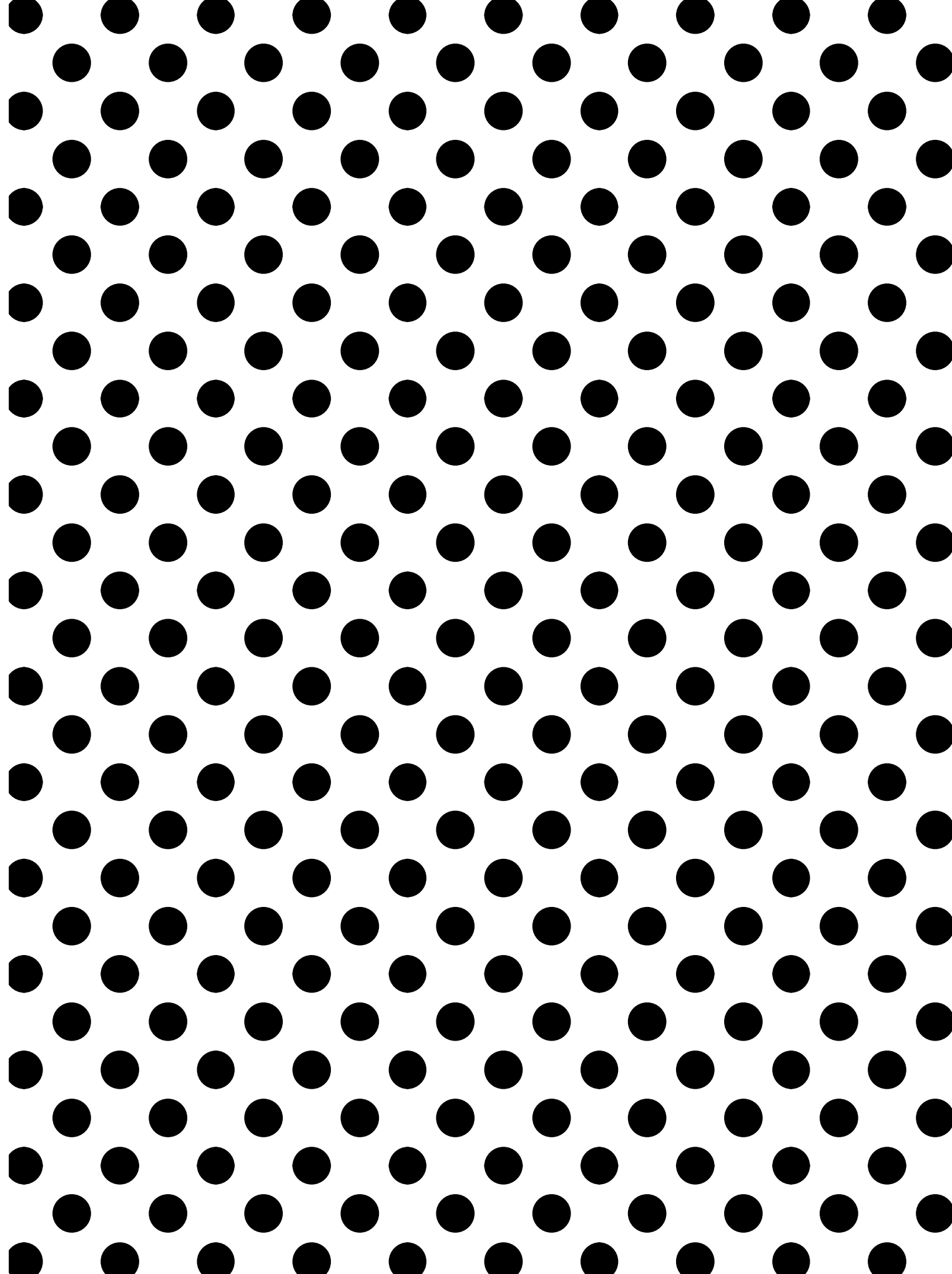



## TECHNICAL DETAILS

Fabricada en cuero natural, cosido a mano artesanalmente. Estructura de acero tubular. Detalle tapizado en la zona de los reposabrazos.

Made of natural leather, hand-stitched by hand. Tubular steel structure. Upholstered detail in the armrest area.

## FINISHES

Estructura metálica: lacada en negro mate.  
Tapizado: cuero natural.

Metal structure in black matt laquer finish.  
Upholstery: natural leather.

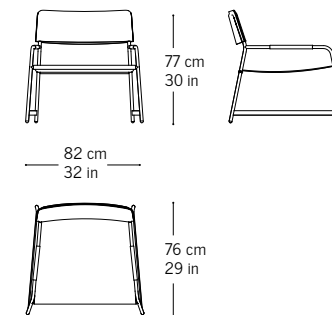

82x76 h 77 cm / 32x29 h 30 in

## NEW FINISHES

### LYS

José Martínez-Medina

---

Butaca cosida a mano en cuero natural con reposabrazos en madera maciza de roble o nogal americano. Ideal para equipar zonas de *living* o de *lounge*. Es una pieza desmontable en la que no se aprecian los elementos de fijación. Una pieza de gran solidez que a su vez fluye y acoge por su notable amplitud.

Hand-stitched armchair in natural leather with armrests in solid oak wood or american walnut wood. Ideal to equip living or lounge areas. It is a removable part in which the fixing elements are not appreciated. Here is a piece of great solidity that at the same time flows and embraces for its notable amplitude.





Feria Hábitat Valencia Stand







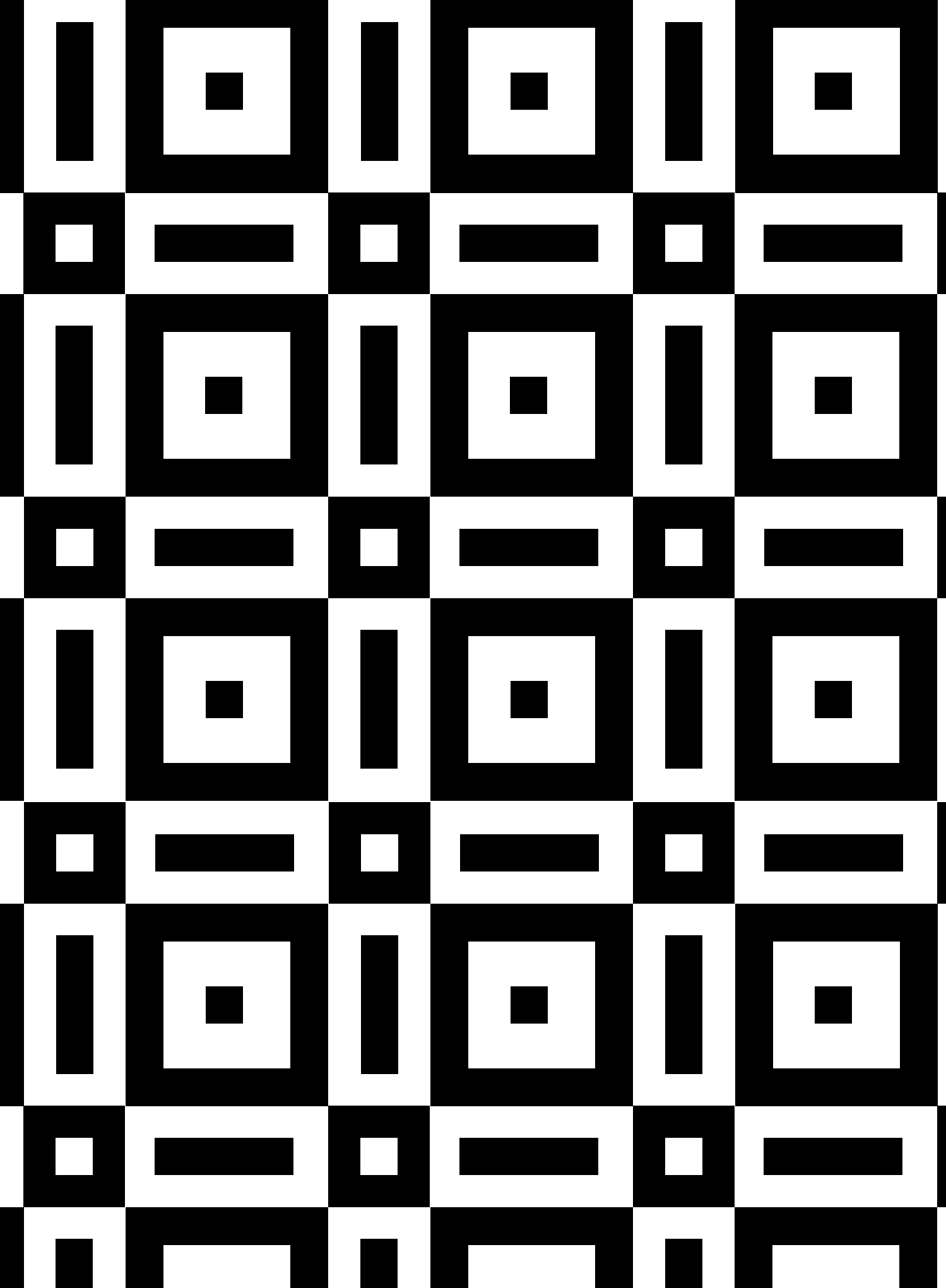

#### TECHNICAL DETAILS

Fabricada en cuero natural, cosido a mano artesanalmente. Reposabrazos y armazón estructural en madera de roble o nogal americano. Totalmente desmontable con elementos de fijación ocultos.

Made of natural leather, hand-stitched by hand. Armrests and structural frame in oak wood or American walnut wood. Can be fully dismantled with hidden fasteners.

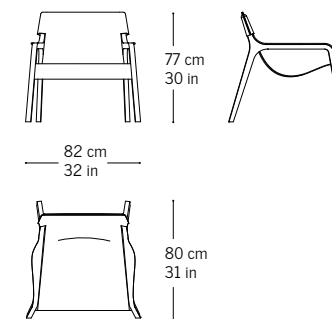

#### FINISHES

82x80 h 77 cm / 32x31 h 30 in

Brazos, en madera de roble o nogal americano.  
Tapizado: cuero natural.

Armrests in oak wood or American walnut wood.  
Upholstery: natural leather.

## KONG

Francesc Rifé

---

Colección de butacas de diferentes anchos, sofá, sofá componible y puff, realizados con gomas de diferentes densidades y un esqueleto interno en madera. La estructura vista que rodea cada pieza define la fuerte personalidad de un diseño de gran confort, en el que los brazos ayudan mucho para la acción de levantarse. Es una colección perfecta para áreas de bienvenida y espacios VIP en la que las butacas ayudan a cerrar el conjunto living.

This collection of seats comes with different widths; there is a sofa, an adaptable sofa and a pouffe, all made from rubber fillings with varying densities and an inner timber frame. The visible structure that envelopes each piece defines the strong personality of the design that confers great comfort to the user. The armrests greatly assist the function of getting up. This is the perfect collection for reception and welcoming areas, as well as for VIP spaces; the seats give a well-rounded complement to the living room ambience.















#### TECHNICAL DETAILS

Realizada con pletina de acero calibrada lacada en negro y tapizada con diferentes capas poliuretano de gran confort. Tapizada en piel técnica, piel natural o tela.

Made with calibrated steel plate lacquered in black and covered using different layers of polyurethane. Upholstered in tech-leather, natural leather or fabric.

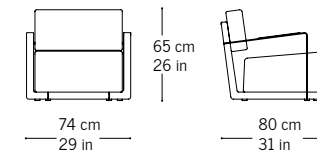

74x80 h 65 cm / 29x31 h 26 in

#### FINISHES

Estructura metálica: lacada en negro mate  
Tapizado: piel-tech, piel natural o tela.

Metal structure in black matt laquer finish.  
Upholstery: tech-leather, natural leather or fabric.

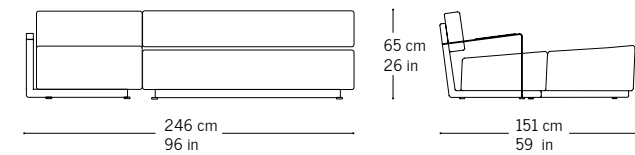

246x151 h 65 cm / 96x59 h 26 in

## NEO

Francesc Rifé

---

Con un claro carácter técnico que contrasta con la amabilidad de sus volúmenes, en la butaca y sofá Neo destaca el ejercicio de equilibrio vertical que combina un corpulento cuerpo con ligeras patas metálicas. Una colección majestuosa y contemporánea, particularmente adecuada para espacios de espera.

Its clear technical character contrasts with the inviting openness of its volumes. The Neo armchair and sofa are characterised by a vertically-inspired balance that combines a formidable main body with light metallic legs. The result is a majestic and contemporary collection that is well-suited to waiting areas.













#### TECHNICAL DETAILS

Bastidor interno de haya cinchado y recubierto con espuma de varias densidades para un mayor confort. Asiento, respaldo y brazos tapizados en piel tech, piel natural o tela. Estructura metálica lacada en negro mate.

Beech inner frame belted and covered with multi-density foams for greater comfort. Seat, backrest and armrest upholstered in tech-leather, natural leather or fabric. Metal frame lacquered in black matt.

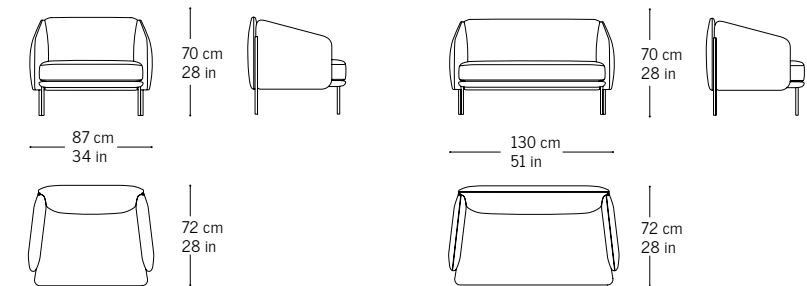

87x72 h 70 cm / 34x28 h 28 in

130x72 h 70 cm / 51x28 h 28 in

#### FINISHES

Estructura metálica, en acabado laca negro mate. Tapizado: piel-tech, piel natural o tela.

Metal structure in black matt laquer finish. Upholstery: tech-leather, natural leather or fabric.

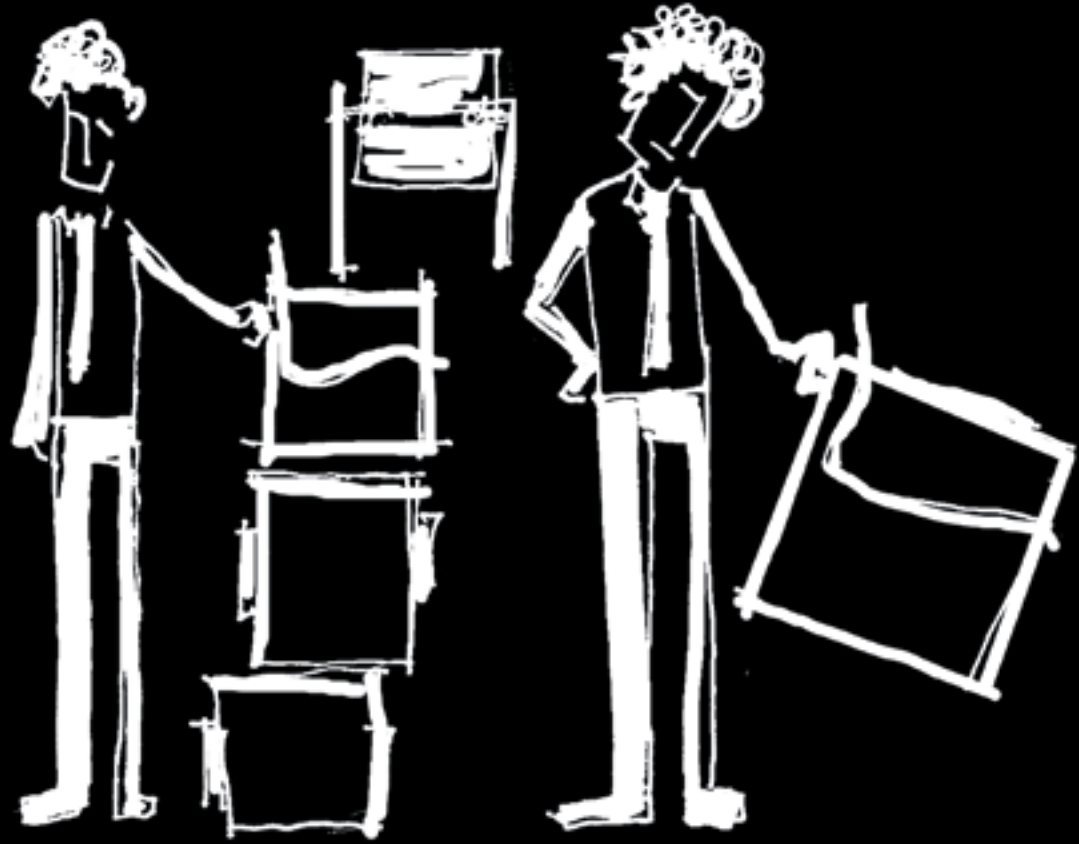

**CHAIRS**

**NEW****FRENCH**

Eli Gutiérrez

French está caracterizada por el contraste entre su asiento de formas contundentes y marcadas y la estructura mínima. Una forma arquitectónica contemporánea muy ergonómica, que abraza. Su característico asiento tapizado dividido en dos partes elegantemente completadas con costuras visibles ayudan a definir los volúmenes y las líneas de la silueta. El contraste entre el uso de piel en la parte interna y tejido en la parte externa hace que sea extremadamente confortable, además de brindar infinidad de combinaciones y acabados. Una pieza adecuada para cualquier uso y espacio, ya sea en *contract* o en el hogar.

French is characterized by the contrast between their bold aesthetic seat and the minimal structure. A contemporary architectural form almost in equilibrium, that gives an ergonomical feeling once you sit on it. Its main characteristic is the 2 upholstered shells that is always elegantly completed with visible stitching that defines the object volumes and edges. The contrast between leather in the inside and fabric in the outside makes the seat embracing and extremely comfortable, giving infinity possibilities of combinations and finishes suitable for any space such as *contract* or home.











#### TECHNICAL DETAILS

Asiento de carcasa curvada totalmente tapizada. Estructura metálica de tubo curvado. Disponible con base metálica con 5 espas y ruedas, regulable en altura mediante pistón de gas.

Curved-frame seat completely upholstered. Metal structure in curved tube. Available with five-stars metal base with castors, equipped with adjustable height pneumatic mechanism.

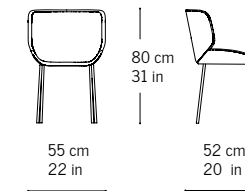

55x52 h 80 cm / 22x20 h 31 in

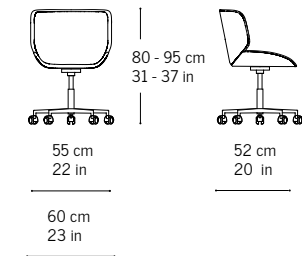

60x52 h 80-95 cm / 23x20 h 31-37 in

#### FINISHES

Tapizado en Piel-Tech, Tela o Piel natural.  
Estructura, lacada.  
Base metálica, en acabado cromo brillo.  
(Consultar precio, para otros acabados)

Uholstered in Tech-Leather, Fabric or Natural leather.  
Lacquered structure.  
Metal base, in glossy chrome finish.  
(Consult price, for other finishes)



## COPENHAGUE

José Martínez-Medina

---

Esta silla discreta y sensual para hogar, hospitality y contract es una pieza construida con un molde exclusivo en madera lacada sobre estructura con planta en cuña. Creada en exclusiva para BlackTone, resulta muy agradable acariciar sus brazos macizos de nogal. En su espalda dispone de asa en cuero auténtico realizado con una depurada técnica de confección.

This discrete yet sensual chair for home, hospitality and contract contexts is a piece based on an exclusive mould garnished with lacquered wood. The structure rests on an impressive wedge base. Created exclusively for BlackTone, it is very pleasant indeed to feel its solid walnut armrests. The backrest has a handsome, authentic leather handle inspired in a refined leatherwork technique.









#### TECHNICAL DETAILS

Silla fija.  
Con asiento y respaldo en tablero curvado sin tapizar. Base y brazos realizados en estructura metálica de tubo cuadrado. Detalle en brazos de madera de nogal y asa posterior en cuero.

Fix chair.  
Curved-wooden board seat and back without upholstery. Square tube metal structure on base and arms. Arms detail in walnut and back handle in leather.

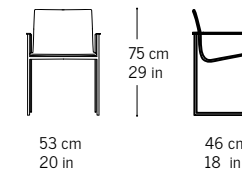

53x46 h 75 cm / 20x18 h 29 in

#### FINISHES

Estructura metálica, en acabado lacado negro.  
Respaldo y asiento, en acabado lacado.

Metal Structure, black matt lacquer finish.  
Back and seat, in matt lacquer finish.



**STOOLS**

## PUNCH

Eli Gutiérrez

Punch está caracterizada por el contraste entre su asiento de formas contundentes y marcadas y la estructura mínima. Una forma arquitectónica contemporánea muy ergonómica, que abraza. Su característico asiento tapizado dividido en dos partes elegantemente completadas con costuras visibles ayudan a definir los volúmenes y las líneas de la silueta. El contraste entre el uso de piel en la parte interna y tejido en la parte externa hace que sea extremadamente confortable, además de brindar infinidad de combinaciones y acabados. Una pieza adecuada para cualquier uso y espacio, ya sea en *contract* o en el hogar.

Punch is characterized by the contrast between their bold aesthetic seat and the minimal structure. A contemporary architectural form almost in equilibrium, that gives an ergonomical feeling once you sit on it. Its main characteristic is the 2 upholstered shells that is always elegantly completed with visible stitching that defines the object volumes and edges. The contrast between leather in the inside and fabric in the outside makes the seat embracing and extremely comfortable, giving infinity possibilities of combinations and finishes suitable for any space such as *contract* or home.



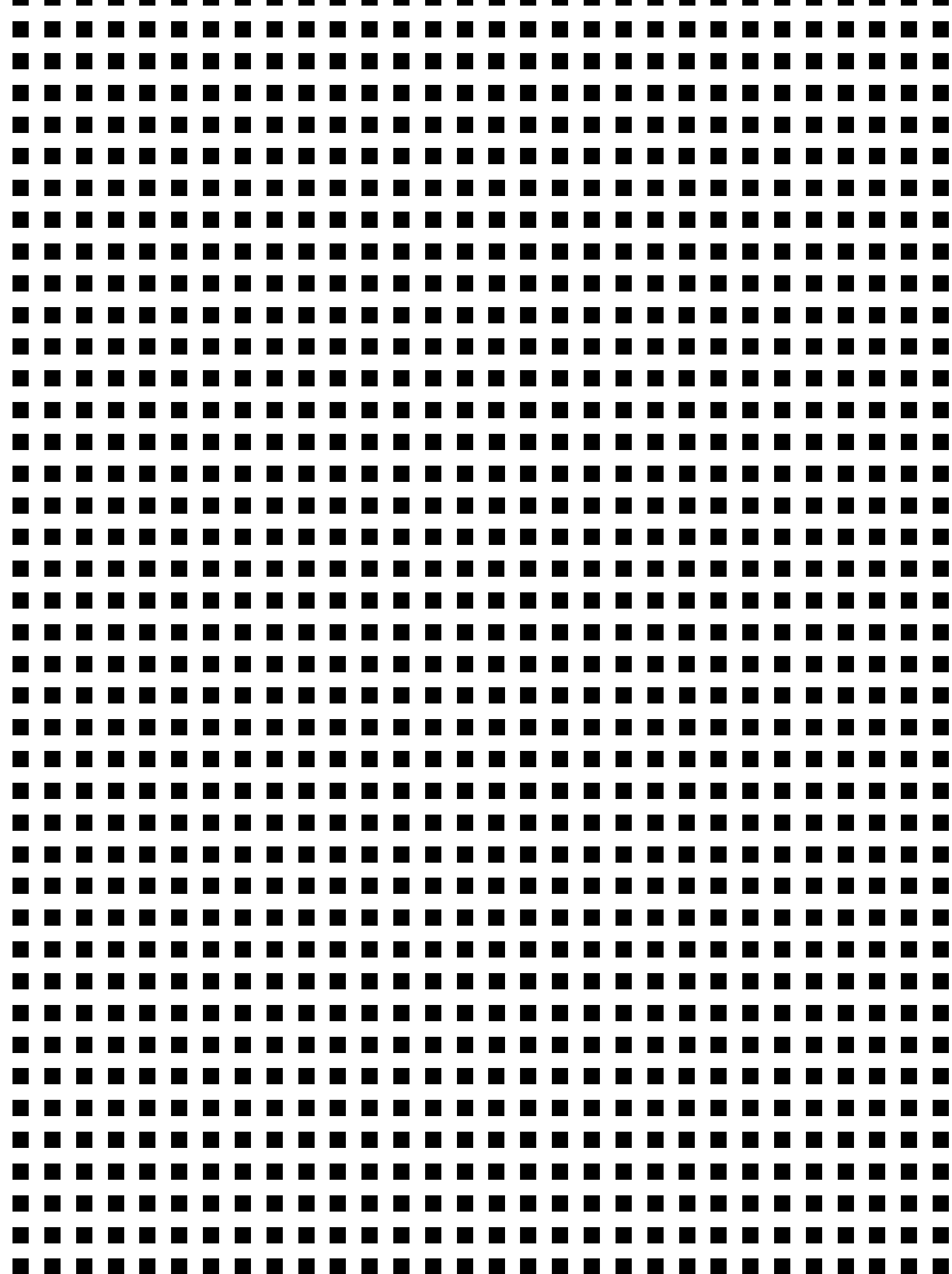







#### TECHNICAL DETAILS

Taburete de carcasa curvada totalmente tapizada.  
Estructura metálica de tubo curvado con asidero posterior para facilitar su movimiento.

Curved-frame stool completely upholstered.  
Metal structure in curved tube with back handle to facilitate moving.

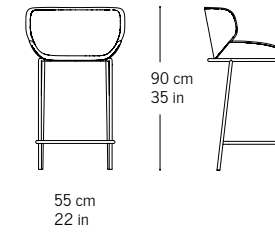

#### FINISHES

Tapizado en Piel-Tech, Tela o Piel natural.  
Estructura lacada.

Upholstered in Tech-Leather, Fabric or Natural leather.  
Lacquered structure.

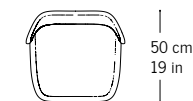

55x50 h 90 cm / 22x19 h 35 in

## TAP

Francesc Rifé

---

Con una simplicidad geométrica intrínsecamente relacionada a los diseños de Francesc Rifé, este taburete cilíndrico nace como asiento complementario cargado de practicidad. A un cuerpo acolchado se une el asa de piel que facilita su movilidad, además de contribuir a la personalidad estética de la pieza junto con elección de la altura y el color. Una ligera inclinación en la superficie del asiento proporciona el confort y estabilidad necesarios.

Characterised by a geometric simplicity that is intrinsic to the creations of Francesc Rifé, this cylindrical stool has been envisaged as a complementary seat imbued with utter practicality. A padded main structure, together with a leather handle facilitates its movement and the desired position; it also contributes to the aesthetic personality of the piece, thanks also to the height and colour choice. A slight inclination on the seat itself provides the necessary comfort and stability.





TAP



#### TECHNICAL DETAILS

Taburete de forma cilíndrica con ligera inclinación del asiento para darle mayor ergonomía. Dispone de un asa de cuero formada por 3 capas que permite desplazarlo con facilidad.

Cylindrical stool with slight inclination of the seat to provide better ergonomics. 3 layers leather handle to facilitate moving and handling.

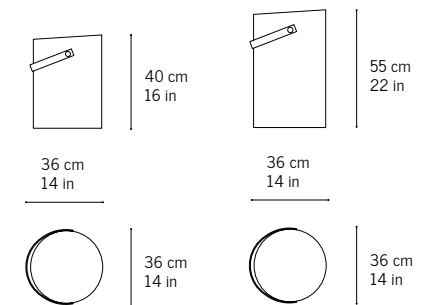

#### FINISHES

Tapizado en piel-tech o tela. Asa en cuero.

Upholstery in tech-leather or fabric. Leather handle.

Ø36 h 40 cm /  
Ø14 h 16 in

Ø36 h 55 cm /  
Ø14 h 22 in

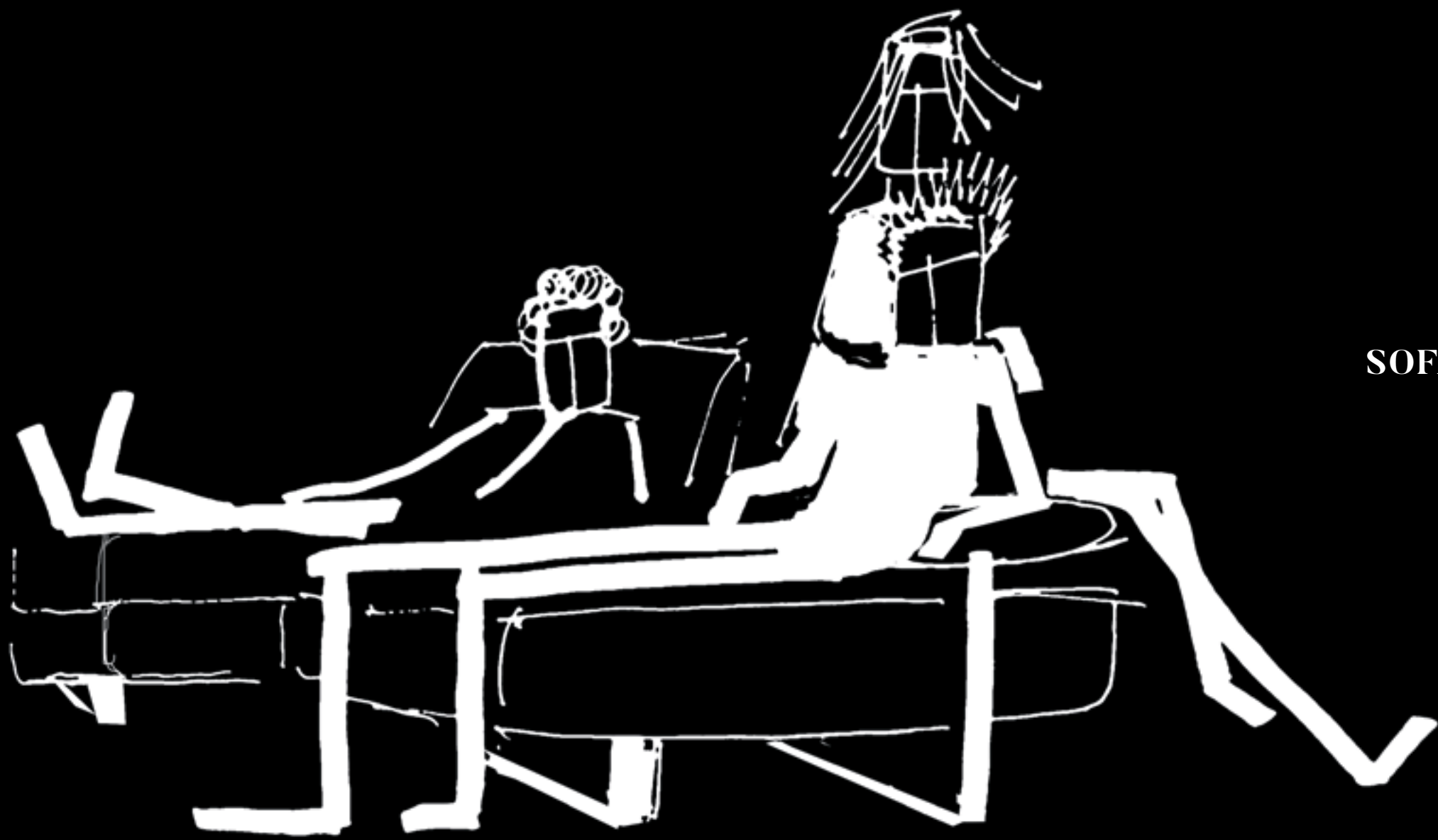

**SOFAS**

**NEW****BABOUCHE**

Carlos Tíscar

Cómodo, informal y distendido, el sofá Babouche es como el calzado del que toma su nombre. Grandes y confortables cojines unidos entre sí mediante cremalleras y soportados por estructuras de contrachapado curvado. Unas estructuras que están tapizadas y van unidas a una base con patas de pletina de acero pintado rematadas en conteras de nailon.

Comfortable, informal and relaxed, the Babouche sofa is like the footwear from which it takes its name. Large, comfortable cushions joined together by zippers and supported by curved plywood structures. These structures are upholstered and attached to a base with painted steel plate legs finished off with nylon ferrules.





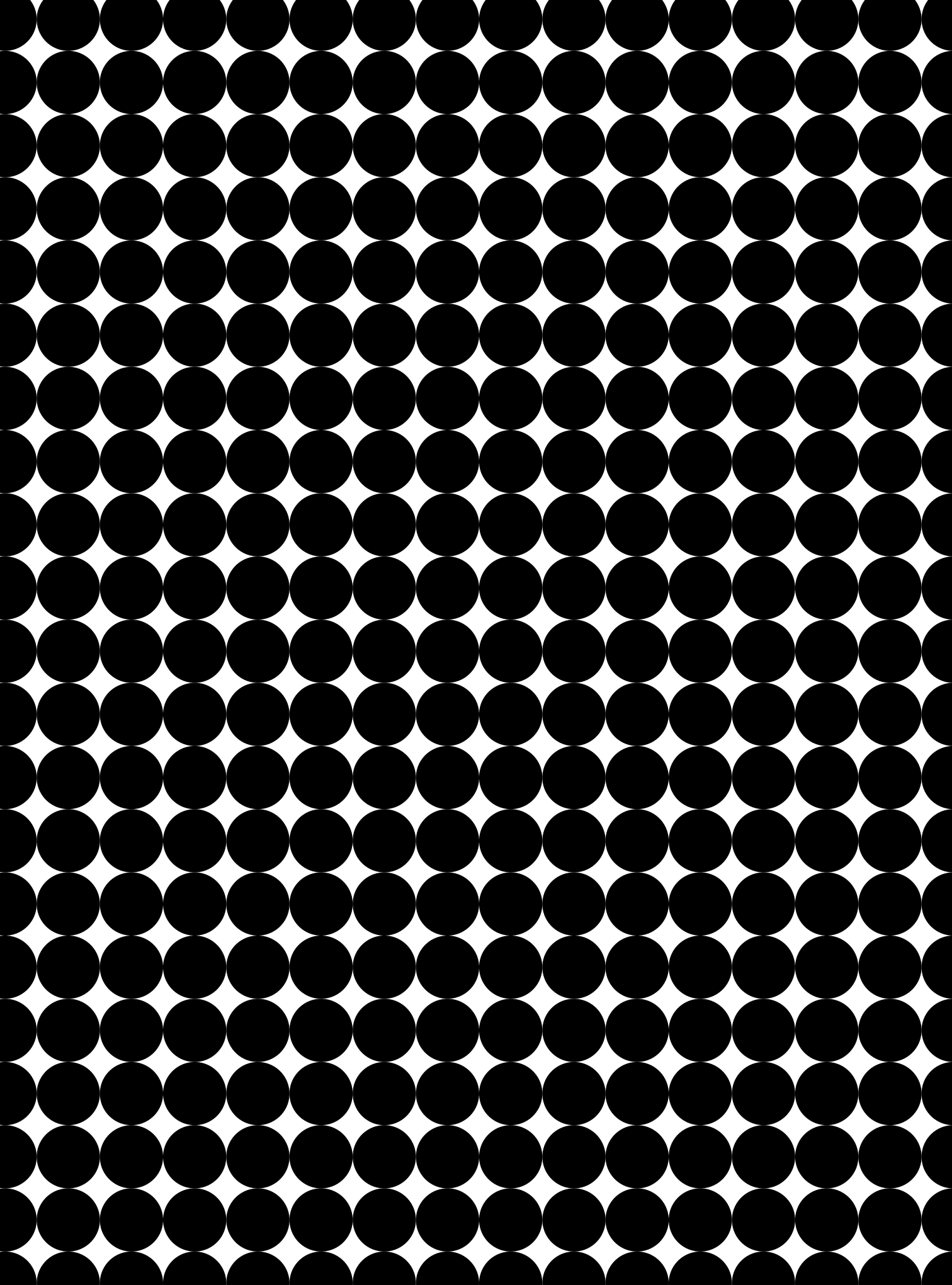







TECHNICAL DETAILS

Bastidor interno metálico y de tablero contrachapado totalmente tapizado. Asientos y respaldos formados por espumas ignífugas de última generación, combinando 2 densidades para asegurar un mayor confort. Incluye 1 cojín de pluma por plaza. Patas metálicas en acabado laca color negro mate.

Internal metal frame and fully upholstered plywood board. Seats and backrests made of the latest generation of fireproof foams, combining 2 densities to ensure greater comfort. It includes 1 feather cushion per seat. Metallic legs in matt black lacquer finish.

FINISHES

Patas metálicas lacadas en color negro mate. Estructura, asientos y respaldo tapizados en tela. Cojines de pluma tapizados en tela.

Metal legs in black matt laquer finish. Structure, seats and backrest upholstered in fabric. Feather cushions upholstered in fabric.

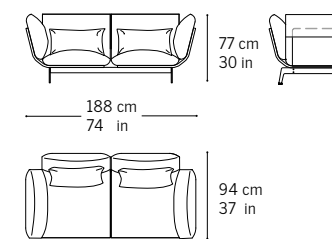

188x94 h 77 cm / 74x37 h 30 in

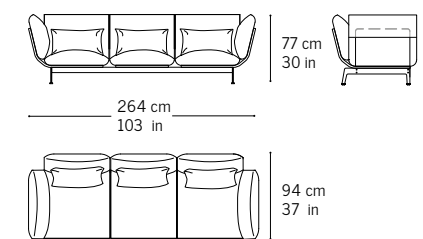

264x94 h 77 cm / 103x37 h 30 in

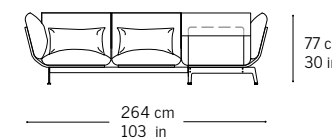

264x264 h 77 cm / 103x103 h 30 in

**NEW****ALEXANDER**

José Martínez-Medina

Alexander es la flexibilidad hecha sofá. Con un asiento corrido de una sola pieza, el respaldo articulado, los almohadones y las riñoneras son independientes, permitiéndonos diversas posiciones para un mayor confort. Un sofá totalmente desenfundable y desmontable que se adapta a tus necesidades.

El perímetro exterior del asiento en la zona de respaldo y brazo lleva diferentes bolsillos. Acompaña al conjunto una plaza destinada a mesa en madera maciza de roble con fondo en piel, cinco pequeñas tapas en laca brillo y mecanismo eléctrico.

Alexander is flexibility made into a sofa. With a continuous one piece seat, the articulated backrest, the cushions and lumbar pillows are independent, allowing various positions for greater comfort. A fully removable and detachable sofa that adapts to your needs. The outer perimeter of the seat in the back and armrest area has different pockets. The set is accompanied by a piece destined for a table in solid oak wood with a leather base, five small covers in gloss lacquer and an electric mechanism.











## TECHNICAL DETAILS

Composición de asientos. Estructura de acero tapizada donde se apoyan las repisas de los brazos y respaldos, tapizadas en cuero natural mediante elementos metálicos acabados en baño de oro negro. El asiento corrido, está realizado en una sola pieza con espuma poliuretánica de nueva generación y una capa superior de pluma. Los almohadones respaldo con mecanismo articulado independiente, están rellenos de pluma al 100%. El perímetro exterior del asiento en la zona de respaldo y brazo, lleva diferentes bolsillos para alojar revistas, Tablet, mando TV, etc. Totalmente desenfundable y desmontable. Complementa el conjunto una plaza destinada a mesa auxiliar, con divisiones y pequeñas tapas deslizantes, con 2 enchufes integrados.

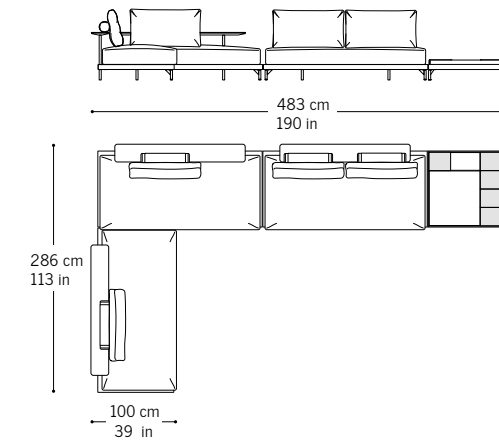

483x286 h 81 cm / 190x113 h 32 in

Upholstered steel structure on which the armrest and backrest shelves rest, upholstered in natural leather using metallic elements finished in black gold plating. The bench seat is made of a single piece of new generation polyurethane foam and a top layer of feather. The back cushions with independent articulated mechanism are filled with 100% feather. The outer perimeter of the seat in the backrest and armrest area has different pockets for magazines, tablets, TV remote control, etc. It is completely removable and detachable. The set is complemented by a place for auxiliary table with solid wood trays with divisions, inner bottom upholstered in Tech-Leather and small sliding covers in gloss finish, with 2 integrated plugs.

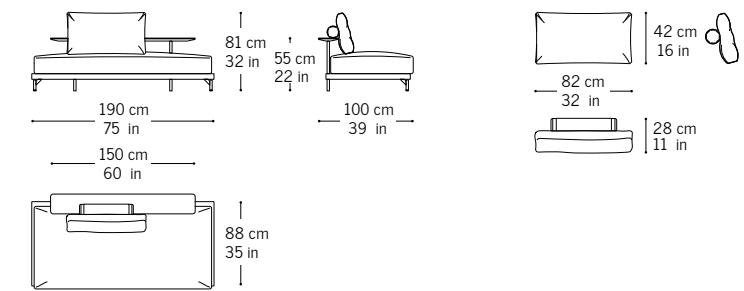

190x100 h 81 cm / 75x39 h 32 in

82x28 h 42 cm / 32x11 h 16 in

## FINISHES

Elementos metálicos; acabado en baño de oro negro. Bandejas y repisas; acabado laca y cuero natural. Elementos tapizados; en tela. Mesa auxiliar; en madera de roble, fondos tapizados en piel-tech, tapas en laca brillo.

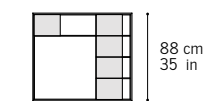
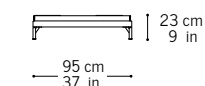

95x88 h 23 cm / 37x35 h 9 in

Metallic elements: black gold-plated finish. Trays and shelves: lacquered and natural leather finish. Upholstered elements: in fabric. Auxiliary table: in oak wood with tech-leather upholstered bottoms and gloss lacquered covers.





## NEW FINISHES

### JOSEPH

José Martínez-Medina

---

Un sofá extremadamente estructural y ligero que se aleja del entorno doméstico para proponernos una agradable conversación en confortables almohadones de respaldos anatómicos sueltos. Está elaborado con espumas poliuretánicas de gran calidad y alta densidad cuyas juntas, marcadas en el tapizado, refuerzan el diseño y ayudan a eliminar las arrugas. Estructura de pletina de acero en cromo negro brillo. Respaldo en madera o tapizado.

This is an extremely structural and light sofa that moves away from the domestic environment to propose us a pleasant conversation in comfortable cushions of loose anatomical backrests. Made with high quality and high density polyurethane foam. The recess marked in the upholstery reinforces the design and helps eliminate wrinkles. Steel plate structure in black chrome. Backrest in wood finish or upholstered.







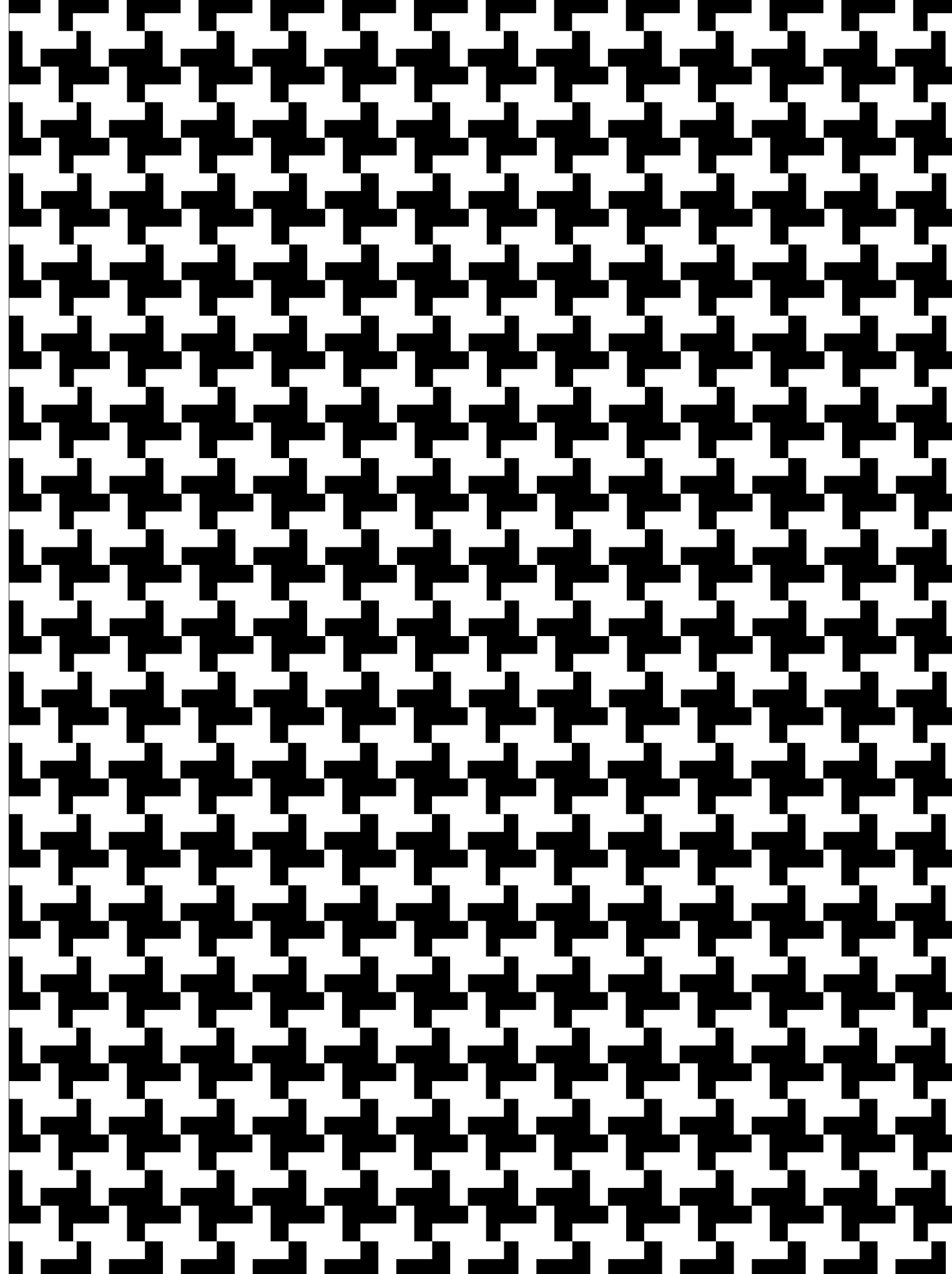









#### TECHNICAL DETAILS

No es un sofá doméstico, pero es cómodo y mantiene una postura correcta de conversación. Extremadamente estructural y ligero con almohadones de respaldo anatómicos y sueltos. Realizado con espumas de poliuretano de gran calidad y alta densidad. La junta marcada en el tapizado refuerza el diseño y ayuda a eliminar las arrugas. Estructura de corte láser en plancha metálica calibrada. Acabado en níquel negro. Respaldo en acabado madera.

It is not a residential sofa, but it is comfortable and provides the correct posture for conversation. Lightweight structure with individual anatomic back support. Made with high quality and high density polyurethane foam. The recess marked in the upholstery reinforces the design and helps eliminate wrinkles. Steel plate structure in black nickel, wood finish backrest.

#### FINISHES

Estructura metálica, níquel negro. Tapizado en piel-tech o tela. Respaldo y bandeja en acabado madera / tapizado.

Metal structure: black nickel. Upholstery: tech-leather or fabric. Backrest and tray in wood finish / upholstered.

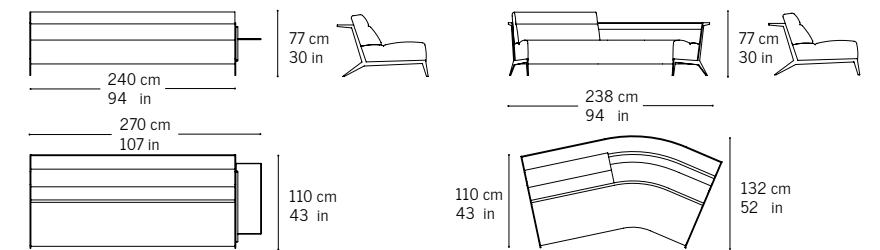

242x80 h 80 cm / 95x31 h 31 in

242x80 h 30 cm / 95x31 h 12 in

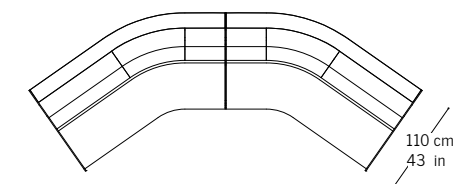
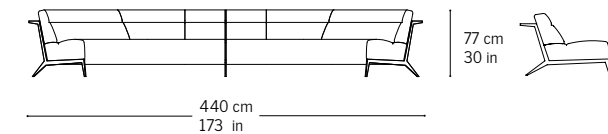

440x110 h 77 cm / 173x43 h 30 in

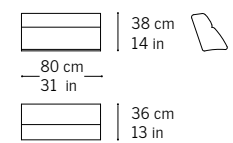

Backrest section  
80x36 h 38 cm / 31x13 h 14 in

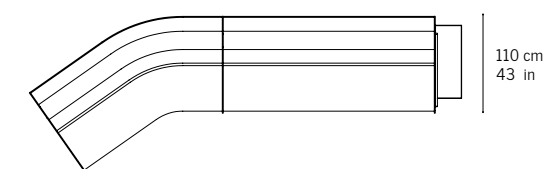
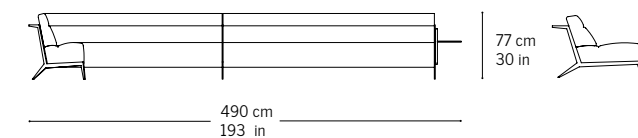

490x110 h 77 cm / 193x43 h 30 in



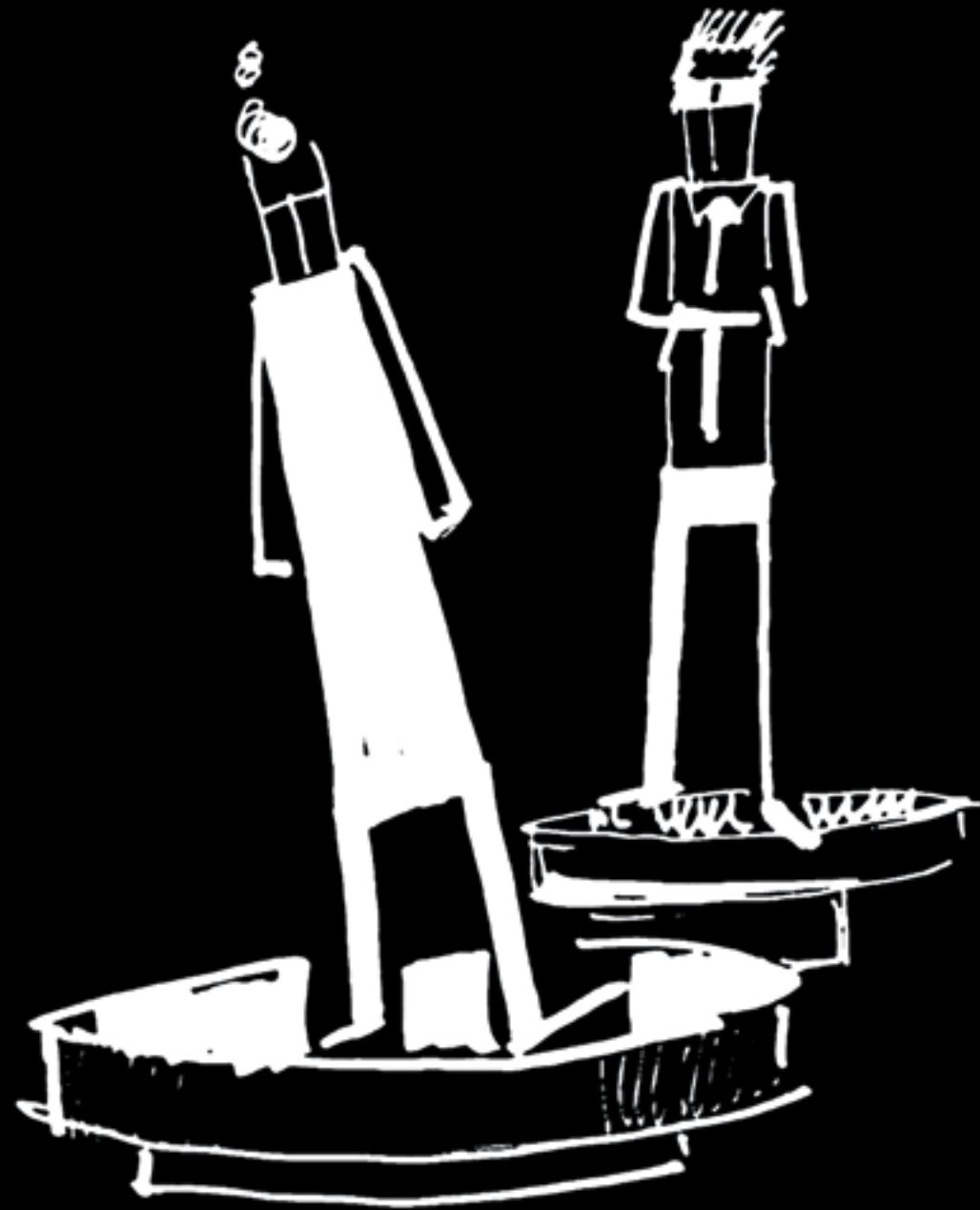

**TABLES**

**NEW****CHRYSLER SKYLINE**

José Martínez-Medina

Una combinación de materiales extraordinarios para una familia de mesas que no son redondas ni cuadradas, sino algo lobuladas y sobre todo majestuosas. La mesa Chrysler Skyline, con una altura de 72 cm, se presenta con la tapa en el nuevo porcelánico Mont Blanc (Neolith) con base de madera natural de roble y en combinación con una banda perimetral en acero inoxidable en dorado.

This is a combination of extraordinary materials for a family of tables that are not round or square, but rather lobed and above all majestic. The Chrysler Skyline, in 72 cm height. The table top is featured in the new porcelain tile Mont Blanc (Neolith), the base in natural oak wood in combination with a lower perimeter band made of stainless steel in gold colour.





## TECHNICAL DETAILS

## Mesa de reuniones.

Tapa de forma redondeada en cristal lacado o porcelánico Neolith, banda perimetral de acero Inox, base inferior en madera natural en combinación con una banda de acero Inox color.

## Meeting table.

Its cover has a rounded form in lacquered crystal or Neolith porcelain, stainless steel perimeter band, lower base in natural wood in combination with a coloured stainless steel band.

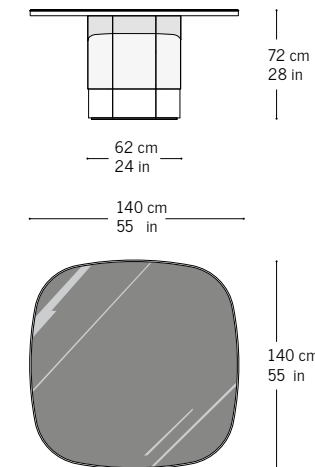

140x140 h 72 cm / 55x55 h 28 in

## NEW FINISHES

### CHRYSLER

José Martínez-Medina

---

Una combinación de materiales extraordinarios para una familia de mesas auxiliares que no son redondas ni cuadradas, sino algo lobuladas y sobre todo majestuosas. La colección Chrysler se presenta con la tapa en el nuevo porcelánico Mont Blanc (Neolith) y la base con bandas perimatrales en acero inoxidable color dorado, negro o bronce. También está disponible con la tapa en cristal lacado.

This is a combination of extraordinary materials for a family of auxiliar tables that are not round or square, but rather lobed and above all majestic. The Chrysler collection is presented with the cover in the new Mont Blanc porcelain (Neolith) and the base with perimeter bands in gold, black or bronze coloured stainless steel. It is also available with a lacquered glass top.







Feria Hábitat Valencia Stand



Orgatec Fair Stand. Cologne

## TECHNICAL DETAILS

## Mesa auxiliar.

Tapa en cristal lacado color o porcelánico (Neolith), base inferior con banda perimetral de acero inoxidable color.

## Auxiliary table.

Top in coloured lacquered glass or porcelain (Neolith), lower base with coloured stainless steel perimeter band.

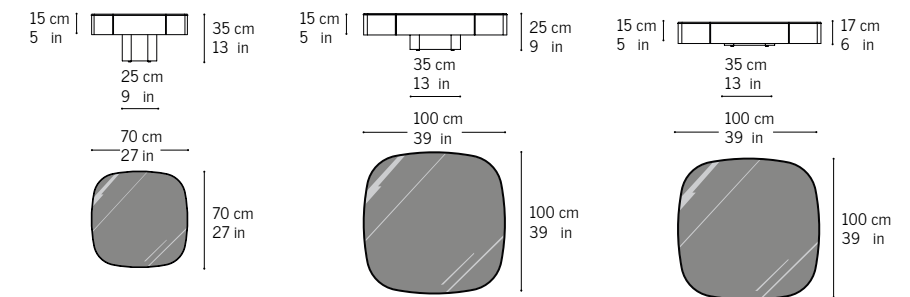

## FINISHES

Tapa en cristal lacado color blanco / negro o porcelánico (Neolith) Nero Marquina / Mont Blanc, base inferior con banda perimetral de acero inoxidable color dorado, bronce o negro.

Top in lacquered glass white / black or porcelain (Neolith) Nero Marquina / Mont Blanc, lower base with perimeter band in stainless steel gold, bronze or black.

70x70 h 35 cm /  
27x27 h 13 in

100x100 h 25 cm /  
39x39 h 9 in

100x100 h 17 cm /  
39x39 h 6 in

## TÉ

José Martínez-Medina

---

¿Quién no ha soñado con una mesa a la altura perfecta para tomar un té en el sofá, sin inclinarse y sin que peligre la tapicería? Para cumplir con este sueño, llega esta mesa auxiliar con tapa de madera de roble natural y estructura de tubo de hierro en acabado laca termo endurecida y color negro mate.

Who has not dreamed of a table at the perfect height for a tea on the sofa, without leaning and without endangering the upholstery? To fulfil this dream, here comes this side table with natural oak top and tubular iron structure in thermo-setting lacquered finish and matte black colour.







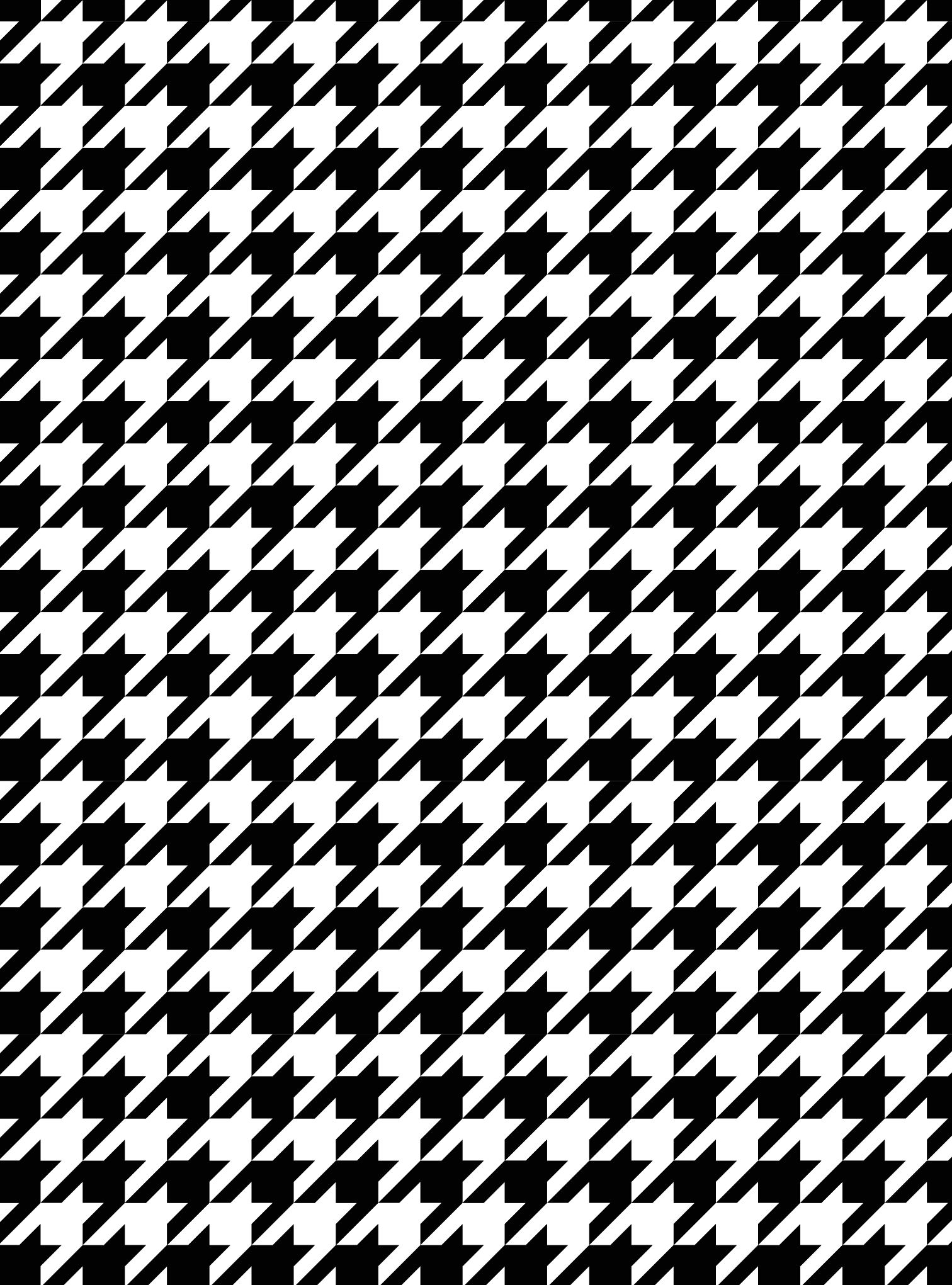

#### TECHNICAL DETAILS

Mesa auxiliar.  
Estructura de tubo de hierro. Tapa de madera  
o lacada.

Auxiliar table.  
Iron tube structure. Wooden top.

#### FINISHES

Estructura metálica, laca color negro mate.  
Tapa, en acabado madera o laca micro-  
texturada.

Metal frame lacquered in black matt color.  
Top in wood finish or micro-texturized finish.

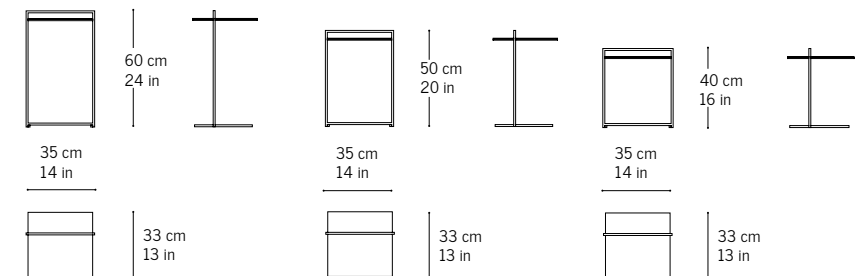

35x33 h 60 cm /  
14x13 h 24 in

35x33 h 50 cm /  
14x13 h 20 in

35x33 h 40 cm /  
14x13 h 16 in



**ACCESORIES**

**NEW****BACKSTAGE**

José Martínez-Medina

Ajustada a la pared, de forma autónoma en un espacio o como divisora de ambientes, esta estantería de gran formato propone múltiples posibilidades de ubicación. Está realizada a partir de perfiles extrusionados de hasta 5 milímetros, que hacen las veces de estantes, y de elementos que aportan estabilidad y rigidez a toda la pieza. Los estantes pueden ir forrados en madera, acero inoxidable de diferentes colores, mármol, etc. La luz también puede estar presente en Backstage, cuya parte trasera puede ir iluminada y lacada o bien tapizada.

Large format shelving with multiple possibilities of use: it can be adjusted to the wall, autonomously in the space, or as a divider of environments. Made from extruded profiles up to 5 millimeters that act as shelves and elements that add stability and rigidity to the whole piece. The shelves can be covered in wood, stainless steel of different colors, marble, etc. The back can be illuminated and lacquered or upholstered.





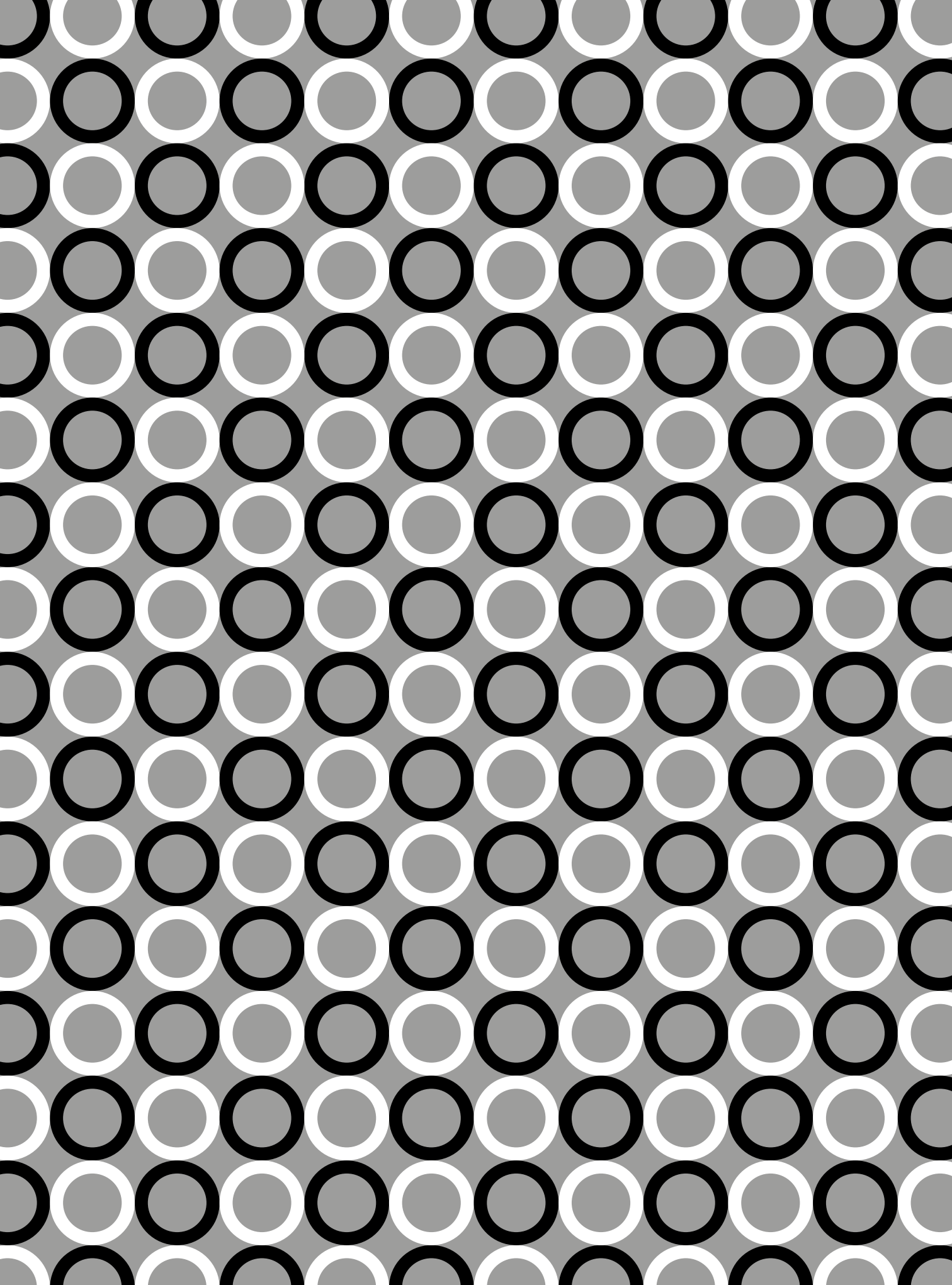



### TECHNICAL DETAILS

Estantería a pared o exenta. Formada por estantes de aluminio extrusionado. Posibilidad de recubrir los estantes con infinidad de materiales y acabados.

Cajonera: compuesta por 1 cajón de gran capacidad. Con ruedas ocultas.

Wall-mounted or free-standing shelving. Formed by extruded aluminium shelves. Possibility of covering the shelves with an infinite combination of materials and finishes.

Drawer unit: made up of 1 large-capacity drawer. Supplied with hidden wheels.

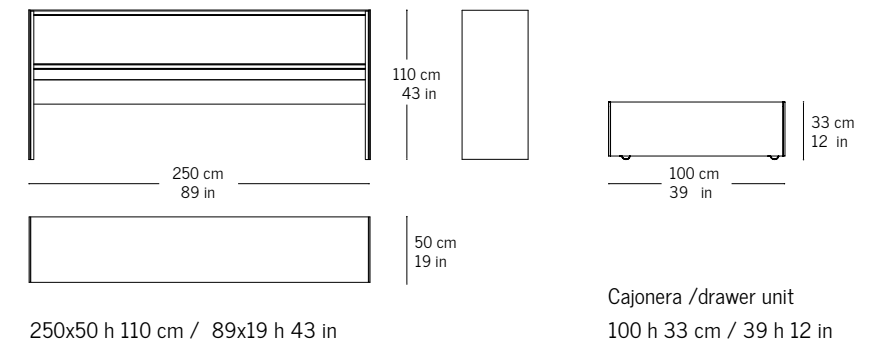

### FINISHES

Costados y estantes en acabado laca micro-texturada mate. Estantes recubiertos en acabado madera o laca mate.

\*Posibilidad de recubrir los estantes en otros materiales como aceros color, tapizados o lacas brillo. Consultar precios.

Cajonera: envoltente en acabado laca micro-texturada. Frente y trasera en acabado laca micro-texturada. Uñero superior en acabado acero inox.

Sides and shelves in matt micro-textured lacquered finish. Shelves covered in wood finish or matt lacquer.

\* Possibility of covering the shelves in other materials, such as coloured steels, upholstered or gloss lacquers. Ask for prices.

Drawer unit: covered in micro-textured lacquer finish. Front and back in micro-textured lacquer finish. Upper claw in stainless steel finish.

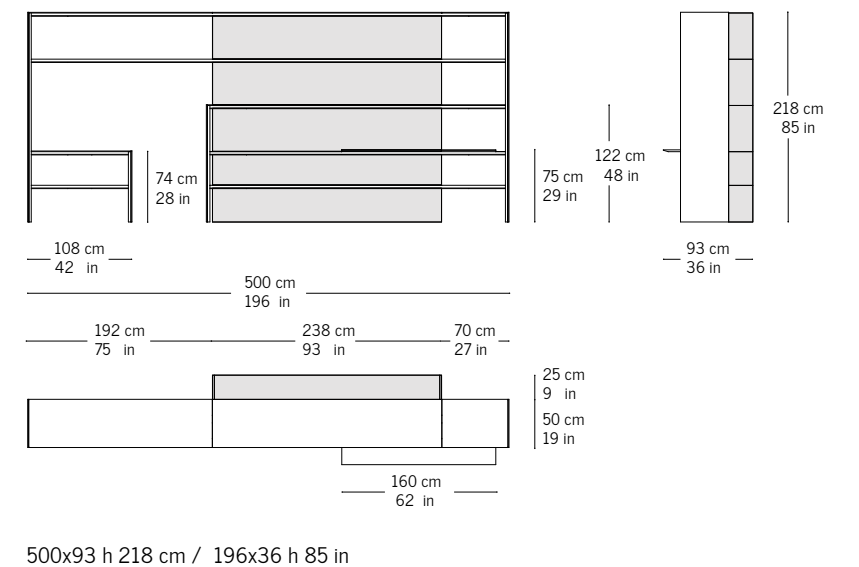

## NEW FINISHES

### COTA

José Martínez-Medina

La estantería Cota está hecha para albergar nuestros libros y objetos favoritos. Gracias a su estructura metálica con niveladores, donde se colocan los estantes y unas traseras deslizantes intercambiables, tenemos un mueble sólido y funcional con un diseño atractivo.

Cota shelving is made to keep your favourite books and objects. Thanks to its metallic structure with levellers, where the shelves are placed and interchangeable sliding rear shelves, we have a solid and functional furniture with an attractive design.

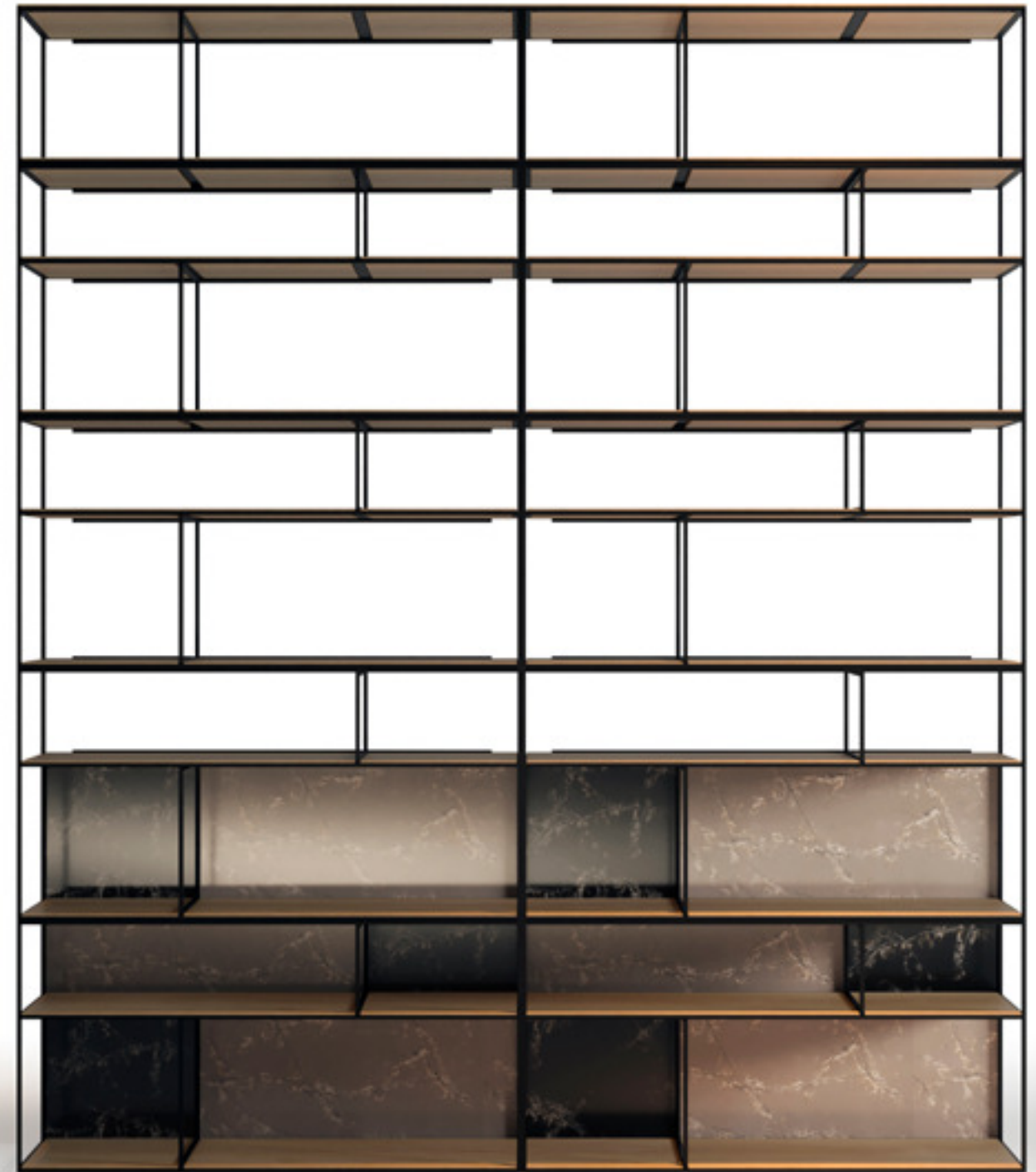











TECHNICAL DETAILS

Mueble estantería.  
Compuesto estructuras metálicas superpuestas y encajadas una sobre otra. Sobre estas estructuras se colocan los estantes y unas traseras deslizantes intercambiables.

Bookshelve.  
Composed of overlapping metal structures and embedded one on another. On these structures the shelves and interchangeable sliders are placed.

FINISHES

Estructura metálica y estantes, en acabado laca micro-texturada. Traseras, en acabado madera o laca micro-texturada.

Cota Petra: estructura metálica en acabado laca negra. Estantes, en acabado madera o laca micro-texturada. Traseras en COMPAC.

Metal structure and shelves, finished in micro-texturized lacquer. Sliders finished in wood or microtexturized lacquer.

Cota Petra: metal structure in black lacquer finish. Shelves finished in wood or microtexturized lacquer. Sliders in COMPAC.

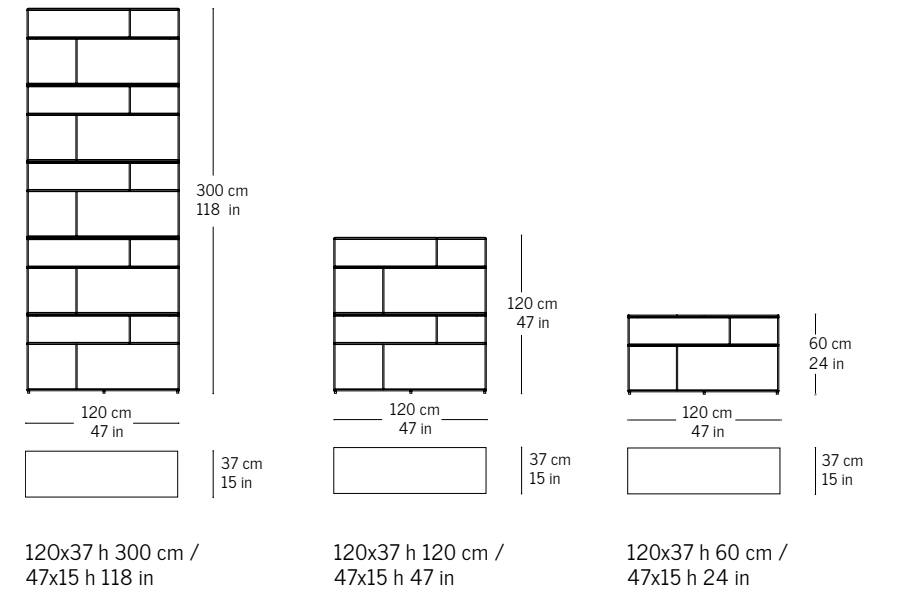

## OK CUBE

Francesc Rifé

---

Office kitchen. Un mueble que alberga y esconde todo lo necesario para poder servir de forma elegante y adecuada una bebida fría o caliente.  
Dispone de electrificación para los electrodomésticos más una máquina Nespresso y un frigo/botellero.  
Incluye leds de efecto.

Office kitchen. A cabinet that conceals the necessary kitchenware to properly serve a cold or hot drink.  
Fitted with electrification for appliances such as a Nespresso machine and a fridge/wine rack.  
Includes led lighting.



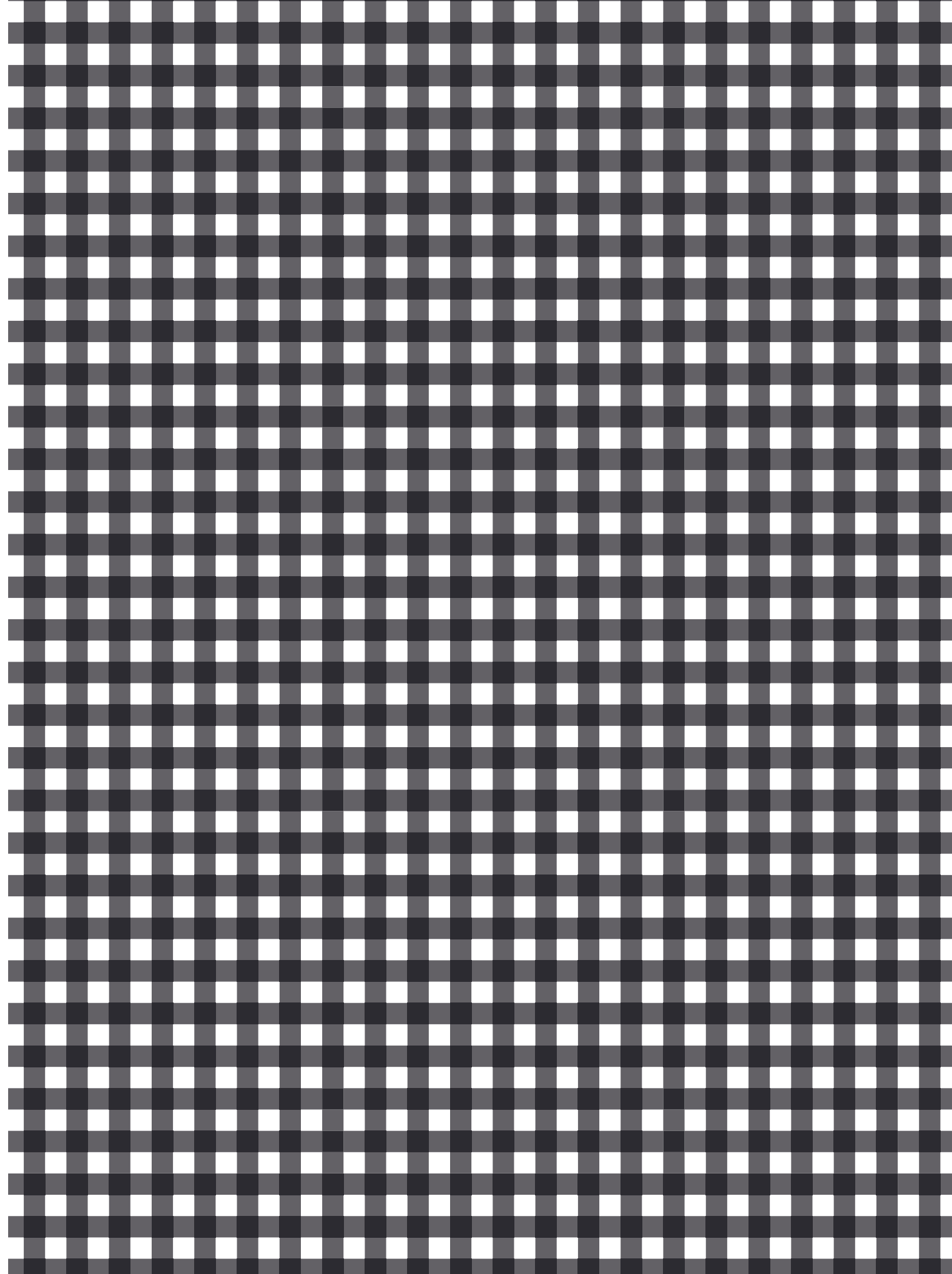



#### TECHNICAL DETAILS

##### OFFICE KITCHEN.

Mueble bar que alberga todo lo necesario para servir una bebida caliente o fría. Se compone de cajones con sistema Push y bandejas con retenida y cierre silencioso. La puerta va equipada con estantes para colocar botellas, vasos y copas. Posibilidad de electrificar para integrar electrodomésticos como una máquina Nespresso o frigo botellero. (Electrodomésticos NO INCLUIDOS). Incorpora LEDs de efecto en la puerta.

##### OFFICE KITCHEN.

Bar cabinet that conceals everything necessary to serve a cold or hot beverage. It includes drawers with Push opening system and retention silent closing trays. The door is equipped with shelves for bottles and glasses. Possible to electrify in order to integrate kitchen appliances such as a Nespresso machine or fridge (appliances NOT INCLUDED). Includes led lighting.

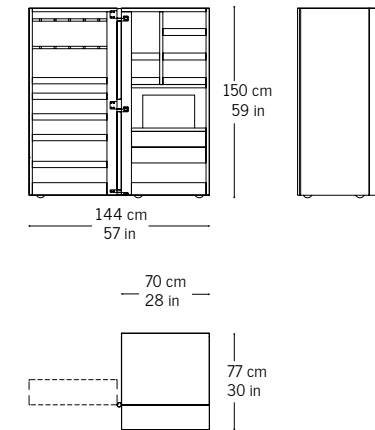

70x77 h 150 cm / 28x30 h 59 in

#### FINISHES

Envolvente, en acabado laca brillo. Interior, en acabado laca mate. Frente de estantes y cajones, en acero inox color. Sobre tapa de bandejas, en piel-tech. Bisagras, en níquel negro.

Los elementos en piel técnica del mueble (sobretapas, carpetas, sobre bandejas, etc...) irán en consonancia con la laca elegida.

Covering, in gloss lacquer finish. Interior, in matt laquer finish. Fronts of shelves and drawers in color stainless steel. Overtop on trays upholstered in tech-leather. Hinges in black nickel.

The technical leather elements from the furniture (overcaps, folders, on trays, etc...) will be in accordance with the selected lacquer.

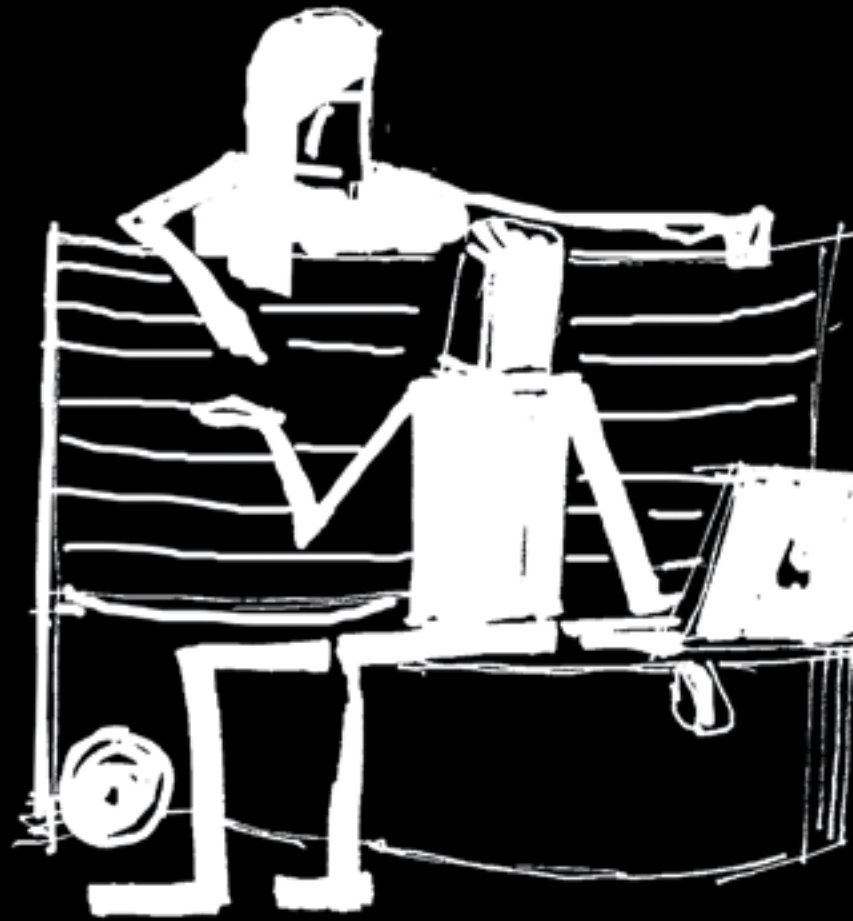



## UNIPERS

José Martínez-Medina

---







#### TECHNICAL DETAILS

##### Mesa polivalente.

Tapa lacada, con tablero elevado en laterales y parte posterior. Superficie tapizada en zona de trabajo. Equipada con 2 bandejas/plumier a ambos lados, dejando libre la zona central. Base metálica realizada en perfil cilíndrico macizo. Traba inferior combinando perfil metálico y madera.

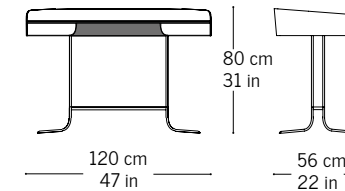

##### Multi-purpose table.

Lacquered top, with raised screen on back and sideboards. Upholstered surface on working area. Equipped with 2 pencil trays on both sides of the table, leaving the central area clear. Cylindrical solid extruded metal frame and legs. The structural bar combines solid wood and metal.

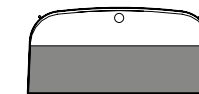

120x56 h 80 cm / 47x22 h 31 in

#### FINISHES

Tapa, en acabado lacado micro-texturado. Sobre tapa, tapizada en piel-tech. Fronteras y traba inferior, en acabado madera o laca micro-texturada. Estructura metálica, en acabado lacado.

Micro-texturized lacquer finish top. Upholstered working top in piel-tech. Drawer fronts and structural bar in wood or micro-texturized lacquer finish. Lacquer finish metal frame.

**FINISHES**

LAQUERS



Gris Concrete Mate  
Grey Concrete Matt



Beige Capuccino Mate  
Beige Capuccino Matt



Grey Ritz Mate  
Grey Ritz Matt



Gris Emporio Mate  
Grey Emporio Matt



Verde Harrods Mate  
Green Harrods Matt



Verde Toscana Mate  
Green Toscana Matt



Gris Concrete Brillo  
Grey Concrete Gloss



Beige Capuccino Brillo  
Beige Capuccino Gloss



Grey Ritz Brillo  
Grey Ritz Gloss



Gris Emporio Brillo  
Grey Emporio Gloss



Verde Harrods Brillo  
Green Harrods Gloss



Verde Toscana Brillo  
Green Toscana Gloss



Verde Olive Mate  
Green Olive Matt

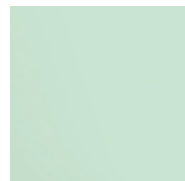

Verde Menta Mate  
Green Mint Matt



Azul Flight Mate  
Blue Flight Matt



Azul Summer Mate  
Blue Summer Matt



Azul Sky Mate  
Blue Sky Matt



Azul Cloud Mate  
Blue Cloud Matt



Verde Olive Brillo  
Green Olive Gloss



Verde Menta Brillo  
Green Mint Gloss



Azul Flight Brillo  
Blue Flight Gloss



Azul Summer Brillo  
Blue Summer Gloss



Azul Sky Brillo  
Blue Sky Gloss



Azul Cloud Brillo  
Blue Cloud Gloss



Amarillo Canary Mate  
Yellow Canary Matt



Amarillo Cream Mate  
Yellow Cream Matt

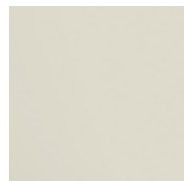

Beige Stone Mate  
Beige Stone Matt

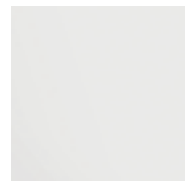

Blanco Frost Mate  
White Frost Matt



Rojo Calder Mate  
Red Calder Matt



Naranja Hermes Mate  
Orange Hermes Matt



Amarillo Canary Brillo  
Yellow Canary Gloss



Amarillo Cream Brillo  
Yellow Cream Gloss



Beige Stone Brillo  
Beige Stone Gloss



Blanco Frost Brillo  
White Frost Gloss



Rojo Calder Brillo  
Red Calder Gloss



Naranja Hermes Brillo  
Orange Hermes Gloss



Violeta Thai Mate  
Purple Thai Matt

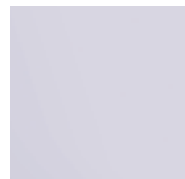

Violeta Skyline Mate  
Purple Skyline Matt



Grafito Mate  
Graphite Matt



Tórtola Mate  
Tortola Matt



Blanco Mate  
White Dull Matt



Marrón Bugatti Mate  
Brown Bugatti Matt



Violeta Thai Brillo  
Purple Thai Gloss



Violeta Skyline Brillo  
Purple Skyline Gloss



Grafito Metalizado Brillo  
Graphite Metallized Gloss



Tórtola Metalizado Brillo  
Tortola Metallized Gloss



Blanco Metalizado Brillo  
White Metallized Gloss



Marrón Bugatti Brillo  
Brown Bugatti Gloss



Negro Mate  
Black Matt



Azul Noche Mate  
Blue Night Matt



Marrón Caldera Mate  
Brown Caldera Matt



Negro Brillo  
Black Gloss



Azul Noche Brillo  
Blue Night Gloss



Marrón Caldera Brillo  
Brown Caldera Gloss

**TECHNICAL LEATHER**



Bone 013  
Bone 013  
Concrete 016  
Concrete 016  
Sand 007  
Sand 007  
Moka 008  
Moka 008  
Taupe 010  
Taupe 010  
Humus 014  
Humus 014



Hermes 001  
Hermes 001  
Boat 002  
Boat 002  
Loewe 011  
Loewe 011  
Slatb 006  
Slatb 006  
Caldero 003  
Caldero 003  
Toscana 020  
Toscana 020



Tamarind 028  
Tamarind 028

Aplicación Asiento  
 Material Vinilo 100%  
 Acabado Capa protectora  
 Respaldo Poliéster  
 Tamaño del perno 27 m - 30 yards  
 Peso 1004 gr/lm - 32.4 oz/ly  
 Anchura 137cm - 54 inches  
 Mantenimiento W/B - Limpar con limpiador a base de agua o blanqueador doméstico diluido.  
 Abrasión 140,000 double rubs  
 Inflamabilidad Este textil cumple con todos los requisitos de inflamabilidad apropiados para el asiento. Vea en el certificado los resultados de las pruebas.  
 Resistencia a la luz 40+ horas.

Application Seating  
 Material 100% Vinyl  
 Finish Protective Topcoat  
 Backing Polyester  
 Bolt Size 27 m - 30 yards  
 Weight 1004 gr/lm - 32.4 oz/ly  
 Width 137cm - 54 inches  
 Maintenance W/B-Clean with water-based cleanser or diluted household bleach.  
 Abrasion 140,000 double rubs  
 Flammability This textile meets all appropriate flammability requirements for seating. See flame certificate for test results.  
 Lightfastness 40+ hours.

**NATURAL LEATHER S 900 FUSION**



SF 900-902  
SF 900-903  
SF 900-911  
SF 900-925  
SF 900-927  
SF 900-936



SF 900-943  
SF 900-954

Inflamabilidad Flammability  
 BS 5852 Crib 5. UNE 23.727-90 (M2).  
 FAR/CS 25853 Appendix F. Part I (a)(1)(i) 60 seconds. UNE EN 1021-1&2  
 IMO norm MSC.61 (67), FTP code, Annex1, Part 8, Resolution A.652 (16)  
 Regulation 118/2 "European specification for public

Calidad Cuero de grano entero ligeramente pulido  
 Acabado Grano fino pigmentado y natural  
 Curtido Cromo  
 Espesor 1,0/1,2 mm - 0.04/0.05 inches  
 Colores 17  
 Medida media 5/5,3 s.q.m

Quality Full grain leather slightly buffed  
 Finish Pigmented and natural smooth grain  
 Tanning Chrome  
 Thickness 1,0/1,2 mm - 0.04/0.05 inches  
 Colours 17  
 Average size 5/5,3 s.q.m

**FABRIC EUROPOST** by Gabriel Design Team



Colour 60000 W40    Colour 62061 W25    Colour 60051 W25

Campos de aplicación	Contract	Fields of application	Contract
Material	Pura lana nueva espuma: pu respaldo: std. poliester	Material	Pure new wool foam: pu backing: std. polyester
Peso	1143 g/lm - 36.87 oz/lin.yd	Weight	1143 g/lm - 36.87 oz/lin.yd
Anchura	138 cm - 54 inches	Width	138 cm - 54 inches

**FABRIC FLOYD** by Åsa Pärson



Colour 0123    Colour 363    Colour 723    Colour 0923    Colour 0943    Colour 0783

	Tipo	Tapizado	Type	Upholstery
	Composición	45% lana nueva, 50% poliéster, 5% nailon	Composition	45% new wool, 50% polyester, 5% nylon
	Tipo de hilado	Estambre de lana	Yarn type	Worsted
	Unión	Tejido liso	Binding	Plain weave
	Peso	App. 370 g/lin.m	Width	App. 370 g/lin.m
	Anchura	App. 140 cm - App. 55 inches	Weight	App. 140 cm - App. 55 inches
	Repetición	Ninguna	Repeat	None

Colour 643

Inflamabilidad Flammability  
EN 1021-1/2. BS 5852 part 1 ignition source 0 US Cal. Bull. 117-2013  
IMO FTP Code 2010:Part 8  
With flame retardant treatment:  
BS 5852 part 1. BS 5852 Crib 5. No use of brominated flame retardants

**FABRIC GO CHECK** by Inger Mosholt Nielsen

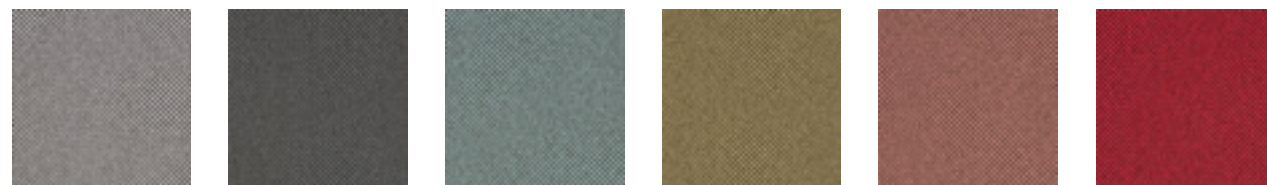

Colour 60079    Colour 60086    Colour 68168    Colour 61142    Colour 61183    Colour 64174

	Campos de aplicación	Contract
	Material	100% Trevira cs
	Peso	435 g/lm - 14.03 oz/lin.yd
	Anchura	140 cm - 55 inches
	Resistencia a la abrasión	rubs martindale (EN ISO 12947-2) 80,000 double rubs wyzenbeek (ASTM D415707) (tapicería de alta resistencia) 60,000
	Pilling	escala 1-5, max. 5 - EN ISO 12945-2 5
	Resistencia del color a la luz	escala 1-8, max. 8 - EN ISO 105-B02 5-8
	Resistencia del color al frotamiento	escala 1-5, max. 5 - EN ISO 105x12 (húmedo/seco) 4-5/4-5

Colour 66135

Inflamabilidad Flammability  
BS EN 1021 1&2 Cigarette and Match  
BS EN 1021-1 Cigarette  
BS 5852 Part 1 0, 1 Cigarette & Match  
BS5852 Crib 5  
BS 7176 Medium hazard  
DIN 4102 B1  
NFP 92-503/504/505 M1  
ONORM B 3825-B1-3800-Q1 UK

	Fields of application	Contract
	Material	100% Trevira cs
	Weight	435 g/lm - 14.03 oz/lin.yd
	Width	140cm - 55inches
	Abrasion resistance	rubs martindale (EN ISO 12947-2) 80,000 double rubs wyzenbeek (ASTM D415707) (heavy duty upholstery) 60,000
	Pilling	scale 1-5, max. 5 - EN ISO 12945-2 5
	Colour fastness to light	scale 1-8, max. 8 - EN ISO 105-B02 5-8
	Colour fastness to rubbing	scale 1-5, max. 5 - EN ISO 105x12 (wet/dry) 4-5/4-5

**FABRIC GO COUTURE** by Inger Mosholt Nielsen

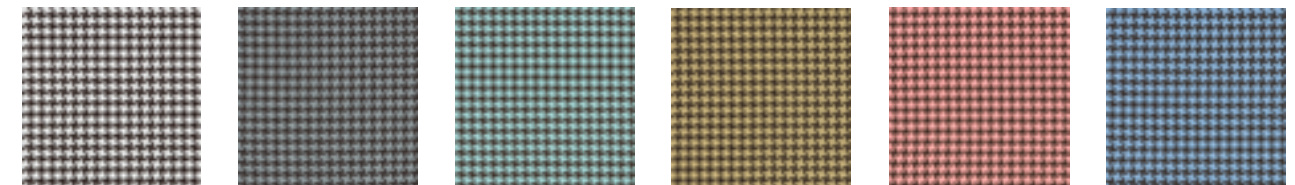

Colour 60079    Colour 60083    Colour 68168    Colour 61142    Colour 64183    Colour 66135

	Campos de aplicación	Contract
	Material	100% Trevira cs
	Peso	435 g/lm - 14.03 oz/lin.yd
	Anchura	140 cm - 55 inches
	Resistencia a la abrasión	rubs martindale (EN ISO 12947-2) 80,000
	Pilling	escala 1-5, max. 5 - EN ISO 12945-2 5
	Resistencia del color a la luz	escala 1-8, max. 8 - EN ISO 105-B02 5-8
	Resistencia del color al frotamiento	escala 1-5, max. 5 - EN ISO 105x12 (húmedo/seco) 4-5/4-5

Colour 68169

Inflamabilidad Flammability  
BS EN 1021 1&2 Cigarette and Match  
BS EN 1021-1 Cigarette  
BS 5852 Part 1 0, 1 Cigarette & Match  
BS5852 Crib 5  
BS 7176 Medium hazard  
DIN 4102 B1  
NFP 92-503/504/505 M1  
ONORM B 3825-B1-3800-Q1 UK

	Fields of application	Contract
	Material	100% Trevira cs
	Weight	435 g/lm - 14.03 oz/lin.yd
	Width	140cm - 55inches
	Abrasion resistance	rubs martindale (EN ISO 12947-2) 80,000
	Pilling	scale 1-5, max. 5 - EN ISO 12945-2 5
	Colour fastness to light	scale 1-8, max. 8 - EN ISO 105-B02 5-8
	Colour fastness to rubbing	scale 1-5, max. 5 - EN ISO 105x12 (wet/dry) 4-5/4-5

**FABRIC STEP MELANGE** by Inger Mosholt Nielsen and Cenk Kivrikoglu

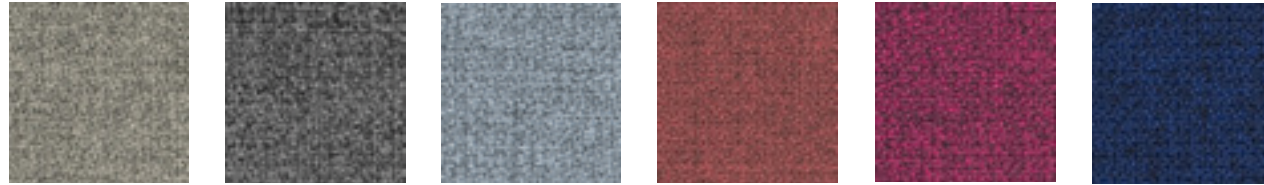

Colour 61104    Colour 60011    Colour 67004    Colour 64178    Colour 64177    Colour 66149



Colour 68160

Inflamabilidad Flammability  
 IMO MSC 307(88) Annex 1 part 8  
 MED Certificate IMO  
 DIN 4102 B1  
 NFP 92-503/504/505 M1  
 BS EN 1021 1&2 Cigarette and Match  
 BS EN 1021-1 Cigarette  
 BS 5852 Part 1 0.1 Cigarette & match  
 BS 5852 Crib 5  
 ÖNORM B 3825-B1-3800-Q1 UK  
 FAR/JAR 25.853 (a) (i) (ii)  
 BS 7176 Medium hazard  
 AM 18 - NF D 60-013-(only for fabric)  
 CA TB 117-2013  
 Class Uno UNI 9175 Class 1 | EMME  
 DIN EN 13501-1 B-s1,d0

Campos de aplicación	Contract
Material	100% Trevira cs
Peso	470 g/lm - 15.16 oz/linyd
Anchura	140 cm - 55 inches
Resistencia a la abrasión	rubs martindale (EN ISO 12947-2) 100,000
Pilling	double rubs wyzenbeek (ASTM D4157-07) (tapicería de alta resistencia) 100,000
Resistencia del color a la luz	escala 1-5, max. 5 - EN ISO 12945-2 4-5
Resistencia del color al frotamiento	escala 1-8, max. 8 - EN ISO 105-B02 5-7
	escala 1-5, max. 5 - EN ISO 105x12 (húmedo/seco) 4-5/4-5

Fields of application	Contract
Material	100% Trevira cs
Weight	470 g/lm - 15.16 oz/linyd
Width	140cm - 55inches
Abrasion resistance	rubs martindale (EN ISO 12947-2) 100,000
Pilling	double rubs wyzenbeek (ASTM D4157-07) (heavy duty upholstery) 100,000
Colour fastness to light	scale 1-5, max. 5 - EN ISO 12945-2 4-5
Colour fastness to rubbing	scale 1-8, max. 8 - EN ISO 105-B02 5-7
	scale 1-5, max. 5 - EN ISO 105x12 (wet/dry) 4-5/4-5

**WOOD**



Roble Claro Light Oak    Roble Medio Medium Oak    Roble Oscuro Dark Oak    Roble British British Oak    Roble Fume Fume Oak    Roble Tabaco Tobacco Oak

**WOOD PREMIUM**

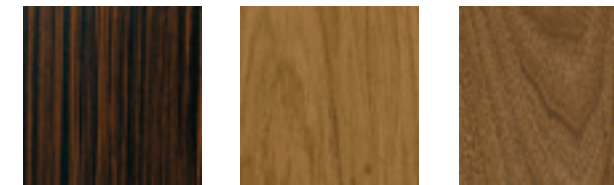

Ébano Macassar Macassar Ebony    Nogal Eco-3 Walnut Eco-3    Nogal Americano American Walnut



EDICIÓN MARZO 2020

MARCH 2020 EDITION

**Design & page layout**

PABLO GIRONÉS\_OFFICE

**Photography**

ÁNGEL SEGURA FOTO

**Photography pages 38-39, 48-49, 85, 86.**

DAVID ZARZOSO

**Illustrations**

PYSKUNOV



[www.blacktone.jmm.es](http://www.blacktone.jmm.es)

Black Tone es una marca propiedad de José Martínez Medina S.A.

Black Tone is a trademark owned by José Martínez Medina S.A.

**JOSÉ MARTÍNEZ MEDINA S.A.**

T +34 96 127 01 62

[jmm@jmm.es](mailto:jmm@jmm.es)

[export@jmm.es](mailto:export@jmm.es)

USA and CANADA:

**JMM AMERICA LLC**

[maloles@jmm.es](mailto:maloles@jmm.es)

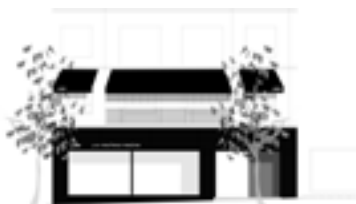

Showroom  
Cea Bermudez, 56 Madrid

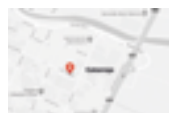

JMM Factory  
Camino del Bony, S/N  
Pol. Ind. Catarroja  
València

**jmm**  
jose martinez-medina

[www.blacktone.jmm.es](http://www.blacktone.jmm.es)