

# Agape tools volume 3 / accessories, taps, extras.

Rubinetti / Taps / Armaturen / Robinetterie / Griferia — 004,  
Accessori / Accessories / Accessoires / Accessoires / Accesorios  
— 072, Complementi / Extras / Zubehör / Complements  
/ Complementos — 112.



**Agape tools 3:**  
**Rubinetti/Taps/Armaturen/Robinetterie**  
**/Grifería** → pag 004, **Accessori/Accessories/ Acces-**  
**soires/Accessoires/Accesorios** → pag 072,  
**Complementi/Extras/Zubehör/Compléments**  
**/Complementos** → pag 112.

**Designed by:**  
Benedini Associati,  
Daniele Borin/Nicola  
Gibertini/Mattia Vittori,  
Fabio Bortolani,  
/Ermanno Righi,  
Alessandro Farnetti,  
Marco Ferreri,  
Giulio Gianturco,  
Konstantin Grcic,  
Nicolas Gwenaël  
/Curiosity,  
Claudio La Viola,  
Maurizio Negri,  
Marco Zito,  
UT Agape.

Un mondo in cui  
immergersi

Un mondo più bello, abitato da forme amichevoli ed affascinanti, ricco di possibilità ed emozioni. È il bagno Agape: un ambiente accogliente, luminoso e creativo nel quale la semplicità nasce da uno studio approfondito, l'estetica non è mai separata dalla funzione, la natura e la tecnologia convivono in armonia. Agape vi dà il benvenuto in questo mondo e vi invita a viverlo con libertà e piacere: in tutti i suoi momenti ed elementi.

Indice analitico → 137  
 Glossario materiali  
 → 140

Immerse yourself in  
a new world

A more attractive world, inhabited by friendly and appealing shapes, rich in possibilities and emotions. This is the Agape bathroom: a welcoming, light-filled and creative room in which simplicity is born of in-depth - research, aesthetics is never separated from function and nature and technology live together in harmony. Agape welcomes you to this world and invites you to experience it with freedom and enjoyment, in all its moments and in all its parts.

Contents → 137  
 Glossary of materials  
 → 140

Eine Welt, in die man  
eintauchen kann

Eine schönere Welt, bewohnt von freundlichen und faszinierenden Formen, reich an Möglichkeiten und Emotionen. So ist ein Bad von Agape: ein gemütliches Ambiente, hell und kreativ, in dem Schlichtheit durch gründliche Studien entsteht, Ästhetik stets mit Funktion verbunden ist und Natur und Technologie in Harmonie nebeneinander bestehen. Agape heißt Sie in dieser Welt willkommen, die Sie in aller Freiheit und mit Freude erleben mögen: in allen ihren Momenten und Elementen.

Inhalt → 137  
 Glossar Materialien  
 → 140

Un monde où  
s'immerger

Un monde plus beau, habité de formes amicales et fascinantes, riche de possibilités et d'émotions. Telle est la salle de bain Agape: un milieu accueillant, lumineux et créatif dans lequel la simplicité naît d'une étude approfondie, l'esthétique n'est jamais séparée de la fonction, la nature et la technologie cohabitent en harmonie. Agape vous donne la bienvenue dans ce monde et vous invite à le vivre avec liberté et volupté: dans tous ses instants et éléments.

Index → 137  
 Glossaire des  
 matériaux → 140

Un mundo en el cual  
sumergirse

Un mundo más hermoso en el que viven formas afables y fascinantes, rico en posibilidades y emociones. Es el baño Agape: un espacio acogedor, luminoso y creativo en el que la sencillez nace de un estudio profundo, la estética nunca se separa de la función y la naturaleza convive armoniosamente con la tecnología. Agape les da la bienvenida en este mundo y les invita a vivirlo con libertad y placer: en todos sus momentos y con todos sus elementos.

Índice → 137  
 Glosario de materiales  
 → 140

Una collezione con il giusto grado di tecnologia e di design, per completare e personalizzare il bagno Agape. Rubinetti esterni, a incasso, monocomando o con due comandi. Realizzati in ottone, acciaio inox o alluminio, sono caratterizzati da un design originale e da una qualità totale.

A collection with the right mix of technology and design, to complement and customise your Agape bathroom. External and recessed taps, with single or dual controls, produced in brass, stainless steel or aluminium, and featuring an original design and absolute quality.

Eine Kollektion mit der richtigen Mischung von Technologie und Design, um das Badezimmer Agape im individuellen Stil zu komplettieren. Aufputz- oder Unterputzarmaturen, Einhand- oder Zweihandbedienung. Alle im eigenwilligen Design und von hochwertiger Qualität, werden sie aus Messing, rostfreiem Stahl oder Aluminium hergestellt.

Une collection réunissant la juste dose de technologie et de design, pour compléter et personnaliser la salle de bains Agape. Robinets apparents, encastrés, monocommande ou bicommande. Réalisés en laiton, acier inox ou aluminium, ils sont caractérisés par un design original et une qualité totale.

Una colección con mezcla exacta de tecnología y diseño, para completar y personalizar el baño Agape. Grifos de superficie o encastrados, mono o bimando. Fabricados en latón, acero inoxidable o aluminio, y caracterizados por un diseño original y total calidad.

# Agape tools 3: Rubinetti / Taps / Armaturen / Robinet- terie / Grifería → pag 006.

## pag

006, 008, 010, 012, 014, 016, 018	Fez
020, 022, 024, 026 028, 030, 032, 034, 036, 038	Memory Sen
040, 042, 044, 046, 048, 050, 052 054, 056, 058	Square Suite

## Complementi per rubinetteria

	/ Tapware extras
060	Al dente
062	ARUB 400 / 401
064	Hydro
066	Kaa
068, 070	Doccette e soffioni / Handheld showers and shower heads

**Fez** / 1999

Una forma inconfondibile per una collezione completa di miscelatori monoforo per lavabo, disponibili con tre maniglie e in diverse dimensioni. Tutti i gruppi sono realizzati in ottone cromato lucido, spazzolato o laccati in bianco.

An unmistakable shape for a complete collection of single-hole basin mixer taps, available with three different types of handle and in various sizes. All tap sets are made of polished brushed or chrome-plated brass, or with a white lacquer finish.

Eine unverkennbare Form für eine vollständige Kollektion von Einhandmischern für das Waschbecken, mit drei Arten von Bedienungshebeln und in verschiedenen Maßen. Alle Armaturen aus verchromtem Messing glänzend oder gebürstet, oder weiß lackiert.

Une forme incomparable pour une collection complète de mitigeurs monotrou pour lavabos, disponibles avec trois types de leviers et en différentes dimensions. Tous les groupes sont réalisés en laiton chromé poli, brossé ou en laqué blanc.

Una forma inconfundibile para una colección completa de mezcladores monomando para lavabo, disponibles con tres tipos de manillas y en distintos tamaños. Todos los grupos están fabricados en latón cromo brillo, cepillado o barnizados en blanco.



design Benedini Associati

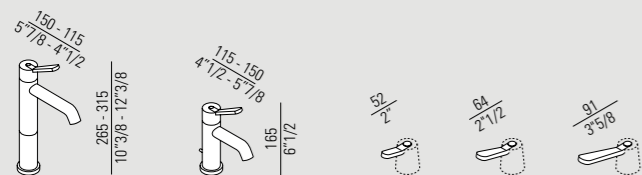

Finiture / Finishes



○  
**Nivis**  
lavabo, washbasin,  
waschbecken, lavabo,  
lavabo  
→ Tools vol. 1

○  
**Flat XL**  
programma, range,  
programm, programme,  
programa  
→ Tools vol. 5

**Fez** / 1999

Un gruppo lavabo da incasso formato da miscelatore monocomando e bocca di erogazione, tre tipologie di maniglia e bocche in varie misure.

A recessed basin tap set consisting of a single-control mixer and outlet spout, with three types of handle and spouts in various sizes.

Eine Unterputzarmatur für Waschbecken mit Einhandmischer und Wasserauslauf, drei Arten von Bedienungshebeln und Ausläufen in verschiedenen Maßen.

Un groupe lavabo encastrable formé d'un mitigeur monocommande et d'un bec d'écoulement, trois types de leviers et becs de dimensions diverses.

Grifería de encastrado para lavabo formada por mezclador monomando y boca de erogación, tres tipos de manillas y bocas de varios tamaños.



design Benedini Associati



Finiture / Finishes



○  
**Vieques**  
lavabo, washbasin,  
waschbecken, lavabo,  
lavabo  
→ Tools vol. 1

**Fez** / 1999

Fez è un concetto di design versatile che si adatta a diverse situazioni, con una personalità unica: dalla versione a terra per completare un lavabo freestanding, al modello da bidet.

Fez is a versatile design concept adaptable to a range of situations, but with a unique personality: from the floor-mounted version to complete a freestanding washbasin, to the model for bidets.

Fez zeichnet sich durch ein vielseitiges Design aus, das sich an unterschiedliche Gegebenheiten mit einer starken Persönlichkeit anpasst: von der Standarmatur für einen freistehenden Waschtisch bis zum Modell für das Bidet.

Fez est un concept de design polyvalent qui s'adapte à différents contextes avec une personnalité unique: de la version au sol pour compléter un lavabo colonne, au modèle pour bidet.

Fez es un concepto de diseño versátil que se adapta a distintas situaciones, con una personalidad única: desde la versión apoyada en el suelo para un lavabo independiente hasta el modelo para bidé.



design Benedini Associati

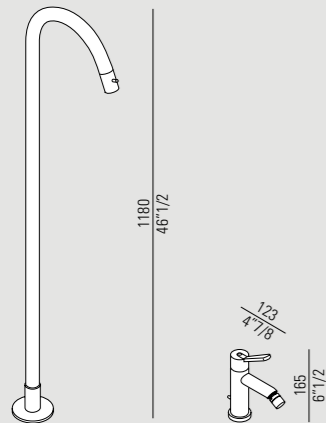

Finiture / Finishes



**Nivis**

lavabo, washbasin,  
waschbecken, lavabo,  
lavabo

→ Tools vol. 1

**Fez** / 1999

Fez rivela la sua flessibilità anche nella vasca da bagno e nello spazio doccia, con gruppi specifici sempre caratterizzati da un inconfondibile design.

Fez proves equally flexible in the bathtub or shower, with purpose-made sets, all featuring the same unmistakable design.

Vielseitigkeit beweist Fez auch bei Badewannen und Duschen mit spezifischen Armaturen, die durch ein unnachahmliches Design bestechen.

Fez révèle sa flexibilité aussi pour la baignoire et l'espace douche, avec des groupes spécifiques toujours caractérisés par un design unique.

Fez revela su flexibilidad también en la bañera y en el espacio para la ducha, con grupos específicos que se caracterizan por un diseño inconfundible.



design Benedini Associati

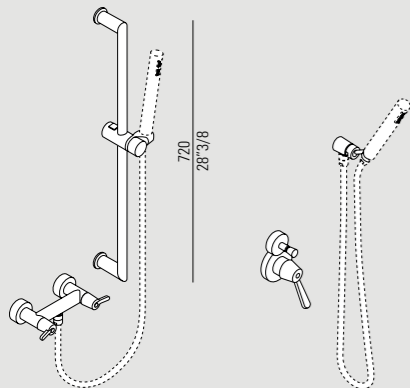

Finiture / Finishes





**Fez** / 1999

Versione a pavimento del rubinetto Fez: un pezzo importante che caratterizza l'intera stanza da bagno.

Floor-mounted version of the Fez tap: a striking piece that stamps its character on the entire bathroom.

Fez in der Ausführung als Standarmatur: ein prägendes Element, das dem Badezimmer einen besonderen Charakter verleiht.

Version au sol du robinet Fez. Une pièce importante qui caractérise toute la salle de bains.

Grifería Fez a suelo: una pieza importante que personaliza todo el cuarto de baño.



design Benedini Associati

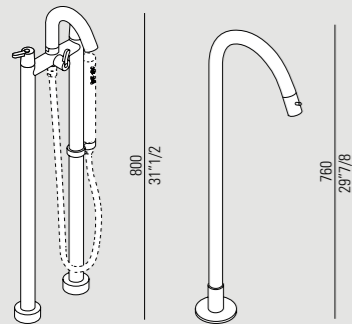

Finiture / Finishes



○  
**Slim**  
specchio, *mirror*,  
spiegel, *miroir*, *espejo*  
→ Tools vol. 4

○  
**Normal**  
vasca, *bathub*, *badewanne*,  
*baignoire*, *bañera*  
→ Tools vol. 2

**Fez** / 1999

Una proposta completa di rubinetteria per ogni esigenza nell'ambiente bagno, nelle versioni cromato lucido, spazzolato o verniciato in bianco.

A complete range of taps for all bathroom needs, in polished chrome or with a white painted finish.

Eine komplette Linie von Armaturen für jeden Bedarf im Badezimmer, in den Ausführungen verchromt glänzend oder gebürstet, oder weiß lackiert.

Une proposition complète de robinetterie pour toutes les exigences de la salle de bains dans les versions en chromé poli, brossé ou laqué blanc.

Una propuesta completa de grifería para cualquier exigencia en el espacio baño, en las versiones cromo brillo, cepillado o lacado en blanco.

**Lavabo / Washbasin**

ARUB10012SL\_ / ARUB100120L\_  
ARUB10015SL\_ / ARUB100150L\_

ARUB102150L\_

ARUB10112SL\_ / ARUB101120L\_  
ARUB10115SL\_ / ARUB101150L\_

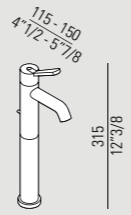
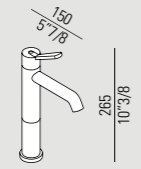
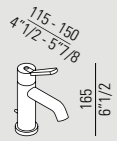

ARUB120150C\_ / ARUB120200C\_  
/ ARUB120250C\_

ARUB130150C\_ / ARUB130200C\_  
/ ARUB130300C\_

ARUB1460000\_

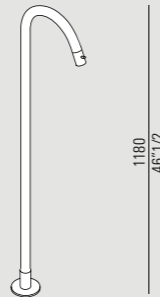
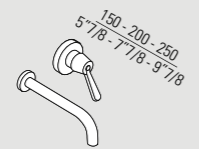
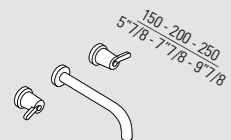

**Bidet / Bidet**

ARUB07012SL\_

**Doccia / Shower**

.CRUB0900L\_

.CRUB0920L\_

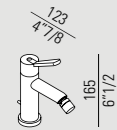

**Doccia / Shower**

.CRUB0929L\_

.CRUB0928L\_

ARUB060000L\_

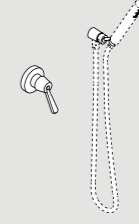
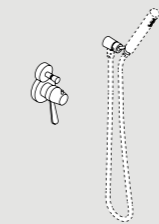
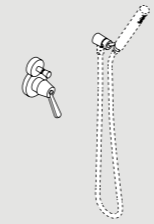

ARUB063000L\_

ARUB269000L\_

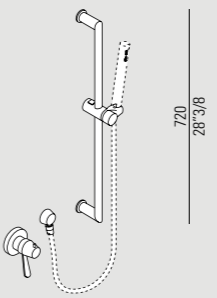
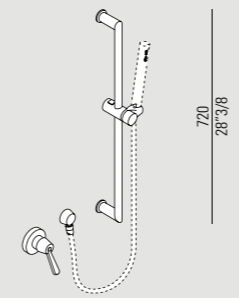

ARUB261000L\_

ARUB263000L\_

ARUB265000L\_

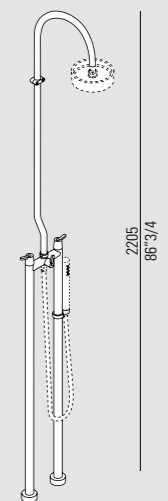
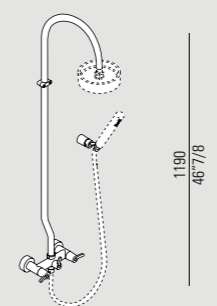
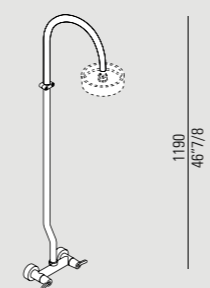

Vasca / Bathtub

ARUB05000L\_

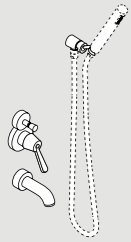

ARUB190000C\_

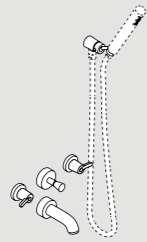

ARUB051000L\_

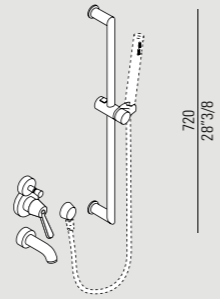

ARUB191000C\_

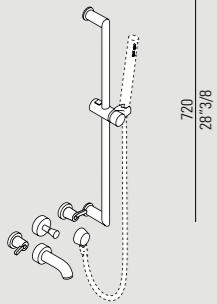

ARUB1400000\_

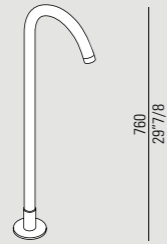

ARUB1450000\_

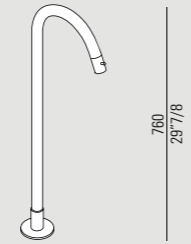

ARUB170000C\_

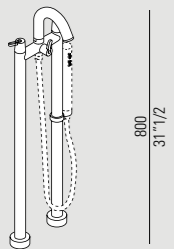

ARUB170W000C\_



**Memory** / 2009

Tradizione e attualità si fondono in Memory, una collezione che si ispira al passato per completare e personalizzare il bagno contemporaneo. Realizzati in ottone cromato, sono caratterizzati dalla maniglia a croce.

Memory blends tradition with modernity, giving a collection inspired by the past to complete and customise the contemporary bathroom. Made of chrome-plated brass, they feature a cross headed handle.

Tradition und Aktualität verschmelzen in Memory, Armaturen, die sich von der Vergangenheit inspirieren lassen, um Badezimmer mit zeitgemäßer Persönlichkeit zu vervollständigen. Hergestellt aus verchromtem Messing, mit Bedienungshebel in charakteristischer Kreuzform.

La tradition et la modernité se fondent dans Memory, une collection qui s'inspire du passé pour compléter et personnaliser la salle de bains contemporaine. Réalisés en laiton chromé, ils sont caractérisés par la poignée en forme de croix.

Tradición y actualidad se unen en Memory, una colección que se inspira en el pasado para completar y personalizar el baño contemporáneo. Fabricados en latón cromado, se caracterizan por la manilla cruciforme.

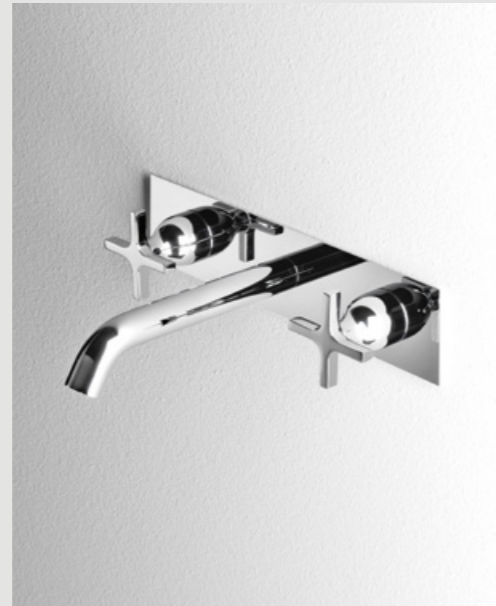

design Benedini Associati

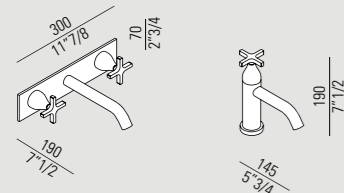

**Surf** ○  
accessori, *accessories*,  
*accessoires*, *accessoires*,  
*acesorios*  
→ Tools vol. 3



**Evo-E2**  
*programma*, *range*, *programm*,  
*programme*, *programa*  
→ Tools vol. 5



**Memory** / 2009

L'essenziale gruppo doccia da parete è fortemente caratterizzato dalla forma a croce delle manopole.

This essential wall-mounted shower set features a bold cross headed handle.

Die minimalistische Wandarmatur erhält durch die Kreuzform der Bedienungshebel den besonderen Charakter.

Le groupe de douche mural, aux lignes essentielles, est fortement caractérisé par les poignées en forme de croix.

La forma cruciforme de sus mandos distingue a esta grifería a pared.



design Benedini Associati

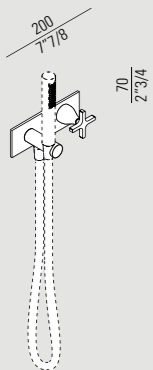

**Memory** / 2009

Diverse soluzioni studiate per la vasca bagno: a parete o a pavimento, con o senza doccetta flessibile integrata.

A range of solutions created for the bathtub: wall- or floor-mounted, with or without an integrated flexible hand shower.

Verschiedene Lösungen für die Badewanne: Wand- oder Standarmatur, mit oder ohne integrierte Handbrause.

Différentes solutions sont proposées pour la baignoire : version murale, au sol, avec ou sans douchette flexible intégrée.

Varias soluciones pensadas para la bañera: a pared o a suelo, con o sin duchador flexible integrado.



design Benedini Associati

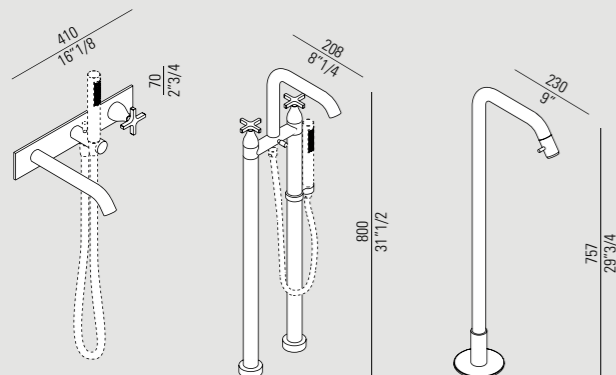

**Normal**  
vasca, bathtub, badewanne,  
baignoire, bañera  
→ Tools vol. 2

**Memory** / 2009

Realizzati in ottone cromato, i rubinetti Memory si distinguono per il design a croce delle manopole e per gli aeratori a scomparsa.

Memory taps in chrome-plated brass feature distinctive cross headed handles and hidden aerators.

Die Armaturen Memory aus verchromtem Messing werden durch die kreuzförmigen Bedienungshebel und unsichtbar eingebaute Perlatoren optisch geprägt.

Réalisés en laiton chromé, les robinets Memory sont caractérisés par le design des poignées en croix et par les aérateurs invisibles.

Fabricada en latón cromado, la grifería Memory se distingue por el diseño cruciforme de sus mandos y por sus aireadores invisibles.

\* con cartuccia progressiva

\* with progressive cartridge

\* mit progressiver Kartusche

\* avec cartouche progressive

\* con cartucho progresivo

**Lavabo / Washbasin**

\* ARUB1035S

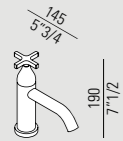

\* ARUB1071S

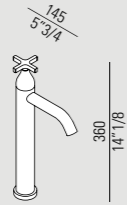

\* ARUB1079S

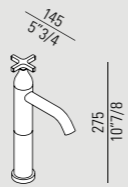

ARUB1039S

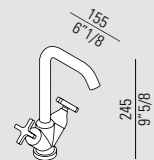

ARUB1030S

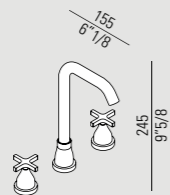

ARUB1031S

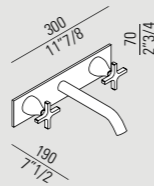

\* ARUB1036S

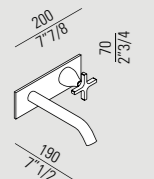

ARUB1087S

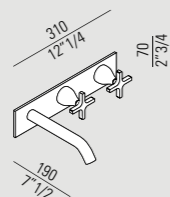

\* ARUB1038S

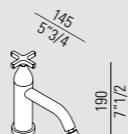

**Bidet / Bidet**

**Vasca / Bathtub**

\* ARUB1076S

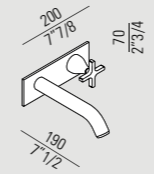

ARUB1089S

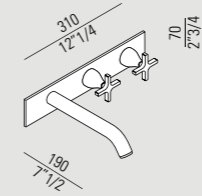

\* ARUB1077S

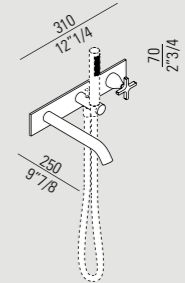

ARUB1040S

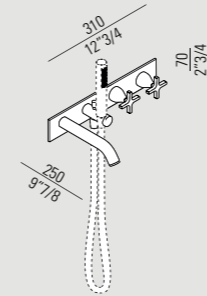

ARUB1091S

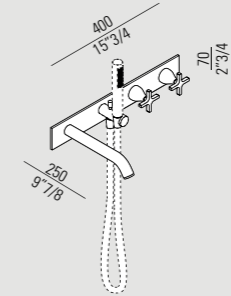

ARUB1078S

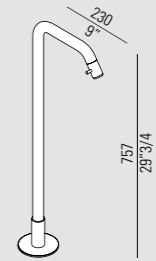

**Vasca Doccia / Bathtub Shower**

ARUB1033S

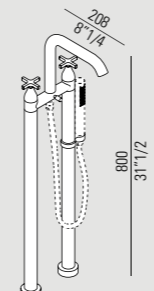

\* ARUB1032S / ARUB1085S / ARUB1086S



\* ARUB1075S

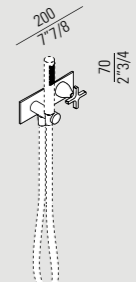

\* ARUB1034S

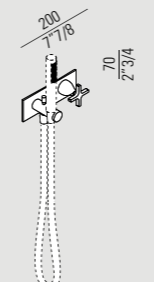

ARUB1085S

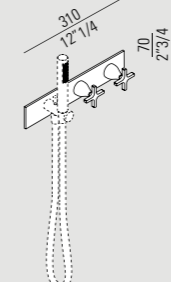

ARUB1074S / ARUB1073S

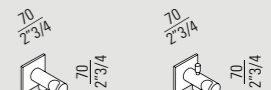

**Sen** / 2008

Sintesi di spirito orientale e tecnologia occidentale, Sen integra molteplici funzioni in una linea di elementi indipendenti, liberamente componibili e fortemente caratterizzanti, anche grazie alla matericità dell'alluminio spazzolato nero.

A combination of Eastern spirit and Western technology, Sen incorporates multiple functions in a line of independent components which can be freely combined to make a distinct style statement, further enhanced by the striking texture of the black brushed aluminium.

Sen, Synthese aus östlicher Philosophie und westlicher Technik, vereinigt vielfältige Funktionen in einer Reihe unabhängiger Elemente, die frei miteinander kombinierbar sind und starke Akzente setzen, auch durch den stofflichen Charakter von gebürstetem Aluminium in schwarzer Farbe.

Synthèse d'esprit oriental et de technologie occidentale, Sen intègre de multiples fonctions dans une ligne d'éléments indépendants, librement composables et fortement caractérisants, y compris grâce à l'effet matière de l'aluminium brossé noir.

Síntesis de espíritu oriental y tecnología occidental, Sen integra múltiples funciones en una línea de elementos independientes, de libre composición y con personalidad bien definida, gracias también a la consistencia matérica del aluminio cepillado negro.

– selezione, *selection*  
ADI Design Index, 2009



**Spoon XL**  
lavabo, *washbasin*,  
*waschbecken*, lavabo,  
*lavabo*  
→ Tools vol. 1

design Nicolas Gwenael, Curiosity

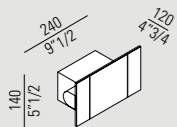

**In-Out**  
lavabo, *washbasin*,  
*waschbecken*, lavabo,  
*lavabo*  
→ Tools vol. 1



**Sen** / 2008

Il design minimale di Sen trova ulteriori declinazioni nelle versioni monoforo per lavabo proposte in due altezze per miscelatori su piano e una per miscelatore a pavimento.

Sen's minimal design is further interpreted in the single-hole versions for washbasin, available in two heights for basin-mounted mixer taps and one for a floor-mounted mixer.

Weitere Varianten des minimalistischen Designs von Sen in den Einloch-mischern für Waschbecken, in zwei Höhen für deckmontierte und einer Höhe für Standarmatur.

Le design minimaliste de Sen trouve de nouvelles déclinaisons dans les versions monotrou pour lavabo proposées en deux hauteurs pour mitigeurs sur plan et pour mitigeur au sol.

El diseño minimalista de Sen se reinterpreta en las versiones monomando para lavabo, disponibles en dos alturas diferentes: una para mezcladores sobre encimera y la otra para mezcladores a suelo.



design Nicolas Gwenael, Curiosity

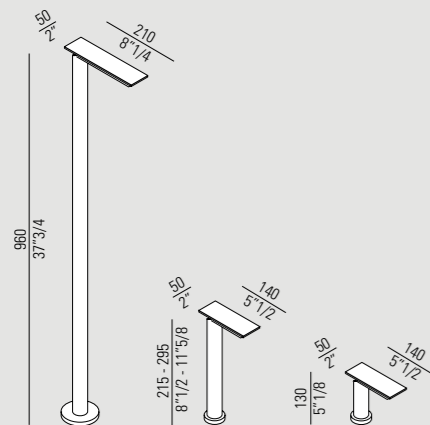

**Vieques**  
lavabo, washbasin,  
waschbecken, lavabo,  
lavabo  
→ Tools vol. 1



**Sen** / 2008

Una duplice proposta per la vasca: a parete con un completo sistema modulare di rubinetteria e accessori, oppure a pavimento con un unico pezzo essenziale e importante.

Two proposals for the bathtub: a complete modular wall-mounted system of taps and accessories, or floor-mounted as a single, bold, essential element.

Ein doppelter Vorschlag für die Badewanne: ein komplettes modulares System von Armaturen und Zubehör für Wandmontage, oder eine Standarmatur, aus einem einzigen Element im minimalistischen, den Raum prägenden Design.

Une double proposition pour la baignoire : version murale avec un système modulaire complet incluant robinetterie et accessoires, ou au sol avec une pièce unique, essentielle et importante.

Una doble propuesta para la bañera: versión de pared con un sistema modular con grifería y accesorios, o a suelo, con una pieza única, esencial e importante.

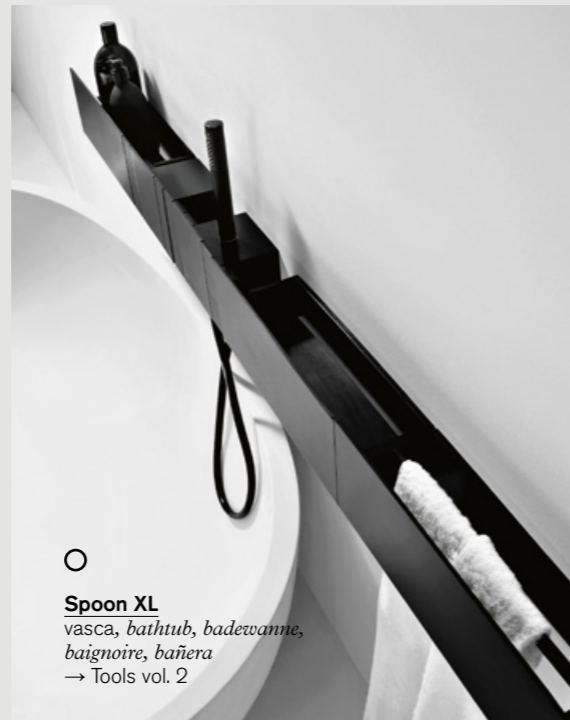

○  
**Spoon XL**  
vasca, bathtub, badewanne,  
baignoire, bañera  
→ Tools vol. 2

design Nicolas Gwenael, Curiosity

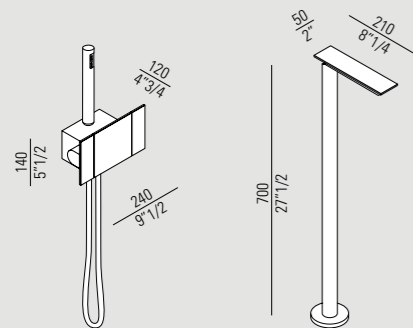

○  
**O.L.C**  
accessori, accessories,  
accessoires, accessoires,  
accesorios  
→ Tools vol. 3

○  
**In-Out**  
vasca, bathtub, badewanne,  
baignoire, bañera  
→ Tools vol. 2



**Spoon XL**  
vasca, bathtub, badewanne,  
baignoire, bañera  
→ Tools vol. 2

**Sen** / 2008

Sen completa e personalizza lo spazio doccia con un elemento orizzontale o una colonna verticale a cui si possono affiancare gli altri elementi dedicati a questo spazio di benessere e rigenerazione.

Sen completes and customises the shower space with a horizontal element or a vertical column, which can be combined with complementary elements dedicated to this area of well-being and regeneration.

Sen vervollständigt die Dusche nach individuellem Geschmack durch ein horizontales Element oder eine vertikale Säule, die durch weitere Elemente ergänzt werden kann, um diesen Wohlfühlbereich zusätzlich zu bereichern.

Sen complète et personnalise l'espace douche avec un élément horizontal ou une colonne verticale auxquels peuvent être associés les autres éléments dédiés à cet espace de bien-être et de régénération.

Sen completa y personaliza el espacio ducha con un elemento horizontal o de columna vertical, con los que se pueden combinar los demás elementos dedicados a este espacio de bienestar y regeneración.

**Flat D**

doccia, shower, dusche,  
douche, ducha

→ Tools vol. 2

design Nicolas Gwenaël, Curiosity

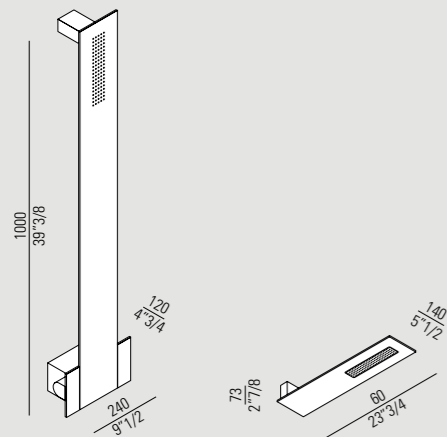

**Sen** / 2008

La rubinetteria e gli accessori Sen sono realizzati in alluminio anodizzato, con finitura spazzolato nero. Per un corretto montaggio utilizzare la barra in acciaio da incassare nella muratura che permette di stabilire perfettamente la distanza tra due gruppi ad incasso o collegati da accessori.

Sen taps and accessories are made of anodised aluminium, with a black brushed finish. For correct installation use the steel bar to be immured, that permits to define exactly the distance between two built-in tap sets even if connected by accessories.

Armaturen und Accessoires Sen sind aus eloxiertem Aluminium, Oberfläche mit schwarz gebürsteter. Für korrekte Montage die in die Mauer einzulassende Stahlschiene verwenden, zur genauen Bestimmung des Abstands zwischen zwei Unterputzarmaturen, auch wenn diese durch Accessoires verbunden sind.

La robinetterie et les accessoires Sen sont réalisés en aluminium anodisé, avec finition brossée noire. Pour un correct montage utiliser la barre en acier à encastrer dans le mur, qui permet d'établir parfaitement la distance entre deux groupes à encastrement ou joints par des accessoires.

La grifería y los accesorios Sen están realizados en aluminio anodizado, con acabado cepillado negro. Para un correcto montaje utilizar la barra de acero para encastrar en el muro, que permite definir perfectamente la distancia entre dos grupos de encastrado o conectados por accesorios.

**Lavabo Bidet / Washbasin Bidet**

ASEN0910N

ASEN0956N

ASEN0957N

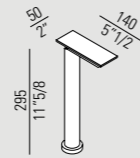
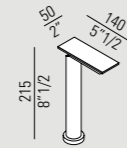
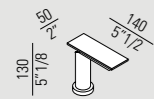

ASEN0962N

ASEN0912HSN

ASEN0914N

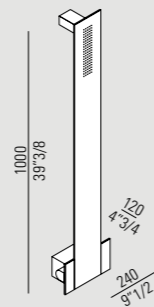
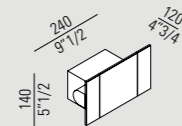
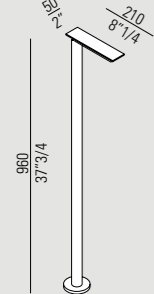

**Doccia / Shower**

**Vasca / Bathtub**

ASEN0973N

ASEN0911N

ASEN0912VSN

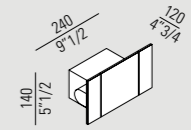
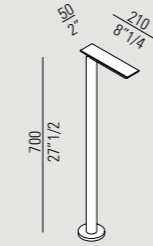
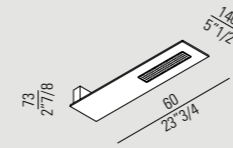

**Vasca Doccia / Bathtub Shower**

ASEN0913N

ASEN0958ON

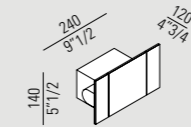
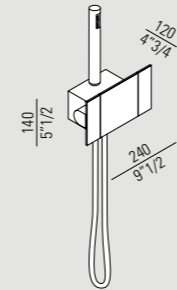

**Accessori / Accessories**

AKIT680A

AKIT0680B

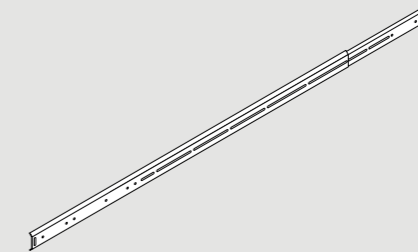
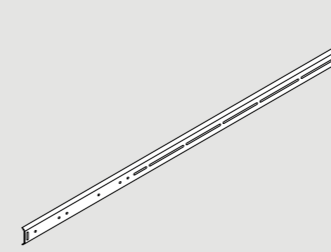

**Square** / 2005

Square è un progetto che cambia l'estetica della rubinetteria e la arricchisce di ulteriori funzioni, in tutte le tipologie di installazione: da incasso o esterne, per il lavabo, per la vasca o per la doccia. Square è realizzata in acciaio inox lucido o satinato.

Square is a range that changes the look of tap fittings and enhances them with additional functions, in all types of installation: recessed or surface-mounted, for washbasins, bathtubs or showers. Square is made in polished or satin-finish stainless steel.

Square, ein Design, das die Ästhetik der Armaturen abwandelt und mit weiteren Funktionen für jede Installation belegt: Unter- und Aufputz-Armaturen für Waschbecken, Badewanne und Dusche. Square ist aus glänzendem oder satiniertem Edelstahl.

Square est un projet qui modifie l'esthétique de la robinetterie et l'enrichit de fonctions supplémentaires, quels que soient les modèles choisis : encastrables ou externes, pour le lavabo, pour la baignoire ou pour la douche. Square est réalisée en acier inox poli ou satiné.

Square es un proyecto que cambia la estética de la grifería y la enriquece con otras funciones, en todos los tipos de instalación: encastrada o de superficie, para el lavabo, la bañera o la ducha. Square se fabrica en acero inoxidable brillo o satinado.



design Benedini Associati

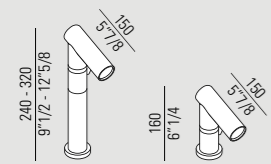

Finiture / Finishes



**Spoon XL**  
lavabo, washbasin,  
waschbecken, lavabo, lavabo  
→ Tools vol. 1

**369**  
accessori, accessories, accessoires,  
accessoires, accesorios  
→ Tools vol. 3

**Square** / 2005

Rubinetteria e dispenser per il sapone, integrati in un unico elemento dal sapore fortemente tecnologico, ma allo stesso tempo affascinante nel suo minimalismo, ammorbidito dalla nuova curvatura della bocca.

Taps and soap dispenser are integrated in a single, highly technological element which is fascinating in its minimalism, now softened by the new curved spout.

Armaturen und Seifenspender in einem gemeinsamen Element von starker Hightech-Optik, aber gleichzeitig faszinierend in seinem Minimalismus, der durch den neuen, gebogenen Auslauf gemildert wird.

Robinetterie et distributeur de savon, intégrés dans un seul élément avec une forte connotation technologique mais en même temps d'un minimalisme fascinant, adouci par la nouvelle courbe du bec.

Grifería y dispensador de jabón, integrados en un elemento único muy tecnológico pero también atractivo en su minimalismo, mitigado por la nueva curvatura de la boca.



design Benedini Associati

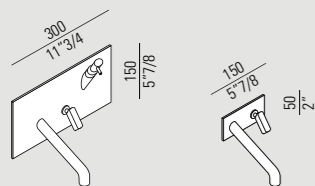

Finiture / Finishes



**Square** / 2005

La gamma Square è completata da nuovi gruppi composti dalla bocca di erogazione e dal comando collocabili entrambi sul piano ma tra loro indipendenti.

Le bocche sono fornite con tre differenti altezze per adattarsi alle varie tipologie di lavabi ed offrire una massima versatilità.

The Square range has expanded, with new units comprising a spout and control, both of which can be installed on the countertop, but are independent of each other.

The spouts come in three different heights to adapt to the various designs of washbasin and offer absolute versatility.

Die Linie Square wird durch neue Armaturen, bestehend aus Auslauf und Bedienhebel bereichert; beide können auf der Waschtischplatte, jedoch voneinander unabhängig, montiert werden.

Die Ausläufe sind in drei verschiedenen Höhen lieferbar, um sich unterschiedlichen Waschbecken anpassen zu können und maximale Flexibilität zu garantieren.

La gamme Square est enrichie de nouveaux groupes composés d'un bec et de la commande qui peuvent être montés tous deux sur le plan mais indépendants l'un de l'autre. Les becs sont disponibles en trois hauteurs pour s'adapter aux différentes typologies de lavabos et offrir une plus grande flexibilité.

La gama Square se completa con nuevos grupos compuestos por boca de erogación y mando, colocados independientemente sobre encimera. Las bocas están disponibles en tres alturas diferentes para adaptarse a diversos tipos de lavabos y ofrecer la máxima versatilidad.



design Benedini Associati

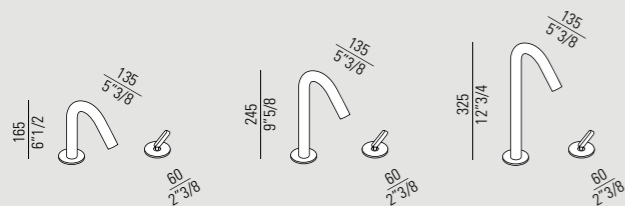

Finiture / Finishes





**Square** / 2005

L'estetica di Square è caratterizzata dal rigore e dalla tecnologica bellezza dell'acciaio inox, in versione satinata o lucida. Miscelatori monoforo con comando progressivo posizionabile a scelta indifferentemente a destra o a sinistra. Miscelatore e doccetta possono essere integrati in un unico elemento da terra, affiancabile a qualsiasi modello di vasca.

Square's appearance is based on clean lines, technology and the beauty of satin finish or polished stainless steel. Single-hole mixers with progressive control that can be positioned on either the right or left. Mixer tap and hand shower can be integrated in one single floor mounted element which can be used in combination with any bathtub.

Die Strenge und technologische Schönheit des Edelstahls charakterisieren die Ästhetik von Square, in satinierter und glänzender Ausführung. Einhandmischer mit progressiver Bedienung können beliebig rechts oder links angeordnet werden. Mischer und Handbrause können in einem einzigen, Standelement untergebracht werden, das für jedes Wannenmodell einsetzbar ist.

L'esthétique de Square est caractérisée par la rigueur et la beauté technologique de l'acier inox, poli ou satiné. Les mitigeurs monotrou à commande progressive peuvent être installés aussi bien à droite qu'à gauche. Le mitigeur et la douchette peuvent être intégrés dans un unique élément au sol, associable à n'importe quel modèle de baignoire.

La estética de Square se distingue por el rigor y la belleza tecnológica del acero inoxidable, en versión satinada o brillo. Mezcladores monomando con mando progresivo que pueden colocarse tanto a la derecha como a la izquierda. El mezclador y el duchador pueden integrarse en un elemento único apoyado en el suelo, que puede usarse con cualquier modelo de bañera.

**Deep** ○  
vasca, bathtub, badewanne,  
baignoire, bañera



design Benedini Associati

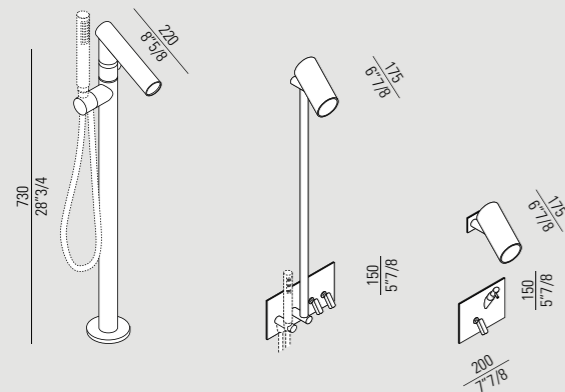

Finiture / Finishes



**Square** / 2005

Altre versioni per il gruppo Square per vasca con doccetta flessibile integrata: da parete oppure a bordo vasca, sempre con un design raffinatamente minimale.

Further options from the Square series for the bathtub with integrated flexible hand shower: wall- or bathtub-mounted, but always with the same sleek, minimal design.

Weitere Varianten von Wannenarmaturen Square mit integrierter Handbrause: Ob Unterputz oder am Wannenrand montiert, das Design ist stets von minimalistischer Finesse.

Autres versions pour le groupe Square pour baignoire avec douchette flexible intégrée : murale ou pour le bord de la baignoire, toujours avec un design raffiné et minimaliste.

Otras versiones del grupo Square para bañera con duchador flexible integrado: instalado a pared o sobre el borde de la bañera, siempre con un diseño refinadamente minimalista.

**Cartesio**

vasca, bathtub, badewanne,  
baignoire, bañera  
→ Tools vol. 2

design Benedini Associati

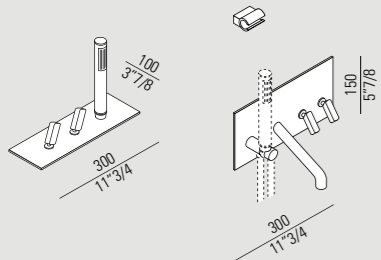

Finiture / Finishes



**Square** / 2005

Realizzata in acciaio inox lucido o satinato, la gamma Square è completata da un dispenser integrato per il sapone liquido e mensole da incasso.

Made in polished or satin-finish stainless steel, the Square range is completed with an integrated soap dispenser and recessed shelves.

Die Linie Square, hergestellt aus glänzendem oder satiniertem Edelstahl, wird durch einen integrierten Seifenspender und eingebaute Ablagen komplettiert.

Réalisée en acier inox poli ou satiné, la gamme Square est complétée par un distributeur intégré pour le savon liquide et par des étagères encastrables.

Fabricada en acero inoxidable brillo o satinado, la gama Square se completa con un dispensador integrado para el jabón líquido y repisas encastrables.

\* con cartuccia progressiva

\* with progressive cartridge

\* mit progressiver Kartusche

\* avec cartouche progressive

\* con cartucho progresivo

**Lavabo / Washbasin**

ARUB0930D\_ / ARUB0930C\_

ARUB0931D\_ / ARUB0931C\_

ARUB1009D\_ / ARUB1009C\_

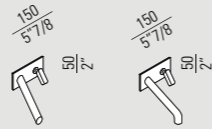
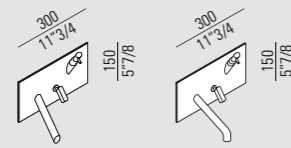
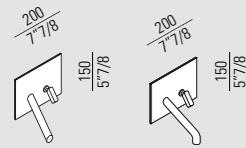

ARUB1023D\_ / ARUB1023C\_

ARUB1026D\_ / ARUB1026C\_

\* ARUB0950\_ / ARUB1021\_ / ARUB0951\_

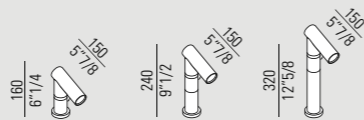
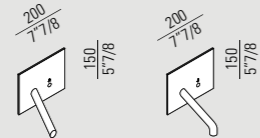
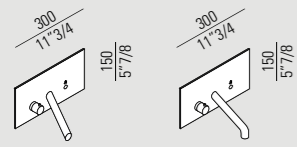

ARUB1006\_ / ARUB1007\_ / ARUB1008\_

\* ARUB1020\_

ARUB0939N\_

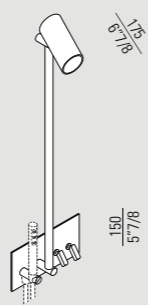
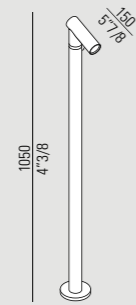
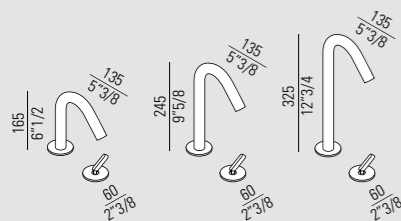

**Doccia / Shower**

ARUB0967\_

ARUB0941N\_

ARUB0944N\_

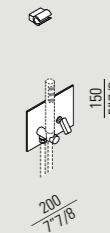
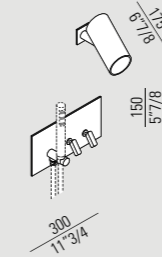
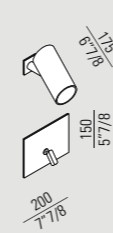

ARUB0945N\_

\* ARUB0959\_

\* ARUB1025N\_

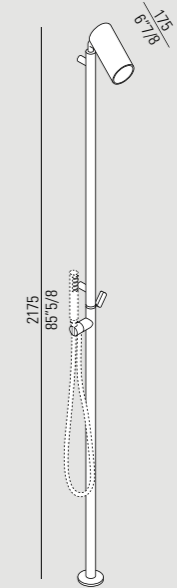
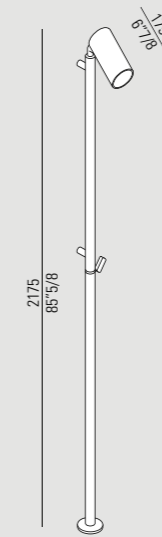

**Vasca / Bathtub**

ARUB0932ND\_

ARUB0932NC\_

ARUB0933ND\_

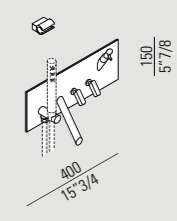
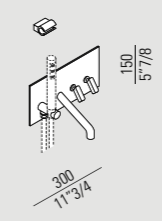
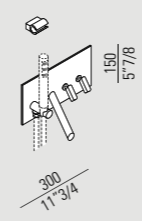

**Vasca / Bathtub**

ARUB0933NC\_

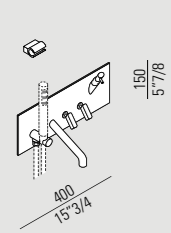

ARUB0961L\_

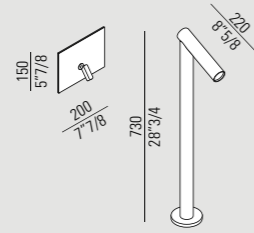

ARUB0934L\_

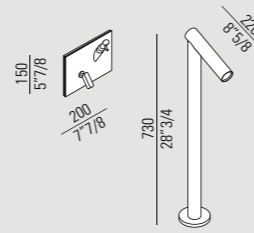

ARUB0935NL\_

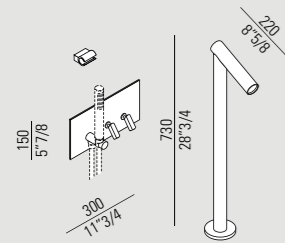

ARUB0936NL\_

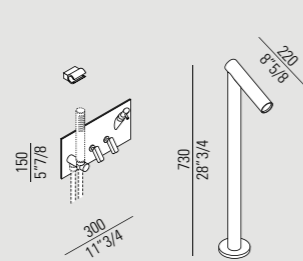

\* ARUB0952L\_

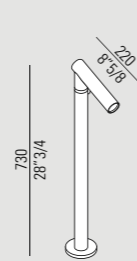

\* ARUB1024N\_

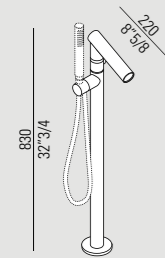

\* ARUB0960\_



**Mensole / Shelves**

AMEN0946\_

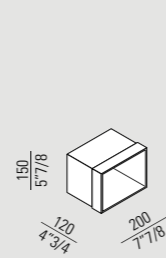

AMEN0947\_

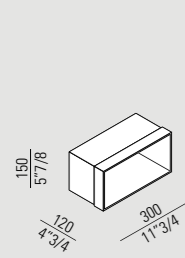

AMEN0948\_

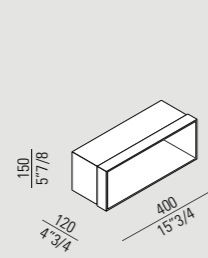

AMEN0949\_

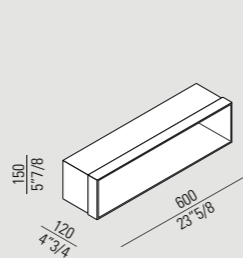

**Mensole / Shelves**

AMEN0950\_

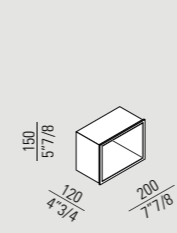

AMEN0951\_

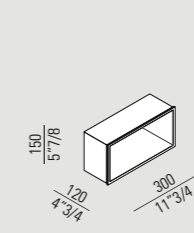

AMEN0952\_

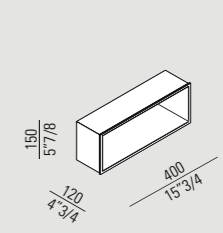

AMEN0953\_

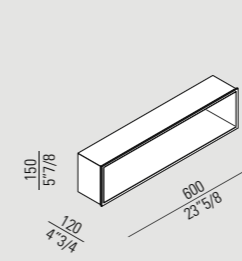

**Suite** / 2009

Forme fluide ed eleganti per la rubinetteria Suite con comando laterale, realizzata in ottone cromato proposta, per il lavabo, in versione a parete oppure su piano.

Elegant, flowing shapes distinguish Suite taps with their tilted handle, produced in chrome-plated brass, and available for washbasins in a wall- or top-mounted version.

Die Armaturen Suite mit seitlichem Bedienungshebel, zeichnen sich durch fließende, elegante Formen aus. Hergestellt aus verchromtem Messing, können die Waschbeckenarmaturen an der Wand oder auf der Ablage montiert werden.

Formes fluides et élégantes pour la robinetterie Suite avec commande latérale, réalisée en laiton chromé et proposée, pour le lavabo, dans la version murale ou sur plan.

La grifería Suite, se caracteriza por sus formas sencillas y elegantes y por su mando lateral. Fabricada en latón cromado, se usa para el lavabo y existe en dos versiones: a pared o sobre encimera.

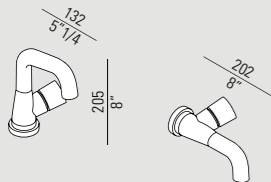

design Benedini Associati

**In-Out**

lavabo, washbasin,  
waschbecken, lavabo,  
lavabo  
→ Tools vol. 1

**Suite** / 2009

La rubinetteria Suite per vasca si presenta in due versioni: a parete, con tutte le funzioni in uno spazio ottimale, oppure a pavimento, per affiancare una vasca a centro stanza.

Suite bath taps come in two versions: wall-mounted, offering all the functions while optimising on space, or floor-mounted, for installation alongside a centrally-positioned bathtub.

Armaturen Suite für Badewanne gibt es in zwei Varianten: als Unterputzarmatur mit allen Funktionen auf kleinstem Raum oder freistehend für Badewannen in Raummitte.

La robinetterie Suite pour baignoire se présente en deux versions : murale, avec toutes les fonctions réunies dans un espace optimal, ou au sol, à placer à côté d'une baignoire en îlot.

La grifería Suite para bañera se presenta en dos versiones: a pared, con todas sus funciones en un espacio mínimo, o a suelo, ideal para una bañera en isla.

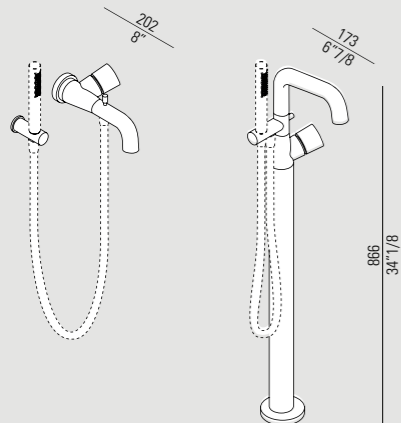

design Benedini Associati

**Viceversa**

vasca, bathtub, badewanne,  
baignoire, bañera  
→ Tools vol. 2

**Suite** / 2009

Caratterizzata dal pratico comando collocato sul lato, la rubinetteria Suite è realizzata in ottone cromato.

Featuring a handy lateral control, Suite taps are made in chrome-plated brass.

Die Armaturen Suite, die im praktischen, seitlichen Bedienungshebel ihr charakteristisches Merkmal haben, sind aus verchromtem Messing hergestellt.

Caractérisée par une commande pratique placée sur le côté, la robinetterie Suite est réalisée en laiton chromé.

La grifería Suite caracterizada por su práctico mando lateral, se fabrica en latón cromado.

**Lavabo / Washbasin**

ARUB1100S

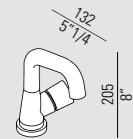

ARUB1101S

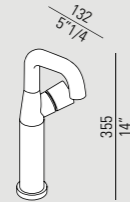

ARUB1102S

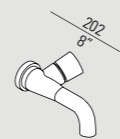

**bidet / bidet**

ARUB1103S

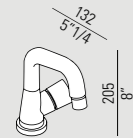

**Doccia / Shower**

ARUB1104S



ARUB1105S



ARUB1106S

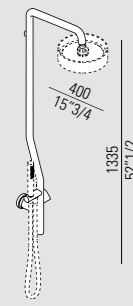

ARUB1107S

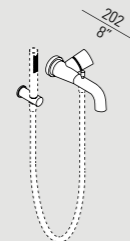

ARUB1108S

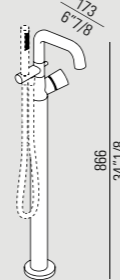

**Al dente** / 2003

La trasposizione di un accessorio della cucina, il colino, guida il disegno del soffione. Il diffusore dell'acqua in polipropilene arancio o verde è semplicemente appoggiato su un canestro realizzato in acciaio inox; lo stesso principio determina la forma del portasapone.

The design of the shower head is based on that of a kitchen accessory, the colander, transposed to the bathroom. The water diffuser in orange or green polypropylene simply rests on a stainless steel hoop; the same principle is used for the soap holder.

Die Abwandlung eines Küchenutensils, des Siebs, bestimmt das Design dieses Objektes. Der Brausekopf aus orangem oder grünem Polypropylen wird einfach in eine Halterung aus rostfreiem Stahl eingesetzt. Das gleiche Prinzip kommt für die Seifenschale zur Anwendung.

Transposer un accessoire de la cuisine, comme la passette, dans la salle de bains est à l'origine du design de la douche de tête. Le diffuseur de l'eau en polypropylène orange ou vert est tout simplement enfilé dans un anneau en acier inox; ce même principe est à la base de la forme du porte-savon.

El diseño de la alcachofa se basa en un accesorio usado en la cocina: el colador. El difusor del agua, fabricado en polipropileno naranja o verde, está apoyado simplemente en un cesto de acero inoxidable; el mismo diseño se ha utilizado en la jabonera.

— selezione, *selection*  
Young Design, 2004

design Davide Borin, Nicola Gibertini,  
Mattia Vittori

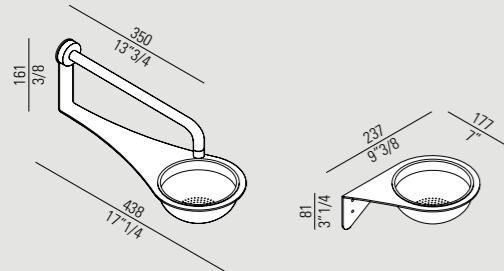

.CRUB0998\_

.CRUB0999\_

Finiture / Finishes



**Fez**  
rubinetteria, *taps, armatur,*  
*robinetterie, griferia*  
→ Tools vol. 3





**ARUB400 / 401** / 2011

Elementi che permettono di installare l'erogatore della doccia in una posizione diversa dalla presa d'acqua sul soffitto o sulla parete, ottimizzando lo spazio a disposizione.

Elements that enable you to install the shower head in a different position from the water outlet on the ceiling or wall, to make optimum use of available space.

Diese Elemente ermöglichen die Installation der Kopfbrause getrennt von der Wasserzuleitung an der Decke oder Wand, um den verfügbaren Raum optimal zu nutzen.

Éléments qui permettent d'installer la tête de la douche dans une position différente de la prise d'eau au plafond ou sur le mur, en optimisant l'espace à disposition.

Elementos que permiten instalar la alcachofa en una posición diferente respecto a la toma de agua en el techo o en la pared, optimizando el espacio.

**Cooper**  
doccia, shower, dusche,  
douche, ducha  
→ Tools vol. 2



design Benedini Associati

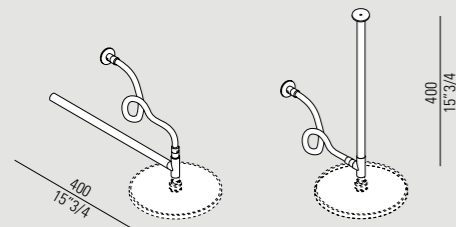

ARUB400

ARUB401

**Hydro** / 2006

Hydro offre due soluzioni: l'idroscopino® per la pulizia del WC con getto ad effetto laser, e l'idrobidet con getto morbido per l'igiene personale. La doccetta è in materiale plastico cromato o nei colori arancio o verde, il flessibile in PVC grigio e il supporto a parete in ottone cromato lucido.

Hydro offers two solutions: hydrobrush (idroscopino®) for cleaning the WC with laser effect jet, and hydrobidet with soft water gush for personal Hygiene. The hand shower is in orange, green or chrome-plated plastic, the hose is in grey PVC, and the wall bracket in polished chrome-plated brass.

Hydro gibt es für zwei Anwendungsbereiche: als „Idroscopino®“ mit laserartigem Wasserstrahl zur Toilettenreinigung und als Hydrobidet mit weichem Wasserstrahl für die persönliche Hygiene. Der Kopf ist aus verchromtem Kunststoff oder in den Farben orange oder grün, der Schlauch aus grauem PVC und die Wandhalterung aus glänzendem, verchromtem Messing.

Hydro offre deux solutions: l'idroscopino® pour le nettoyage du WC avec jet d'eau à effet laser, et hydrobidet avec jet souple pour hygiène personnelle. La douchette est en plastique chromé et existe en orange ou vert, le flexible est en PVC gris et le support mural en laiton chromé poli.

Hydro ofrece dos soluciones: la escobilla hídrica para limpiar el inodoro con un chorro muy fino de efecto láser, y el hidrobidet con chorro suave para la higiene personal. El duchador es de plástico cromado, de color naranja o verde; el flexible de PVC es gris y el soporte mural de latón cromado brillo.

design Giulio Gianurco,  
UT Agape

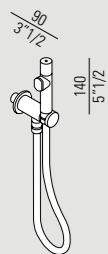

ARUB0918\_

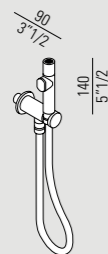

ARUB0916\_

Finiture / Finishes



**750**

sanitari, sanitary ware,  
Sanitärkeramik, sanitaires,  
sanitarios

→ Tools vol. 1

**Kaa** / 2003

L'elasticità della doccia e del soffione, realizzati con gomma silicónica anallergica, trasmettono la morbidezza del massaggio per la cura della persona. In arancio, verde e grigio danno colore alla rubinetteria della doccia.

The flexible hand shower and fixed shower head, made of hypo-allergenic silicone rubber, offer a gentle massage for the body. In orange, green and grey, they bring colour to the shower fittings.

Die Elastizität von Handbrause und Brausekopf aus antiallergenem Silikongummi vermitteln dem Körper das Gefühl einer weichen Massage. In orange, grün und grau verleihen sie der Duscharmatur Farbe.

L'élasticité de la douchette et de la douche de tête, réalisées en caoutchouc de silicone anallergique transmettent toute la douceur d'un massage corporel bienfaisant. En orange, vert ou gris, ils égayent la robinetterie de la douche.

La elasticidad del duchador y de la alcachofa, realizados en goma silicónica antialérgica, transmiten toda la suavidad de un masaje. El naranja, el verde y el gris dan color a esta grifería.

– premio, *award*  
Elle Decor International  
Design Awards, 2005



– premio, *award*  
Design Plus Material  
Vision, 2005

DESIGN **PLUS**

– premio, *award* German  
Design, 2007



○ **Fez**  
rubinetteria, taps, armatur,  
robinetterie, grifería  
→ Tools vol. 3

design Giulio Gianturco

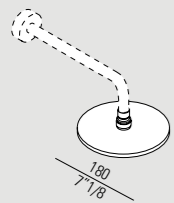

.CRUB0913\_

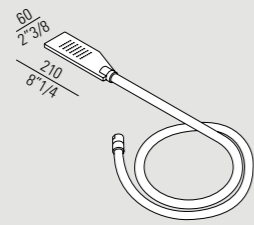

.CRUB0914\_

Finiture / Finishes



**Doccette e soffioni**

Soffioni, doccette e supporti in varie dimensioni da inserire nei gruppi doccia e vasca delle rubinetterie di produzione Agape.

Shower heads, hand-held showers and supports for shower and bathtub taps manufactured by Agape.

Kopfbrausen, Handbrausen und die zugehörigen Halterungen in verschiedenen Massen zur Komplettierung von Dusch- und Badewannenarmaturen unserer Produktion.

Douches de tête, douchettes et supports en différentes mesures à utiliser avec les groupes douche et baignoire des robinets de production Agape.

Alcachofas, duchadores y soportes en varias dimensiones, que completan las griferías de ducha y bañera de Agape.

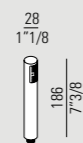
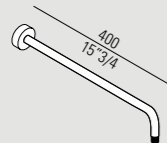
**369**

accessori, *accessories*, *accessoires*,  
*accessoires*, *acessorios*  
→ Tools vol. 3



## Doccette e soffioni

Soffioni, doccette e supporti realizzati in vari materiali e finiture.

Shower heads, hand-held showers and supports in several materials and finishes.

Kopfbrausen, Handbrausen und die zugehörigen Halterungen in verschiedenen Materialien und Ausführungen.

Douches de tête, douchettes et supports réalisés en différents matériaux et finitions.

Alcachofas, duchadores y soportes realizados en varios materiales y acabados.

### Soffioni / Shower heads

**.MET0225R\_**  
Ottone / Brass / Messing / Lation / Latón



**.CRUB0915\_**  
Ottone / Brass / Messing / Lation / Latón



**.CRUB1100R / .CRUB1101R**  
ABS

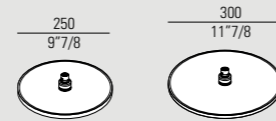

### Supporti / Supports

**.CRUB0903\_ / .CRUB0923\_**  
Ottone / Brass / Messing / Lation / Latón

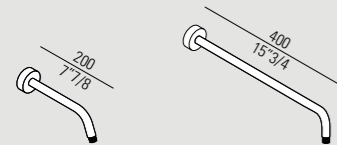

**.CRUB0924\_ / .CRUB0925\_**  
Ottone / Brass / Messing / Lation / Latón

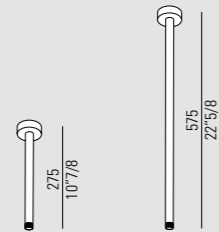

### Doccette / Handheld showers

**.MET0169R\_**  
Ottone / Brass / Messing / Lation / Latón

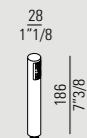

**.MET0268R\_**  
ABS

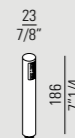

**.CRUB1102R**  
ABS



Accanto ai protagonisti dell'ambiente bagno, anche gli accessori Agape hanno un ruolo importante: rendere la vita più bella e più comoda, grazie al loro stile ed alla loro funzionalità.

Alongside the key fixtures in the bathroom, Agape accessories have an important supporting role: to make life simpler and more pleasant with their style and functionality.

Neben den Protagonisten des Badezimmers spielen auch die Accessoires von Agape eine wichtige Rolle: das Leben schöner und bequemer zu gestalten, dank ihres Stils und ihrer Funktionalität.

Aux côtés des protagonistes de la salle de bains, les accessoires Agape jouent, eux aussi, un rôle important: rendre la vie plus belle et plus confortable, grâce à leur style et à leur fonctionnalité.

Junto a los protagonistas del cuarto de baño, también los accesorios Agape asumen una función importante: facilitar la vida y hacerla más cómoda gracias a su estilo y funcionalidad.

Agape tools 3:  
**Accessori/Accessories/Accessoires/Accessorios**  
**/Accessoires/Accesorios** → pag 074.

**pag**

074, 076	Bucatini
078, 080	Mach
082, 084, 086	Memory
088, 090	O
092, 094	O.L.C
096, 098	Porto
100, 102, 104	Sen
106	Surf
108, 110	369

**Bucatini** / 1997

Giovani e divertenti, gli accessori del programma Bucatini sono costituiti da un cavetto in acciaio inox rivestito in materiale plastico trasparente, utilizzato come portaserviette o come supporto per vaschette, contenitori, accessori e specchi.

The youthful and amusing accessories in the Bucatini range consist of a stainless steel cable sheathed in a transparent plastic material, used as a towel holder or support for trays, containers, accessories and mirrors.

Jung und lustig sind die Accessoires des Programms Bucatini, die aus einem Edelstahlseil mit transparenter Plastikhülle bestehen, das als Handtuchhalter oder Halterung für Behälter, Ablagen, Accessoires und Spiegel fungiert.

Jeunes et amusants, les accessoires du programme Bucatini sont réalisés avec un câble en acier inox revêtu d'une gaine en plastique transparent, servant de porteserviettes ou de support pour bacs, porte-objets, accessoires et miroirs.

Juveniles y divertidos, los accesorios del programa Bucatini tienen por un cable de acero inoxidable revestido con material plástico transparente: se usan como toallero o soporte para bandejas, portaobjetos, accesorios y espejos.



design Fabio Bortolani, Ermanno Righi

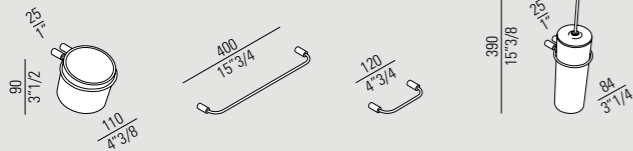

**Bucatini** / 1997

Accessori realizzati con un cavetto in acciaio ricoperto da materiale plastico trasparente che ha anche funzione di supporto per contenitori in ceramica bianca.

Accessories made from stainless steel cable sheathed in transparent plastic, also used as supports for white ceramic containers.

Accessoires aus einem mit transparentem PVC ummantelten Kabel, das auch als Halterung für Behälter aus weißer Keramik fungiert.

Accessoires réalisés avec un câble en acier revêtu d'une gaine en plastique transparent servant également à soutenir les objets de rangement en céramique blanche.

Accesorios realizados con un pequeño cable de acero recubierto con material plástico transparente cuya función es también la de sostener los contenedores de cerámica blanca.

**Accessori / Accessoires****ABUC0160 / ABUC0160S**

Porta sapone / Soap holder / Seifenschale / Porte-savon / Porta jabón

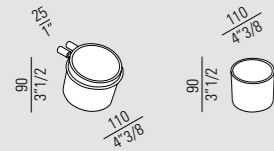
**ABUC0161 / ABUC0161S**

Porta spazzolini / Toothbrush holder / Zahnbürstenhalter / Porte-brosses à dents / Porta cepillos de dientes

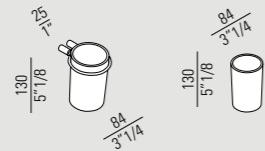
**ABUC0179**

Supporto per dispenser / Support for dispenser / Halterung für Seifenspender / Support pour distributeur savon liquide / Soporte para dispensador de jabón líquido

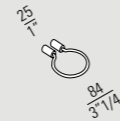
**ABUC0180**

Mensola / Shelf / Spiegelablage / Tablette / Repisa

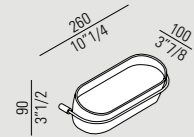
**ABUC0182 / ABUC0182S**

Contenitore / Container / Behälter / Récipient / Contenedor

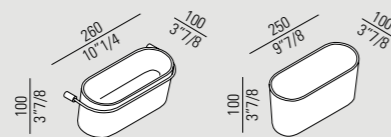
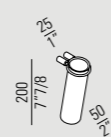
**ABUC0175****ABUC0165**

Porta salviette / Towel holder / Handtuchhalter / Porte-serviettes / Toallero

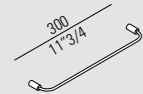
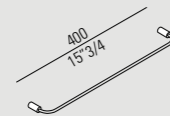
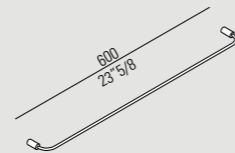
**ABUC0166****ABUC0167****ABUC0168****ABUC0179****ABUC0171**

Porta abiti / Clothes hanger / Kleiderhaken / Patères / Perchero

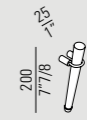
**ABUC0170****ABUC0172 / ABUC0174**

Porta rotolo / Toilet roll holder / Toilettenpapierhalter / Porte-rouleau papier toilette / Portarollo

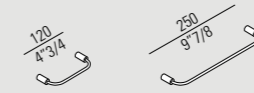
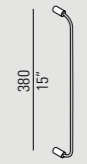
**ABUC0173****ABUC0176**

Porta riviste / Magazine holder / Zeitungshalter / Porte-revues / Porta revistas

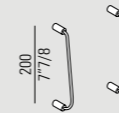
**ABUC0175**

Porta scopino / Toilet brush holder / Toilettenbürste / Porte-balai WC / Porta escobilla

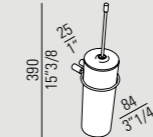



**Mach** /2000

Acciaio inox lucido o satinato e Solid surface bianco per Mach, il programma di accessori contraddistinto da uno stile geometrico e razionale. Nell'ideazione della serie l'attenzione è stata rivolta principalmente alle necessità funzionali degli spazi dedicati alla collettività quali ristoranti, bar e hotel ma trova una facile collocazione anche all'interno degli spazi dedicati al bagno domestico.

Polished or satin-finish stainless steel and white Solid surface for Mach, a range of accessories characterised by their geometric and rational style. When creating this range, the designer concentrated mainly on the practical needs of public spaces such as restaurants, bars and hotels, but it fits equally well into the home bathroom.

Glänzender oder satiniertes Edelstahl und weißes Solid surface für Mach, das Programm der Accessoires im geometrischen und rationalen Stil. Beim Entwurf dieser Serie galt das Hauptaugenmerk den funktionellen Ansprüchen von Sanitäreinrichtungen in Restaurants, Bars und Hotels, sie kann aber ebenso gut im häuslichen Bad eingesetzt werden.

Acier inox poli ou satiné et Solid surface pour Mach, le programme d'accessoires doté d'un style géométrique et rationnel. Lors de la conception de la série, l'attention s'est portée principalement sur les nécessités fonctionnelles des espaces destinés à la collectivité, tels que les restaurants, les bars et les hôtels, mais la série trouve aussi sa place dans les salles de bains de nos maisons.

Acero inoxidable brillo o satinado y material Solid surface blanco para Mach, la serie de accesorios que se diferencia por un estilo geométrico y racional. Para diseñar esta serie, se basaron principalmente en las necesidades de espacios públicos como restaurantes, bares y hoteles, aunque ubica también idóneamente en espacios domésticos.



design Konstantin Grcic

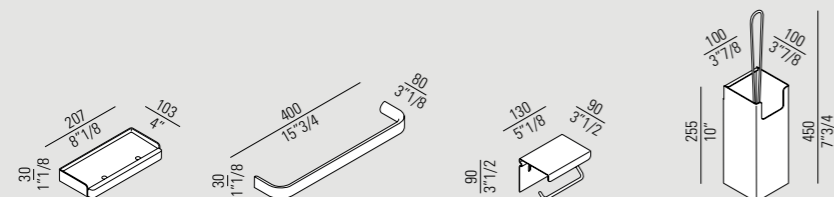

Finiture / Finishes



**Mach** / 2000

Accessori realizzati in acciaio inox con finitura lucida o satinata. Mensole in Solid surface bianco.

Stainless steel accessories with polished or satin finish. Shelves in white Solid surface.

Accessoires aus glänzendem oder satiniertem Edelstahl. Ablagen aus weißem Solid surface.

Accessoires en acier inox poli ou satiné. Étagères en Solid surface blanc.

Accesorios de acero inoxidable con acabado brillo o satinado. Estantes de Solid surface blanco.

**Accessori / Accessoires**

**AMAC0654**  
Porta sapone / Soap holder / Seifenschale / Porte-savon / Porta jabón

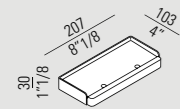

**AMAC0670**  
Porta sapone - spazzolini / Soap - Toothbrush holder / Seifenschale Zahnbürstenhalter / Porte savon - brosses à dents / Porta jabón - cepillos de dientes

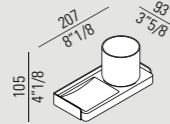

**AMAC0657**  
Dispenser per sapone / Liquid soap dispenser / Seifenspender / Distributeur de savon liquide / Dispensador de jabón líquido

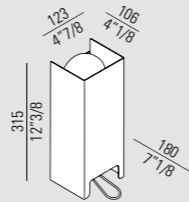

**AMAC0666**  
Porta salviette / Towel holder / Handtuchhalter / Porte-serviettes / Toallero

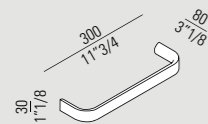

**AMAC0667**

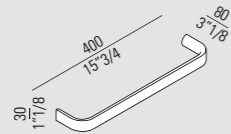

**AMAC0668**

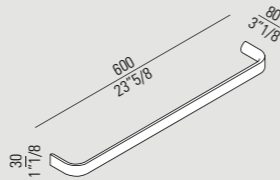

**AMAC0663**  
Dispenser salviette / Paper towel dispenser / Papierhandtuchspender / Distributeur serviettes / Dispensador de servilletas

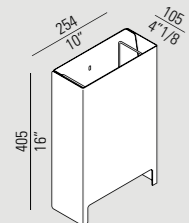

**AMAC0658**  
Porta abiti / Clothes hanger / Kleiderhaken / Patères / Perchero



**AMAC0659 / AMAC0660**  
Porta rotolo / Toilet roll holder / Toilettenpapierhalter / Porte-rouleau papier toilette / Portarollo

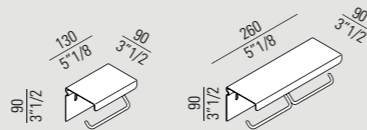

**AMAC0665**  
Porta scopino / Toilet brush holder / Toilettenbürste / Porte-balai WC / Porta escobilla

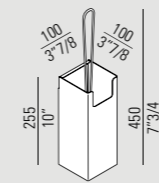

**AMAC0661**  
Porta sacchetti igienici / Sanitary bags dispenser / Sanitärbeutelspender / Porte-sachets hygiéniques / Porta bolsas higiénicas

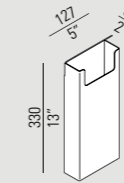

**AMAC0662**  
Porta "kleenex" / Tissue box holder / Kleenextuchspender / Distributeur mouchoirs papier / Porta "kleenex"

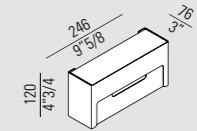

**AMAC0664**  
Gettacarta / Wastepaper basket / Papierkorb / Corbeille à papier / Papelera

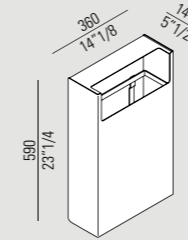

**Memory** / 2010

Una proposta completa di accessori per la sala da bagno, ispirati alla cultura del design del XX secolo, rivisitata alla luce della contemporaneità.

A complete range of accessories for the bathroom, inspired by Twentieth-century design culture, revisited in a contemporary light.

Eine komplette Serie von Accessoires für das Badezimmer, die sich von der Designkultur des 20. Jahrhunderts inspirieren lässt und im zeitgemäßen Stil neu interpretiert wird.

Une proposition complète d'accessoires pour la salle de bains s'inspirant de la culture du design du XXe siècle, réinterprétée dans un style plus contemporain.

Una gama completa de accesorios para el cuarto de baño, inspirados en la cultura del diseño del siglo XX, revisitada con una visión contemporánea.

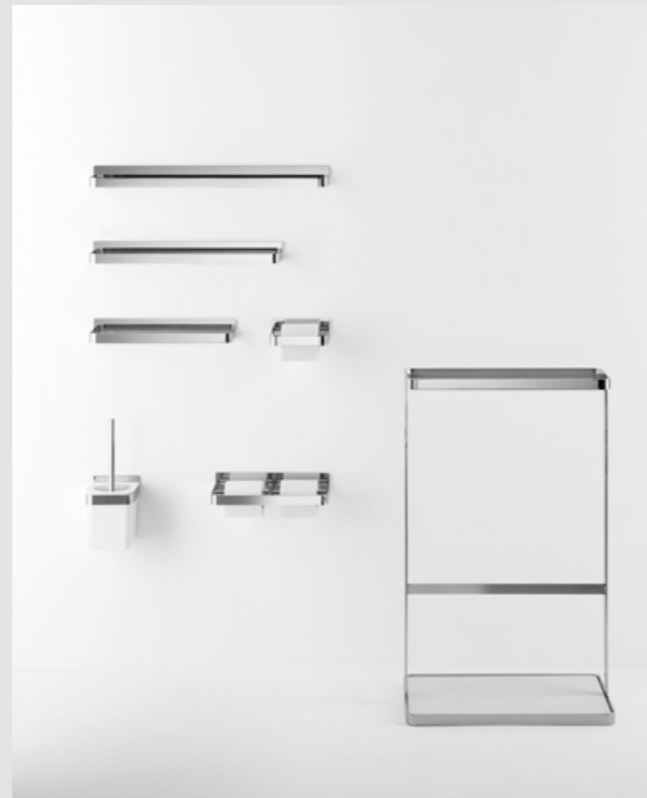

design Benedini Associati

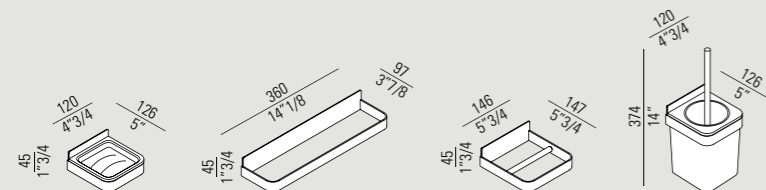

**Memory** / 2010 – 2012

Comodo e raffinato  
scalda salviette  
autoregolante,  
realizzato in acciaio  
cromato lucido o  
verniciato in bianco o  
nero. Viene fissato alla  
parete con un sistema  
invisibile.

An elegant and  
convenient self-  
regulating heated  
towel rail in steel with  
a polished chrome-  
plated or black and  
white painted finish.  
It is attached to  
the wall through an  
invisible system.

Praktisch und raffiniert  
die selbstregelnden  
Handtuchrockner,  
hergestellt aus Stahl,  
entweder verchromt  
glänzend, oder weiß  
oder schwarz lackiert.  
Wird an der Wand mit  
unsichtbaren Befesti-  
gungselemen ten  
fixiert.

Chauffe-serviettes  
pratique et raffiné avec  
autorégulation, réalisé  
en acier chromé poli  
ou laqué en blanc  
et noir. Il est fixé au  
mur par un système  
invisible.

Toallero calentador  
con autorregulación,  
cómodo y refinado,  
construido en acero  
cromado brillo o  
lacado blanco o negro.  
Se fija a pared con un  
sistema invisible.

400W – 230V  
IP 67 cl 2

design Benedini Associati

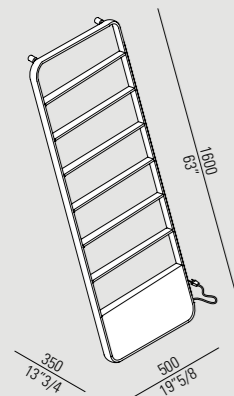

**Memory**  
accessori, accessories,  
accessoires, accessoires,  
acessorios  
→ Tools vol. 3



**Memory**  
sanitari, sanitary ware,  
sanitärkeramik, sanitaires,  
sanitarios  
→ Tools vol. 1



Finiture / Finishes



**Memory** / 2010

Accessori realizzati in acciaio inox lucido, con fissaggi non visibili, completati da elementi in Cristalplant®biobased bianco.

Polished stainless steel accessories, with hidden fixings, completed with white Cristalplant®biobased elements.

Accessoires aus glänzendem Edelstahl mit unsichtbarer Wandbefestigung, komplettiert durch Elemente aus weißem Cristalplant®biobased.

Accessoires réalisés en acier inox poli, avec fixations invisibles, dotés d'éléments en Cristalplant®biobased blanc.

Accesorios de acero inoxidable brillo, con fijaciones invisibles; se completan con elementos de Cristalplant®biobased blanco.

**Accessori / Accessoires**

**AMEM856A**  
Mensola / Shelf / Spiegelablage / Tablette / Repis

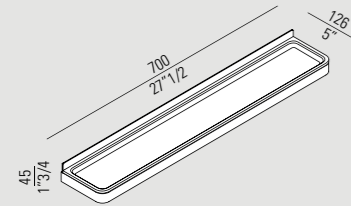

**AMEM852A**

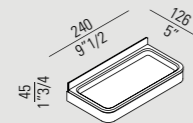

**AMEM851A**

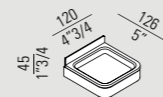

**AMEM854A**  
Porta sapone / Soap holder / Seifenschale / Porte-savon / Porta jabón

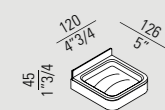

**AMEM853A**  
Porta spazzolini / Toothbrush holder / Zahnbürstenhalter / Porte-brosses à dents / Porta cepillos de dientes

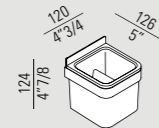

**AMEM857A**  
Porta salviette / Towel holder / Handtuchhalter / Porte-serviettes / Toallero

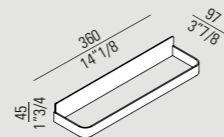

**AMEM858A**

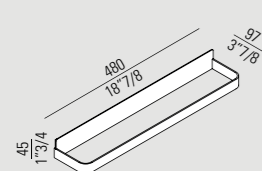

**AMEM859A**

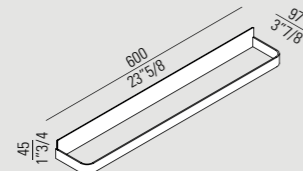

**AMEM862A**

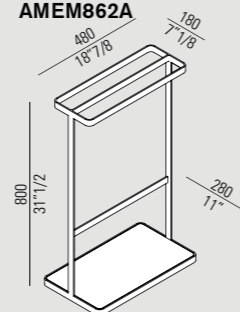

**AMEM864A**  
Porta abiti / Clothes hanger / Kleiderhaken / Patères / Perchero



**AMEM860A / AMEM861A**  
Porta rotolo / Toilet roll holder / Toilettenpapierhalter / Porte-rouleau papier toilette / Portarollo

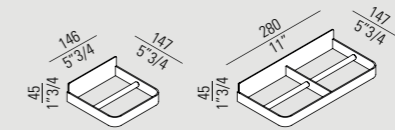

**AMEM855A**  
Porta scopino / Toilet brush holder / Toilettenbürste / Porte-balai WC / Porta escobilla

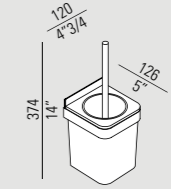

**AMEM8871\_**  
Scalda salviette / Heated towel rail / Handtuchtrockner / Chauffe serviettes / Calentador de toallas

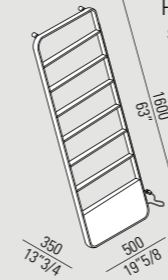

O / 1994

Un tratto lineare e gradevole disegna le forme degli accessori della serie O, in tondo di acciaio inox.

The Serie O range of accessories, made of stainless steel rods, features an appealing linear design.

Eine lineare und angenehme Kontur zeichnet die Formen der Accessoires der Serie O aus; hergestellt aus Edelstahl.

Un trait linéaire et agréable dessine les formes des accessoires de la série O, en rond d'acier inox.

Un rasgo lineal pero agradable caracteriza a los accesorios de la serie O, en tubo redonda de acero inoxidable.



design Marco Ferreri

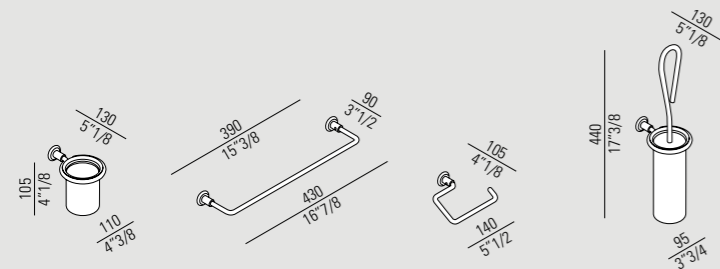

O / 1994

Accessori realizzati  
in acciaio inox con  
finitura lucida.

Stainless steel  
accessories with  
polished finish.

Accessoires aus  
glänzendem Edelstahl.

Accessoires en acier  
inox poli.

Accesorios de acero  
inoxidable con  
acabado brillo.

Accessori / Accessoires

**AFER0890A**

Mensola / Shelf / Ablage / Tablette  
/ Repisa

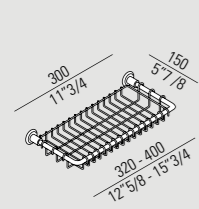

**AFER0891A**

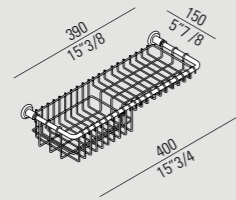

**AFER0854A**

Porta sapone / Soap holder / Seifenschale  
/ Porte-savon / Porta jabón

**AFER0855/S / AFER0880A**

Porta spazzolini / Toothbrush holder /  
Zahnbürstenhalter / Porte-brosses à dents  
/ Porta cepillos de dientes

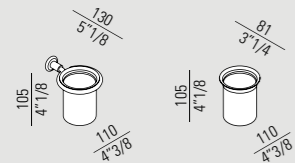

**AFER0858A**

Porta salviette / Towel holder /  
Handtuchhalter / Porte-serviettes  
/ Toallero

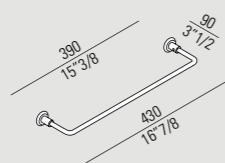

**AFER0859A**

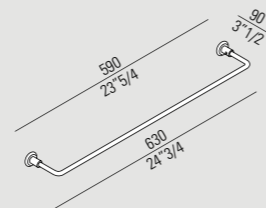

**AFER0863A**



**AFER0865A**

Porta abiti / Clothes hanger / Kleiderhaken /  
Patères / Perchero



**AFER0866A**



**AFER0867A**

Porta rotolo / Toilet roll holder /  
Toilettenpapierhalter / Porte-rouleau  
papier toilette / Portarollo

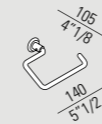

**AFER0869A**

Porta scopino / Toilet brush holder /  
Toilettenbürste / Porte-balai WC  
/ Porta escobilla

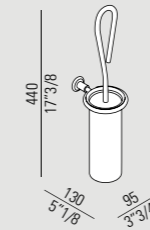

**O.L.C.** / 1988

Forme classiche e brillanti per il programma di accessori O.L.C. in ottone lucido e acciaio inox.

Classic and original shapes for the O.L.C. range of accessories in polished brass and stainless steel.

Klassische und brillante Formen für die Accessoires der Serie O.L.C. aus glänzendem Messing oder Edelstahl.

Des formes classiques et brillantes pour le programme d'accessoires O.L.C. en laiton poli et acier inox.

Formas clásicas y brillantes para el programa de accesorios O.L.C. en latón brillo y acero inoxidable.

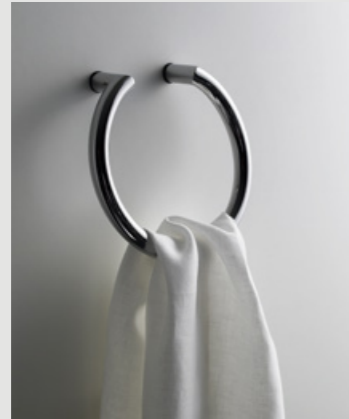

design Benedini Associati

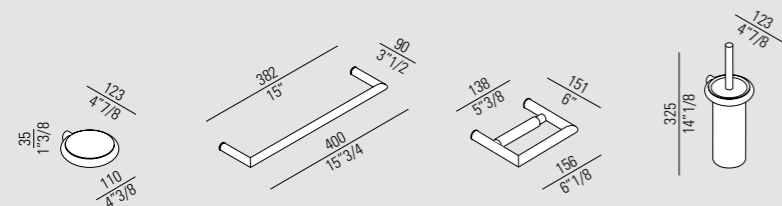



**O.L.C.** / 1988

Accessori realizzati in ottone cromato. Contenitori in acciaio inox lucido.

Accessories made of chromed brass. Containers in polished stainless steel.

Accessoires aus verchromtem Messing. Behälter aus glänzendem Edelstahl.

Accessoires en laiton chromé. Récipients en acier inox poli.

Accesorios de latón cromado. Contenedores de acero inoxidable brillo.

**Accessori / Accessoires**

**AOLC0836S**  
Porta sapone / Soap holder / Seifenschale / Porte-savon / Porta jabón

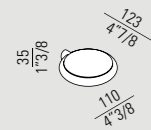

**AOLC0837S**  
Porta spazzolini / Toothbrush holder / Zahnbürstenhalter / Porte-brosses à dents / Porta cepillos de dientes

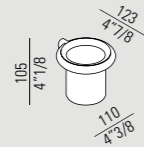

**AOLC0833S**  
Porta salviette / Towel holder / Handtuchhalter / Porte-serviettes / Toallero

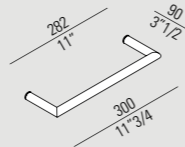

**AOLC0815S**

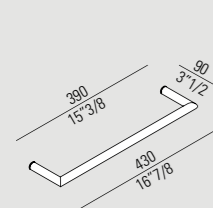

**AOLC0816S**

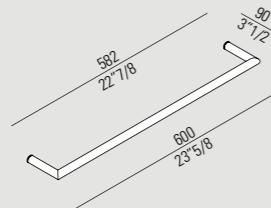

**AOLC0817S**



**AOLC0881S**

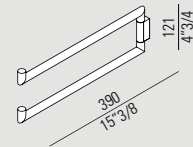

**AOLC0840S**

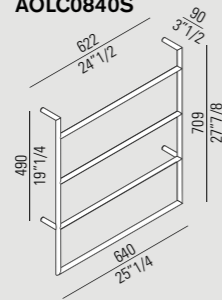

**AOLC0818S**

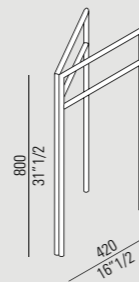

**AOLC0841S**  
Porta abiti / Clothes hanger / Kleiderhaken / Patères / Perchero



**AOLC0844S**  
Porta rotolo / Toilet roll holder / Toilettenpapierhalter / Porte-rouleau papier toilette / Portarollo

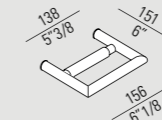

**AOLC0845S**

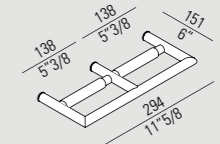

**AOLC0829S**

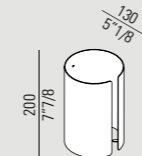

**AOLC0846S**  
Porta scopino / Toilet brush holder / Toilettenbürste / Porte-balai WC / Porta escobilla

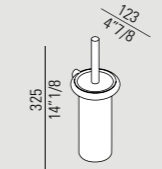

**AOLC0847S**

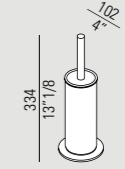

**AOLC0828S**  
Porta riviste / Magazine holder / Zeitungshalter / Porte-revues / Porta revistas

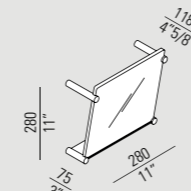

**AOLC0827S**  
Sgabello / Stool / Hocker / Tabouret / Banqueta

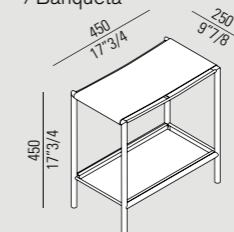

**Porto** / 2000

Un posto per ogni cosa, una soluzione per ogni necessità: Porto offre un programma completo di accessori da appoggio realizzati in acciaio inox e Solid surface bianco. Gli accessori da parete Porto risolvono le più diverse esigenze della vita in bagno, con coerenza stilistica ed elegante razionalità.

A place for everything and a solution for every need: Porto is a complete range of storage accessories in stainless steel and white Solid surface. Porto wall-mounted accessories meet a wide variety of bathroom requirements, with stylistic consistency and elegant logic.

Ein Platz für jedes Objekt, eine Lösung für jedes Bedürfnis: Porto bietet ein komplettes Programm von Accessoires aus Edelstahl und weißem Solid surface. Die hängenden Accessoires der Serie Porto lösen die verschiedensten Bedürfnisse des Lebens im Bad mit stilistischer Kohärenz und eleganter Rationalität.

Une place pour chaque chose, une solution pour chaque problème: Porto offre un programme complet d'accessoires à poser réalisés en acier inox et Solid surface blanc. Les accessoires à fixation murale Porto répondent, avec une cohérence stylistique et une élégance rationnelle hors pair, aux exigences les plus diverses qui peuvent naître dans une salle de bains.

Un lugar para cada cosa, una solución para cada necesidad: Porto ofrece un programa completo de accesorios de apoyo fabricados en acero inoxidable y Solid surface blanco. Los elementos a pared resuelven las más variadas exigencias de la vida en el baño, con coherencia estilística y elegante racionalidad.



design Claudio La Viola

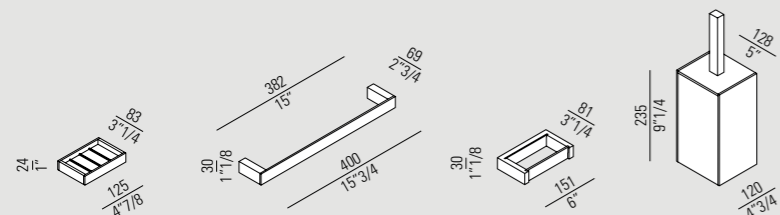

**Porto** / 2000

Accessori realizzati in acciaio inox con finitura Scotch Brite con bordi lucidi e Solid surface bianco.

Stainless steel accessories with Scotch Brite finish with polished edges and white Solid surface.

Accessoires in Edelstahl in der Ausführung Scotch Brite mit glänzenden Rändern und weißem Solid surface.

Accessoires en acier inox et finition Scotch brite avec chants polis et Solid surface blanc.

Accesorios de acero inoxidable con acabado Scotch Brite, con bordes brillantes y Solid surface blanco.

**Accessori / Accessoires**

**APOR0575**  
Mensola / Shelf / Spiegelablage / Tablette / Repisa

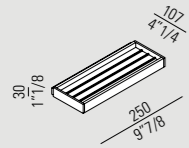

**APOR0573**  
Porta sapone / Soap holder / Seifenschale / Porte-savon / Porta jabón

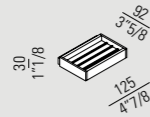

**APOR0571**

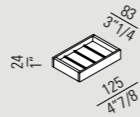

**APOR0574**  
Porta spazzolini / Toothbrush holder / Zahnbürstenhalter / Porte-brosses à dents / Porta cepillos de dientes

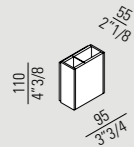

**APOR0564**

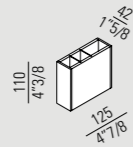

**APOR0565**

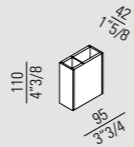

**APOR0566**  
Contenitore / Container / Behälter / Récipient / Contenedor

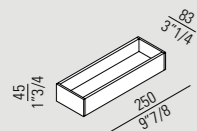

**APOR0567**

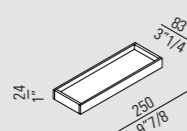

**APOR0568**

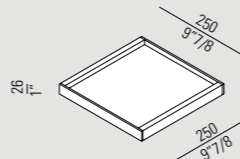

**APOR0561**  
Porta salviette / Towel holder / Handtuchhalter / Porte-serviettes / Toallero

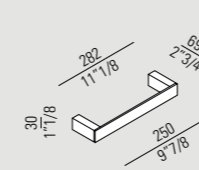

**APOR0562**

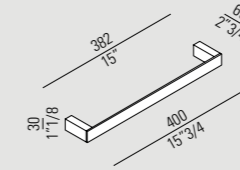

**APOR0563**

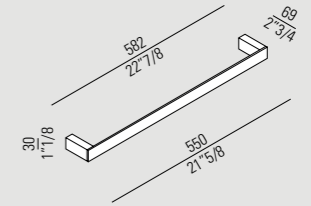

**APOR0560**  
Porta abiti / Clothes hanger / Kleiderhaken / Patères / Perchero

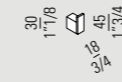

**APOR0569**  
Porta rotolo / Toilet roll holder / Toilettenpapierhalter / Porte-rouleau papier toilette / Portarollo

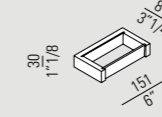

**APOR0572**  
Porta scopino / Toilet brush holder / Toilettenbürste / Porte-balai WC / Porta escobilla

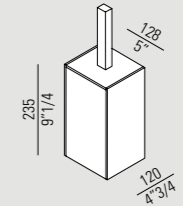

**APOR0570**

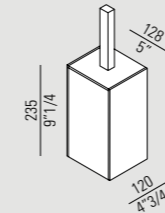

**Sen** / 2008

Un programma componibile di accessori, realizzati in alluminio anodizzato spazzolato nero, che disegnano un'unica linea essenziale nello spazio bagno. Gli accessori Sen risolvono tutte le situazioni e le funzioni dell'ambiente bagno, con uno stile ed una versatilità sorprendenti.

A modular range of accessories that create a single, essential line in the bathroom. Made from brushed anodised aluminium, available in black. The Sen range of accessories provides surprisingly stylish and versatile solutions to all the functions required in a bathroom.

Ein moduläres Programm von Accessoires aus schwarzem Aluminium, eloxiert und gebürstet, das eine einzige, puristische Linie in den Baderaum zaubert. Accessoires Sen lösen alle Situationen und Funktionen im Badezimmer mit überraschendem Stil und Vielseitigkeit.

Un programme composable d'accessoires, réalisés en aluminium anodisé brossé noir, qui dessinent une ligne essentielle unique dans la salle de bain. Les accessoires Sen résolvent toutes les situations et les fonctions de l'espace salle de bain, avec un style et une flexibilité surprenantes.

Un programa modular de accesorios en aluminio anodizado cepillado negro, que dibujan una única línea en el cuarto de baño. Los accesorios Sen resuelven todas las situaciones y funciones en el cuarto de baño con un estilo y versatilidad sorprendentes.

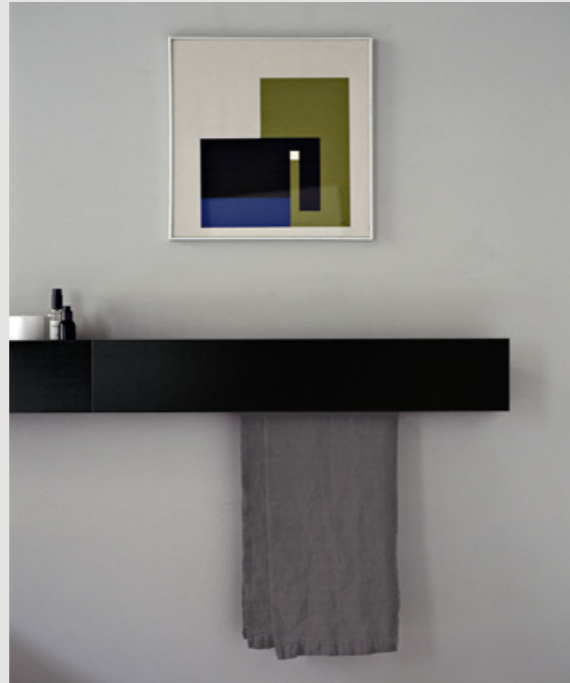

design Nicolas Gwenael, Curiosity

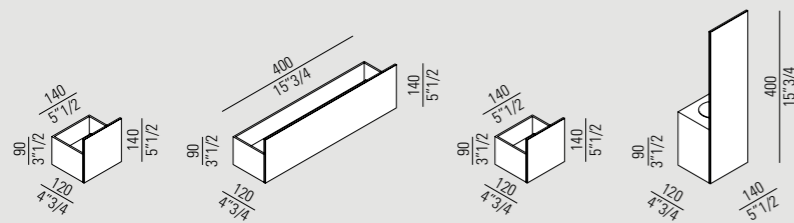

○ **Sen**  
rubinetteria, taps, armatur,  
robinetterie, griferia  
→ Tools vol. 3

○ **Pear 2**  
sanitari, sanitary ware,  
WCs und bidets, sanitaires,  
sanitarios  
→ Tools vol. 1

**Sen** / 2008 – 2012

La collezione Sen è completata da uno scalda salviette autoregolante, sempre in alluminio spazzolato nero, in sintonia con l'ispirazione minimalista di questo progetto.

The Sen collection is complete with a self-regulating heated towel rail, also in black brushed aluminium, to match the minimalist spirit of the entire range.

Die Kollektion Sen wird durch einen selbstregelnden Handtuchtrockner komplettiert, ebenfalls in Aluminium schwarz gebürstet, in Harmonie mit dem minimalistischen Design der Serie.

La collection Sen est complétée par un chauffe-serviettes avec autorégulation, toujours en aluminium brossé noir, en harmonie avec le style minimaliste de ce projet.

La colección Sen se completa con un toallero calefactor con autorregulación, también en aluminio cepillado negro, en sintonía con la inspiración minimalista de este proyecto.

400W – 230V  
IP 67 cl 2

design Nicolas Gwenael, Curiosity

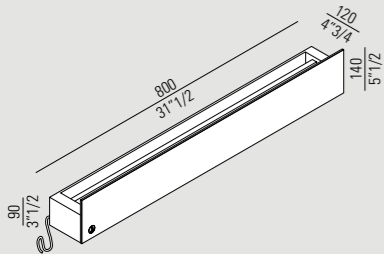

**Sen** / 2008

Accessori realizzati in alluminio anodizzato spazzolato con finitura nera abbinabile all'omonima serie di rubinetti.

Accessories made from brushed anodised aluminium available in black, to be matched with the Sen tap range.

Accessoires aus eloxiertem, gebürstetem, schwarzem Aluminium, kombinierbar mit der gleichnamigen Armaturensérie.

Accessoires en aluminium anodisé brossé avec finition noire assortie à la série de robinets du même nom.

Accesorios de aluminio anodizado cepillado con acabado negro combinable con la grifería homónima.

**Accessori / Accessoires**

**ASEN0915N**  
Mensola / Shelf / Spiegelablage / Tablette / Repisa

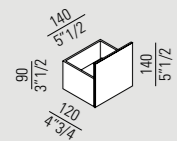

**ASEN0917N**

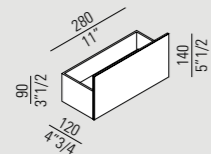

**ASEN0921N**

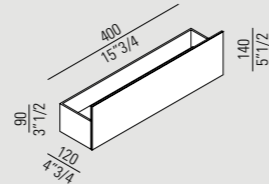

**ASEN0923N**

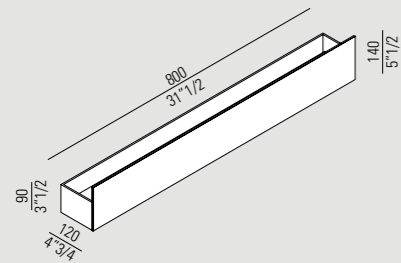

**ASEN0919N**  
Porta salviette / Towel holder / Handtuchhalter / Porte-serviettes / Toallero

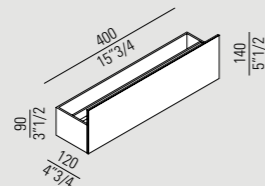

**ASEN0922N**

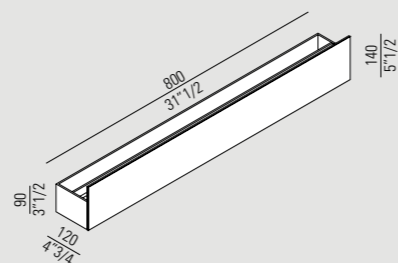

**ASEN0974N**  
Porta abiti / Clothes hanger / Kleiderhaken / Patères / Perchero

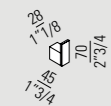

**ASEN0972N**  
Porta rotolo / Toilet roll holder / Toilettenpapierhalter / Porte-rouleau papier toilette / Portarollo

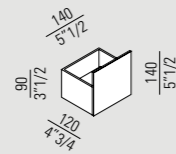

**ASEN0925N**  
Porta scopino / Toilet brush holder / Toilettenbürste / Porte-balai WC / Porta escobilla

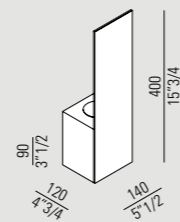

**ASEN0976N**  
Scalda salviette / Heated towel rail / Handtuchtrockner / Chauffe serviettes / Calentador de toallas

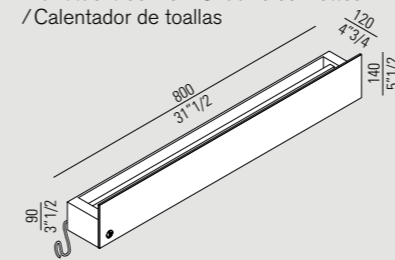

**Surf** / 2007

Una serie di accessori in Exmar bianco, studiati per affiancare i vassoi della zona lavabo, porgendo tutto quanto serve, con uno stile particolare: dallo spazzolino da denti, al sapone liquido, agli altri oggetti per l'igiene e la bellezza.

A range of accessories in white Exmar, designed to go with the trays in the washbasin area, stylishly keeping everything you need to hand: from toothbrush to liquid soap, as well as other toiletries and beauty products.

Eine Serie von Accessoires aus weißem Exmar, die die Waschbecken-ablagen um alles stilvoll in Reichweite zu haben: Zahnbürste, Flüssigseife und alle sonstigen Utensilien für Hygiene und Schönheitspflege.

Une série d'accessoires en Exmar blanc, pensés pour accompagner les plateaux de la zone lavabo, présentant tout le nécessaire, avec un style particulier: de la brosse à dents, au savon liquide, en passant par tous les autres objets au service de l'hygiène et de la beauté.

Una serie de accesorios en Exmar blanco, pensados para ser combinados con las bandejas de la zona lavabo, presentando todo lo necesario con un estilo particular: el cepillo de dientes, el jabón líquido y todos los objetos al servicio de la higiene personal y la belleza.



design Benedini Associati

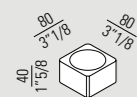

ACOM0632Z

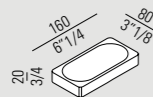

ACOM0631Z

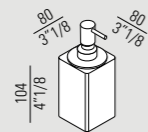

ACOM0633Z

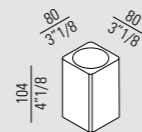

ACOM0634Z



369 / 2004

Un programma completo di accessori, progettati per soddisfare ogni possibile esigenza di installazione e d'uso, con uno stile rigorosamente contemporaneo. Gli accessori del programma 369 sono realizzati in acciaio inox lucido o satinato, con elementi in Cristalplant®biobased bianco.

A full range of accessories designed to satisfy any possible installation and use requirement, in a rigorously contemporary style. The accessories in the 369 range are made from polished or satin-finished stainless steel, with white Cristalplant®biobased elements.

Diese komplette Serie von Accessoires, rigoros im zeitgenössischen Stil, wurde entwickelt, um allen Anforderungen von Installation und Gebrauch gerecht zu werden. Die Accessoires im Programm 369 sind aus glänzendem oder satiniertem Edelstahl, mit Elementen aus weißem Cristalplant®biobased.

Un programme complet d'accessoires, conçus pour satisfaire n'importe quelle exigence d'installation et d'utilisation, avec un style rigoureusement contemporain. Les accessoires du programme 369 sont réalisés en acier inox poli ou satiné, avec éléments en Cristalplant®biobased blanc.

Un programa completo de accesorios diseñados para satisfacer todas las exigencias posibles de instalación y uso, con un estilo rigurosamente contemporáneo. Los accesorios del programa 369 se fabrican en acero inoxidable brillo o satinado, con elementos de Cristalplant®biobased blanco.



design Benedini Associati

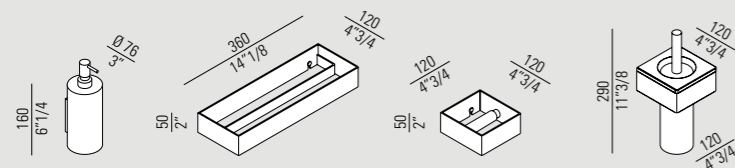

Finiture / Finishes





**369** / 2004

Programma di accessori e lampade. Supporti realizzati in acciaio inox satinato o lucido, ed elementi in Cristalplant®biobased bianco.

Range of accessories and lights. Support elements in satin finish or polished stainless steel, and elements in white Cristalplant®biobased.

Serie von Accessoires und Leuchten. Grundelemente aus satiniertem oder poliertem Edelstahl und Elemente aus weißem Cristalplant®biobased.

Programme d'accessoires et d'appliques. Supports réalisés en acier inox satiné ou poli et éléments en Cristalplant®biobased blanc.

Programa de accesorios y lámparas. Soportes de acero inoxidable satinado o brillo y elementos de Cristalplant®biobased blanco.

**Accessori / Accessoires**

**A369222 / A369200**

Elemento accessoriabile / Basic support element / Grundelement / Support à compléter / Elemento a completar

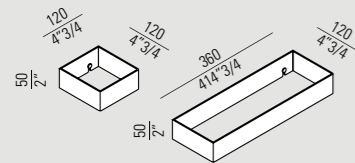

**A369201 / A369202**

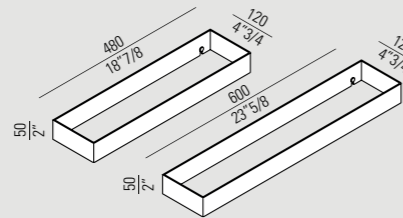

**A369203**

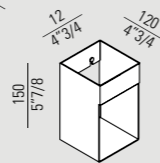

**A369204**

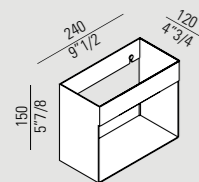

**A369205**

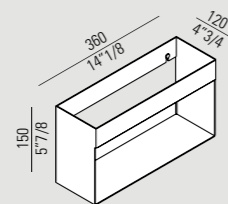

**A369206**

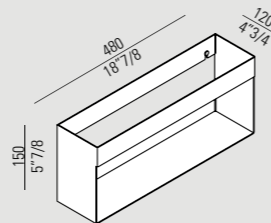

**A369207 / A369208**

Porta salviette / Towel holder / Handtuchhalter / Porte-serviettes / Toallero

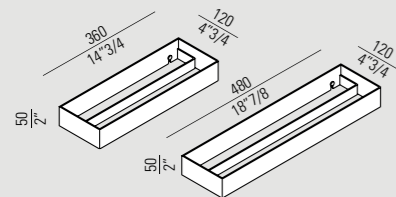

**A369209**

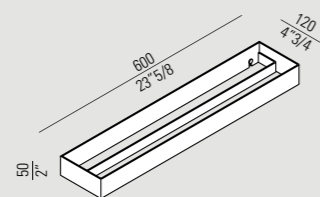

**A369210Z**

Mensola / Shelf / Spiegelablage / Tablette / Repisa

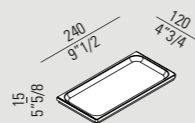

**A369211Z / A369212Z**

Porta sapone / Soap holder / Seifenschale / Porte-savon / Porta jabón

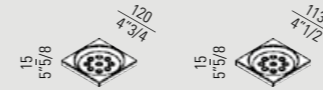

**A369228Z / A369224**

Dispenser per sapone / Liquid soap dispenser / Seifenspender / Distributeur de savon liquide / Dispensador de jabón líquido

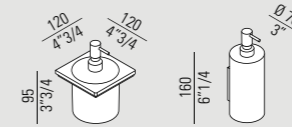

**A369213Z**

Porta spazzolini / Toothbrush holder / Zahnbürstenhalter / Porte-brosses à dents / Porta cepillos de dientes

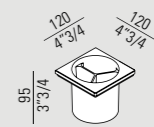

**A369223**

Porta abiti / Clothes hanger / Kleiderhaken / Patères / Perchero

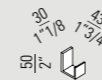

**A369214 / A369219**

Porta rotolo / Toilet roll holder / Toilettenpapierhalter / Porte-rouleau papier toilette / Portarollo

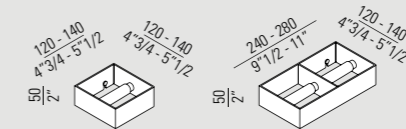

**A369218**

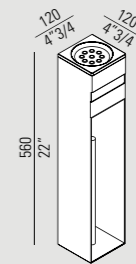

**A369215**

Porta scopino / Toilet brush holder / Toilettenbürste / Porte-balai WC / Porta escobilla

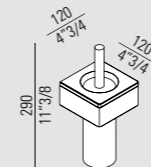

**A369216**

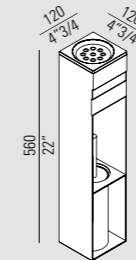

**A369217**

Gettacarta / Wastepaper basket / Papierkorb / Corbeille à papier / Papelera

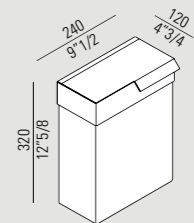

**A369227**

Lampada / Lampada / Wandleuchte / Applique / Lámpara

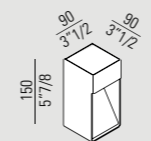

**A369226**

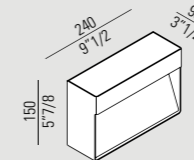

**A369225**

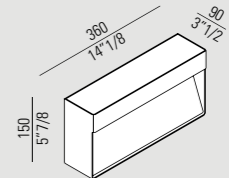

Idee divertenti e funzionali, sorprendenti e comode, capaci di andare oltre le solite convenzioni e di esprimere un concetto evoluto di stanza da bagno: tutto questo è Agape, nelle grandi come nelle piccole soluzioni.

Fun and functional ideas, surprising and convenient, capable of going beyond the usual conventions and expressing an advanced concept of bathroom design: all this is Agape, in both large and small solutions.

Amüsante und funktionale Ideen, überraschend und bequem, die über die gewohnten Konventionen hinausgehen und ein entwickeltes Konzept von Badezimmer zum Ausdruck bringen: all das ist Agape, sowohl im Kleinen als auch im Großen.

Des idées amusantes et fonctionnelles, surprenantes et pratiques, capables d'aller au-delà des conventions habituelles et d'exprimer un concept moderne de salle de bains: c'est l'essence même d'Agape, présente aussi bien dans les petites que dans les grandes solutions.

Ideas divertidas y funcionales, sorprendentes y cómodas, capaces de superar las convenciones habituales y expresar un concepto evolucionado de cuarto de baño: todo esto es Agape, en las soluciones grandes y en las pequeñas.

**pag**

114	Basket
116	Diapason
118	Midi Basket
120	Multifunzione
122	Pic-nic
124	Ritz
126	Roto
128	Stairs
130	Surf
132	Tapiro
134	X

**Agape tools 3:**  
**Complementi / Extras /**  
**Zubehör / Complé-**  
**ments / Complemen-**  
**tos** → pag 114.

**Basket** / 1992

Capiente contenitore di forma cilindrica in multistrato curvato, disponibile con finitura in rovere naturale, bruno, scuro, in teak oppure nei colori bianco o grigio. Il contenitore Basket è utilizzabile anche come seduta. I fori sui lati permettono di spostarlo agevolmente, anche senza aprire il coperchio.

A roomy, cylindrical-shaped container. Made of curved plywood and available in a natural, brown or dark oak finish, in teak or in a white or grey colour. The Basket container can also be used as a seat. Holes in the sides make it easy to move it around without any need to open the lid.

Geräumiger Behälter in Zylinderform. Aus gebogenem Schichtholz in den Ausführungen Eiche natur, braun, dunkel oder Teak, außerdem in weiß oder grau. Der Behälter Basket kann auch als Hocker verwendet werden. Die Grifflöcher auf den Seiten lassen ihn leicht verschieben, auch ohne den Deckel zu öffnen.

Grand coffre cylindrique en multiplis cintré, disponible dans la finition chêne naturel, brun, foncé, en teck ou dans les coloris blanc ou gris. Le coffre Basket peut servir de tabouret. Les trous latéraux permettent de le déplacer facilement sans devoir ouvrir le couvercle.

Contenedor espacioso, cilíndrico fabricado en contrachapado curvo, disponible con acabado roble natural, marrón, oscuro, de teca o lacado blanco y gris. El contenedor Basket se puede utilizar como taburete. Puede moverse fácilmente gracias a sus sus huecos laterales, incluso sin abrir la tapa.



design Benedini Associati

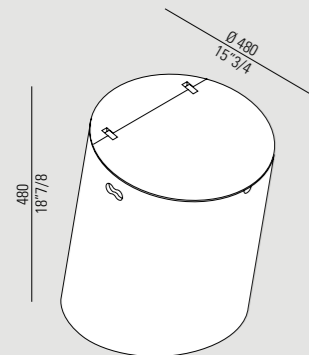

ACOM0510\_

Finiture / Finishes

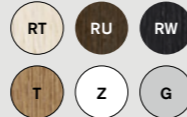

**Diapason**/2001

Linee sottili e armoniose per Diapason, il portarotoli multiplo in acciaio inox satinato.

Slim and elegant lines for Diapason, a multiple toilet roll holder in satin-finish stainless steel.

Schlanke, harmonische Linien für Diapason, den Vorratstoilettenpapierhalter aus satiniertem Edelstahl.

Lignes fines et harmonieuses pour Diapason, le porte-rouleaux en acier inox satiné.

Líneas sutiles y armoniosas para Diapason, el portarrollos múltiple de acero inoxidable satinado.

design Marco Zito

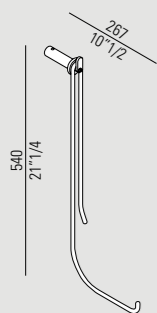

ACOM0553SP



**Midi Basket** / 1996

Questo elegante gettacarte può essere installato a parete o appoggiato sul pavimento. Realizzato in multistrato curvato, con finitura in rovere naturale, bruno, scuro, in teak o nei colori bianco o grigio.

This elegant wastepaper basket can be wall mounted or floor standing. Made of curved plywood, with a natural, brown or dark oak finish, in teak or in a white or grey colour.

Dieser elegante Papierkorb kann wandhängend montiert oder auf den Boden gestellt werden. Aus gebogenem Schichtholz in den Ausführungen Eiche natur, braun, dunkel oder Teak, außerdem in weiß oder grau.

Cet élégant panier-poubelle peut être fixé au mur ou posé au sol. Il est réalisé en multiplis cintré, disponible dans la finition chêne naturel, brun, foncé, en teck ou dans les coloris blanc ou gris.

Esta elegante papelera puede fijarse a pared o apoyarse en el suelo. Fabricada en contrachapado curvo, con acabado roble natural, marrón, oscuro, de teca o lacada en blanco o gris.

design Benedini Associati

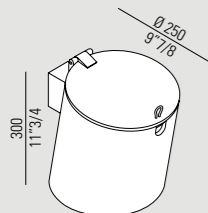

ACOM0601\_

Finiture / Finishes

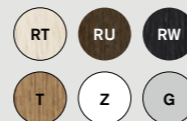

**Multifunzione** / 2009

Tutto realizzato in Exmar bianco, è un comodo accessorio portaoggetti e portasalviette, da affiancare alla vasca o al lavabo.

Completely made from white Exmar, this is a useful towel holder and shelf, to be placed near a bathtub or washbasin.

Ganz aus Exmar ist dieses praktische Accessoire zur Aufnahme von Utensilien und Handtüchern, das neben Wanne oder Waschtisch gestellt werden kann.

Entièrement réalisé en Exmar blanc, c'est un accessoire astucieux porte-objets et porte-serviettes, à placer près de la baignoire ou du lavabo.

Completamente fabricado en Exmar blanco, es un cómodo accesorio portaobjetos y toallero, para colocar cerca de la bañera o del lavabo.

design Benedini Associati

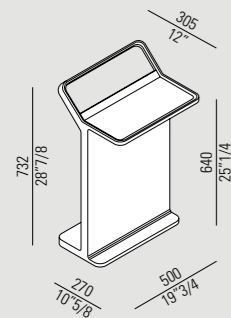

ACOM0509Z



**Cartesio**  
vasca, bathub, badewanne,  
baignoire, bañera  
→ Tools vol. 2



**Pic-nic** / 1993

Pratico porta salviette pieghevole disponibile con finitura rovere naturale, bruno, scuro, tinto teak, oppure nei colori bianco o grigio.

A practical folding towel holder in a natural, brown or dark oak finish, painted teak or in a white or grey colour.

Praktischer, zusammenklappbarer Handtuchhalter in den Ausführungen Eiche natur, braun, dunkel oder Teak gefärbt, außerdem in weiß oder grau.

Porte-serviettes pliant disponible dans la finition chêne naturel, brun, foncé, teint en teck ou dans les coloris blanc ou gris.

Práctico toallero plegable, disponible con acabado roble natural, marrón, oscuro o barnizado color teca, o también lacado en blanco o gris.



design Benedini Associati

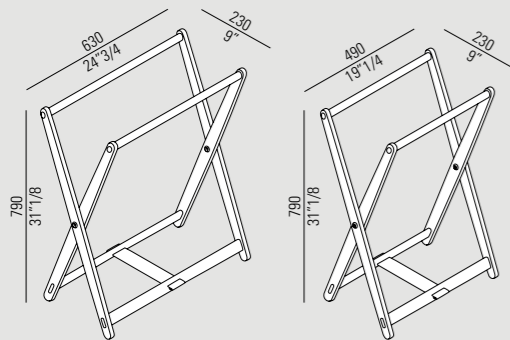

ACOM0530\_

ACOM0530\_S

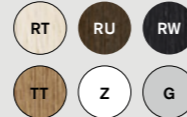
**Finiture / Finishes**

**Ritz** / 1994

Un tocco e Ritz ruota su se stesso, permettendo l'erogazione del sapone liquido. Il contenitore è realizzato in vitreous china bianco con supporto e tappo in acciaio inox lucido.

At a touch, Ritz rotates on itself to dispense liquid soap. The container is in white vitreous china with polished stainless steel bracket and top.

Ein leichtes Antippen genügt und Ritz dreht sich um die eigene Achse und ermöglicht somit den Austritt der Flüssigseife. Behälter aus weißem Porzellan mit Halterung und Deckel aus glänzendem Edelstahl.

Une simple geste et Ritz tourne sur lui-même, permettant ainsi la distribution du savon liquide. Le distributeur est réalisé en vitreous china blanc avec support et bouchon en acier inox poli.

Un toque y Ritz gira sobre sí mismo, facilitando la distribución del jabón líquido. El contenedor es de cerámica blanca y el soporte y tapón de acero inoxidable brillo.



design Benedini Associati

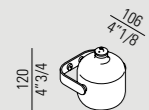

ACOM0993Z





**Roto** / 2006

I contenitori Roto ampliano la gamma degli omonimi lavabi e sono caratterizzati dal medesimo design sinuoso. Utilizzabili anche come seduta, nei più diversi spazi della casa. Disponibili nei colori laccati bianco, arancio, verde e grigio.

Roto storage units complement the range of washbasins that go by the same name and feature the same curvy design. They can also be used as a seat in many different places around the house. Available in lacquered white, orange, green and grey.

Die Behälter Roto ergänzen die gleichnamigen Waschbecken und zeichnen sich durch das gleiche geschwungene Design aus. Auch als Hocker in jedem anderen Raum der Wohnung verwendbar. Erhältlich in weiß, orange, grün und grau lackiert.

Ces articles de rangement Roto complètent la gamme des lavabos portant le même nom et sont caractérisés par le même design sinueux. Il peuvent aussi être utilisés comme siège et placés partout dans la maison. Disponibles dans les couleurs laquées blanc, orange, vert et gris.

Los contenedores Roto amplían la gama de los lavabos de la misma serie y se caracterizan por un diseño igualmente sinuoso. Se pueden usar también como taburete, en cualquier espacio de la casa. Disponibles en colores lacados blanco, naranja, verde y gris.



design Maurizio Negri, Benedini Associati

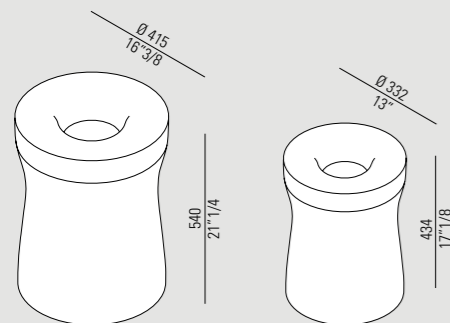

ACOM0792\_

ACOM0791\_

Finiture / Finishes



**Stairs** / 1996

I complementi Stairs si appoggiano semplicemente alla parete, senza fori di fissaggio. Sono disponibili in rovere naturale, bruno, scuro, o tinto teak oppure in bianco o grigio laccati. La versatilità e l'immediatezza dei complementi Stairs, permettono di dare vita alle più diverse composizioni: per risolvere un angolo altrimenti inutilizzato, come per caratterizzare un intero ambiente.

Stairs accessories simply stand against the wall; no fixing holes are necessary. They are available in natural, brown and dark oak, painted teak or in a white or grey lacquered finish. The versatility and immediacy of Stairs accessories mean you can create a wide variety of solutions, bringing life to an otherwise unused corner, or constituting the central theme for an entire room.

Die Elemente Stairs können einfach an die Wand gelehnt werden, ohne Befestigungslöcher. Erhältlich in Eiche natur, braun, dunkel oder Teak gefärbt, oder lackiert in weiß oder grau. Vielseitigkeit und direkte Aufstellung von Stairs lassen unterschiedlichste Kompositionen entstehen: um eine tote Ecke sinnvoll zu nutzen oder einem Ambiente einen besonderen Charakter zu geben.

Les éléments Stairs s'appuient simplement contre le mur, sans trous de fixation. Ils sont disponibles en chêne naturel, brun, foncé, teint en teck ou en laqué blanc ou gris. Polyvalents et immédiats, les éléments Stairs permettent de créer les compositions les plus variées : pour aménager le coin qui resterait inutilisé, ou pour caractériser tout l'espace.

Los complementos Stairs se apoyan simplemente contra la pared, sin taladros de fijación. Disponibles en roble natural, marrón, oscuro o barnizado color teca, o también lacados en blanco o gris. La versatilidad y la facilidad de colocación de los complementos Stairs permiten crear distintas composiciones: para decorar un rincón inutilizado o para personalizar un espacio en general.



design Benedini Associati

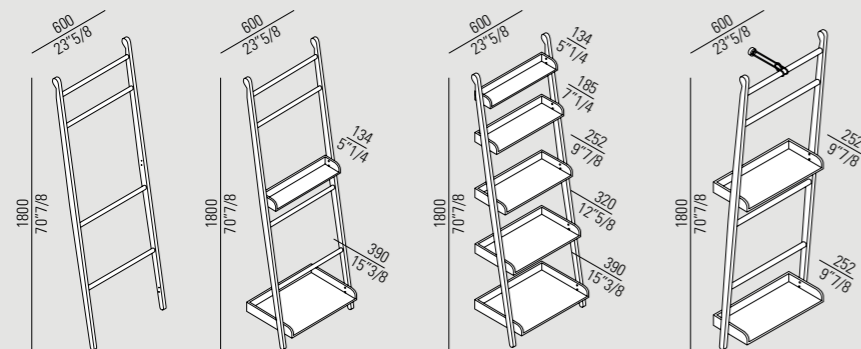

ACOM0531\_

ACOM0532\_

ACOM0534\_

ACOM0533\_

## Finiture / Finishes

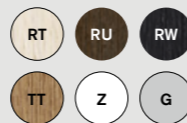

**Surf** / 2006

I vassoi Surf possono essere collocati liberamente sui piani d'appoggio, risolvendo con immediatezza ogni necessità. Disponibili in tre misure, tutti con conca portasapone, sono realizzati in Solid surface bianco. Surf può essere posizionato in appoggio sui bordi dei lavabi Agape Woodline, 002 o 003 risolvendo in modo semplice la disposizione degli oggetti utilizzati.

Surf trays can be freely placed on countertops, offering an immediate answer to all storage needs. Available in three sizes, all with soap dish, they are made in white Solid surface. Surf can be placed on the edges of Agape Woodline, 002 or 003 washbasins, providing a simple way to keep frequently-used objects to hand.

Die Ablagen Surf können beliebig auf horizontale Oberflächen gestellt werden. Lieferbar in drei Maßen, alle mit Seifenablage, aus weißem Solid surface. Surf kann auf die Ränder der Agape Waschbecken Woodline 002 oder 003 gelegt werden und bietet somit Ablagefläche für häufig verwendete Gegenstände.

Les plateaux Surf peuvent être posés librement sur les plans d'appui et satisfaire ainsi les moindres exigences. Disponibles en trois dimensions et tous munis d'un porte-savon modelé dans la tablette, ils sont réalisés en Solid surface blanc. Surf peut être posé sur les bords des lavabos Agape Woodline, 002 ou 003 pour disposer aisément les accessoires utilisés.

Las bandejas Surf son de libre disposición sobre encimeras, resolviendo inmediatamente cualquier necesidad. Disponibles en tres medidas, todos con jabonera, están fabricadas en Solid surface blanco. Surf puede apoyarse sobre los lavabos Agape Woodline, 002 o 003 y solucionar con sencillez la disposición de los objetos utilizados.

**Fez**  
rubinetteria, taps, armatur,  
robinetterie, grifería  
→ Tools vol. 3

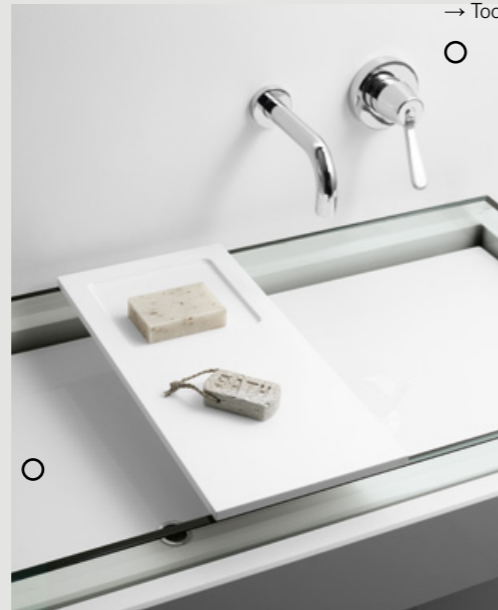

**003**  
lavabo, washbasin,  
waschbecken, lavabo,  
lavabo  
→ Tools vol. 1

design Benedini Associati

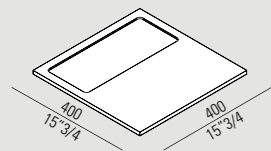

ACOM0626Z

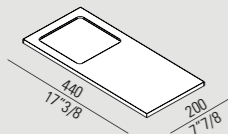

ACOM0625Z

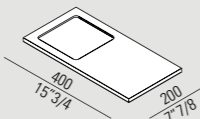

ACOM0627Z



**Tapiro** / 1992

Un tappeto per il bagno di ispirazione etnica, realizzato con bacchette tonde in rovere naturale, bruno, scuro, o in teak connesse con lacci di cuoio.

A bath mat with an ethnic feel, made of round rods in natural, brown or dark oak or in teak held together by leather thongs.

Ein ethnisch angehauchter Badezimmerteppich aus Rundstäben in Eiche natur, braun, dunkel, oder in Teak, die durch Lederbänder verbunden werden.

Un tapis pour la salle de bains d'inspiration ethnique, réalisé avec des baguettes arrondies en chêne naturel, brun, foncé, ou en teak retenues par des lacets en cuir.

Una alfombrilla para el baño de inspiración étnica, realizada con varillas redondas de roble natural, marrón, oscuro o de teca, unidas con cordones de cuero.

design Alessandro Farnetti

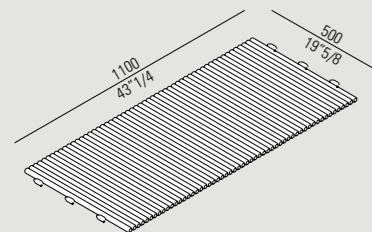

AKAR0524L\_

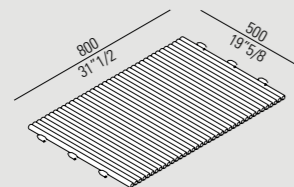

AKAR0524\_

Finiture / Finishes



X / 2012

Un comodo e versatile accessorio realizzato in legno con finitura rovere naturale, bruno, scuro o tinto teak. La struttura, alta o bassa, può essere accessorata con il vassoio, utilizzabile come tavolino o portaoggetti. Senza vassoio la struttura alta è un pratico porta salviette mentre la struttura bassa diventa anche sgabello con la seduta in cuoio naturale o nero.

A handy, versatile wooden accessory in a natural, brown or dark oak finish or painted teak. The tall or short structure can be accessorised with a tray to create a handy table or portable storage shelf. Without the tray, the tall structure becomes a handy towel rack, while the shorter version can also become a stool, with a black or tan leather seat.

Ein bequemes, vielseitiges Element aus Holz im Dekor Eiche natur, braun, dunkel oder Teak gefärbt. Das Gestell, hoch oder niedrig, wird mit einem Tablett zum kleinen Tisch oder zur nützlichen Ablage. Ohne Tablett ergibt das hohe Gestell einen praktischen Handtuchhalter, das niedrige Gestell mit dem Sitz aus Leder natur oder schwarz einen praktischen Hocker.

Un accessoire commode et polyvalent, réalisé en bois dans la finition chêne naturel, brun, foncé ou teint en teck. La structure, haute ou basse, peut être complétée par le plateau, utilisable comme petite table ou porte-objets. Sans plateau, la structure haute est un porte-serviettes tandis que la structure basse elle devient tabouret avec une assise en cuir naturel ou noir.

Un accesorio cómodo y versátil realizado en madera, con acabado roble natural, marrón, oscuro o barnizado color teca. La estructura, alta o baja, puede incorporar distintos accesorios como la bandeja, usada como mesa o portaobjetos. Sin la bandeja, la estructura alta es un práctico toallero mientras que la estructura baja se transforma en una banqueta con asiento de cuero natural o negro.



Vieques  
vasca, bathtub, badewanne,  
baignoire, bañera  
→ Tools vol. 2

design Benedini Associati

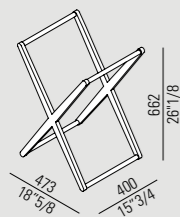

ACOM0539\_

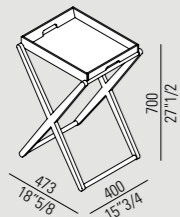

ACOM0622\_

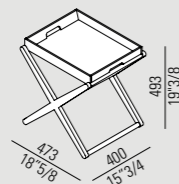

ACOM0623\_

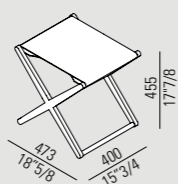

ACOM0538\_

Finiture / Finishes

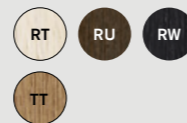

369  
accessori, accessories,  
accessoires, accessoires,  
accorios  
→ Tools vol. 3

Square  
rubinetteria, taps, armatur,  
robinetterie, griferia  
→ Tools vol. 3



In-Out  
vasca, bathtub,  
badewanne, baignoire,  
bañera  
→ Tools vol. 2

**Agape info:**  
**Rubinetti/Taps/Armaturen/Robinetterie/Grifería**  
 → pag 137, **Accessori/Accessories/Accessoires/Accessoires/Accesorios** → pag 138, **Complementi/Extras**  
**/Zubehör/Compléments/Complementos** → pag 138.

+

**Glossario materiali/Glossary of materials/**  
**Glossar Materialien/Glossaire des matériaux**  
**/Glosario de materiales** → pag 140.

**Rubinetti/Taps**

**Fez**  
 design Benedini Associati  
 → 06, 07, 08, 09, 10, 11, 12,  
 13, 14, 15, 16, 17, 18, 19

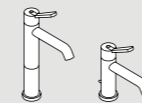

**Fez**  
 design Benedini Associati

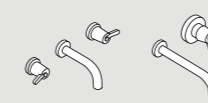

**Fez**  
 design Benedini Associati

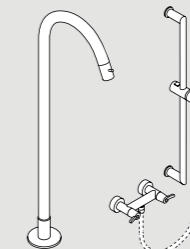

**Memory**  
 design Benedini Associati  
 → 20, 21, 22, 23, 24, 25, 26,  
 27

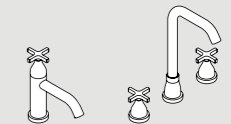

**Memory**  
 design Benedini Associati



**Memory**  
 design Benedini Associati

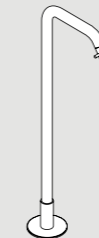

**Sen**  
 design Nicolas Gwenael  
 Curiosity → 28, 29, 30, 31, 32,  
 33, 34, 35, 36, 37, 38, 39

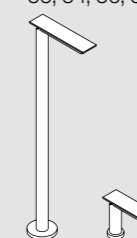

**Sen**  
 design Nicolas Gwenael  
 Curiosity

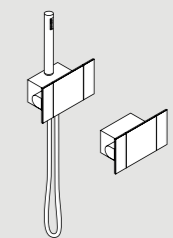

**Sen**  
 design Nicolas Gwenael  
 Curiosity



**Square**  
 design Benedini Associati  
 → 40, 41, 42, 43, 44, 45, 46,  
 47, 48, 49, 50, 51, 52, 53

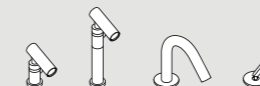

**Square**  
 design Benedini Associati

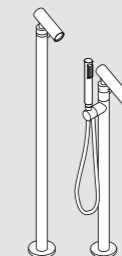

**Square**  
 design Benedini Associati

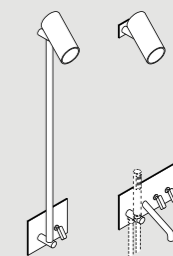

**Square**  
 design Benedini Associati

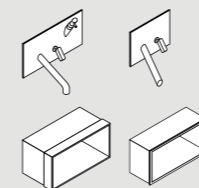

**Suite**  
 design Benedini Associati  
 → 54, 55, 56, 57, 58, 59

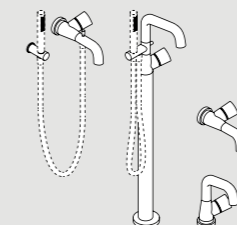

**Rubinetteria/ Tapware extras**

**Al dente**  
 Davide Borin, Nicola Gibertini,  
 Mattia Vittori  
 → 60, 61

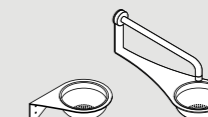

**ARUB400/401**  
 design Benedini Associati  
 → 62, 63

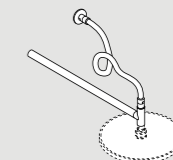

**Accessori / Accessoires**

**Hydro**  
design Giulio Gianurco,  
UT Agape  
→ 64, 65

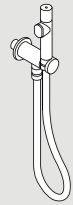

**Kaa**  
design Giulio Gianurco  
→ 66, 67

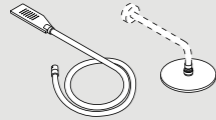

**Doccette e soffioni**  
→ 68, 69, 70, 71

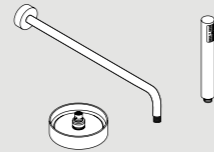

**Bucatini**  
design Fabio Bortolani,  
Ermanno Righi  
→ 74, 75, 76, 77

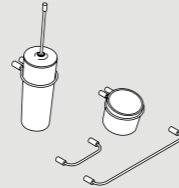

**Mach**  
design Konstantin Grcic  
→ 78, 79, 80, 81

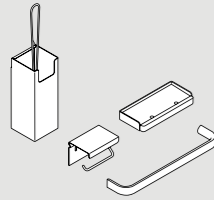

**Memory**  
design Benedini Associati  
→ 82, 83, 84, 85, 86, 87

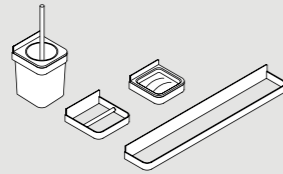

**O**  
design Marco Ferreri  
→ 88, 89, 90, 91

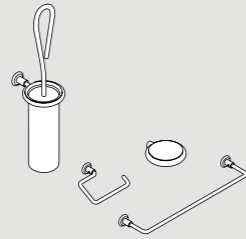

**O.L.C**  
design Benedini Associati  
→ 92, 93, 94, 95

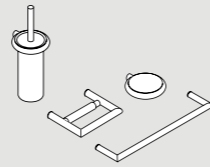

**Porto**  
design Claudio La Viola  
→ 96, 97, 98, 99

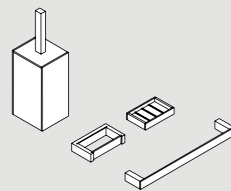

**Sen**  
design Nicolas Gwenael,  
Curiosity  
→ 100, 101, 102, 103, 104,  
105

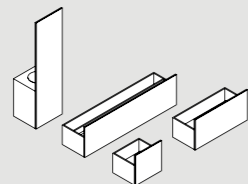

**Surf**  
design Benedini Associati  
→ 106, 107

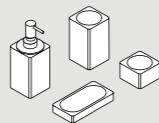

**369**  
design Benedini Associati  
→ 108, 109, 110, 111

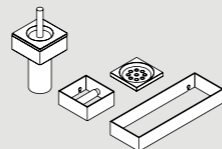

**Complementi / Extras**

**Basket**  
design Benedini Associati  
→ 114, 115

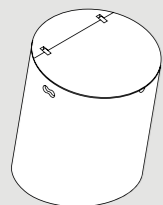

**Diapason**  
design Marco Zito  
→ 116, 117

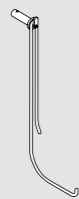

**Midi Basket**  
design Benedini Associati  
→ 118, 119



**Multifunzione**  
design Benedini Associati  
→ 120, 121

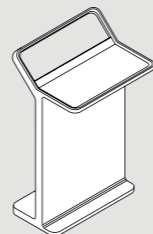

**Pic-nic**  
design Benedini Associati  
→ 122, 123

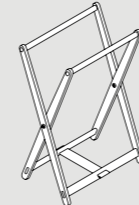

**Ritz**  
design Benedini Associati  
→ 124, 125



**Roto**  
design Maurizio Negri,  
Benedini Associati  
→ 126, 127



**Stairs**  
design Benedini Associati  
→ 128, 129

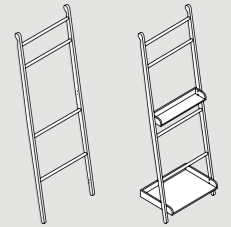

**Surf**  
design Benedini Associati  
→ 130, 131

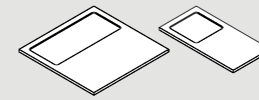

**Tapiro**  
design Alessandro Farnetti  
→ 132, 133

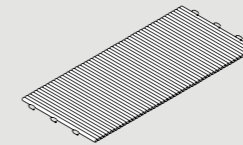

**X**  
design Benedini Associati  
→ 134, 135

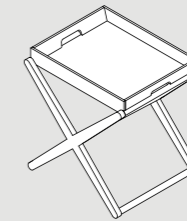

## Glossario materiali

### 1) Legno

Il patrimonio tecnologico della cantieristica navale è un dato fondamentale nella progettazione di elementi in legno per il bagno. L'invecchiamento esalta le naturali doti estetiche del legno aumentando le prestazioni tecnologiche. Esteticamente ciò che più affascina del legno è il suo ciclo di vita, l'aspetto cangiante legato al passare del tempo e delle stagioni misurato attraverso il lento mutare della superficie, delle venature e del colore.

### 2) Cristalplant®biobased

Cristalplant®biobased è un materiale eco-sostenibile derivante da materie prime resinose di origine vegetale miscelate a materiali inerti naturali di estrema purezza. La superficie, con effetto "soft-touch" ha un aspetto simile alla pietra naturale che lo rende particolarmente indicato per l'utilizzo nell'ambiente bagno. Il materiale è omogeneo in tutto il suo spessore e può facilmente essere ripristinato.



### 3) Exmar

Materiale ottenuto dalla composizione di resina e polvere di quarzo. La superficie, con finitura satinata bianca, è setosa, calda e piacevole al tatto. L'applicazione dell'Exmar nella realizzazione di vasche da bagno è ideale poiché il materiale possiede la capacità di trattenere a lungo il calore dell'acqua.

### 4) Solid surface

Materiale compatto e non poroso, composto in modo omogeneo da 1/3 di resina acrilica e da 2/3 di idrossido di alluminio, un minerale naturale con il quale molte persone si trovano quotidianamente a contatto, poiché costituisce, ad esempio, un componente importante dei dentifrici. Completamente atossico e riciclabile. La superficie si presenta omogenea, setosa al tatto, durevole e facile da pulire.

### 5) Ceramilux®

Materiale composito realizzato con cariche minerali naturali (carbonati di calcio e idrati di alluminio) miscelate a resina poliestere; rivestimento con gelcoat a base poliestere isoneopentilica. Ceramilux® è un

materiale non assorbente, resistente agli sbalzi di temperatura, ai graffi e all'abrasione.

### 6) Parapan®

Prodotto a base acrilica, Parapan® si presenta come un materiale monolitico, lucido, massiccio e uniformemente colorato. Materiale ecologico, privo di solventi, riciclabile al 100%, inalterabile nel tempo, i colori risultano resistenti ai raggi UV. La base acrilica, rende il Parapan® impermeabile, facilmente manutenibile e particolarmente adatto nell'impiego in ambienti umidi come il bagno.

### 7) Polietilene

Il Polietilene appartiene alla famiglia dei polimeri derivati dal monomero etilene. È la materia plastica più comune e trova larghissimo impiego. La possibilità di modellazione plastica dell'oggetto, la colorazione, l'intervento sulla texture, la leggerezza, nonché la riciclabilità, fanno del polietilene un materiale adatto alle applicazioni della produzione Agape.

### 8) Exacril

Exacril è un metacrilato di rivestimento con superficie lucida (100 gloss a specchio) nato come alternativo al laccato lucido. Il forte spessore, 1,4 mm, consente incollaggi anche sui bordi con difettosità infinitesimali e lo rende ripristinabile ad eventuali graffi. La superficie lucida è resistente nel tempo, non perde brillantezza e non si deforma, resiste al calore, è impermeabile e non assorbente. È un prodotto atossico ed ecologico.

### 9) Gomma siliconica

La gomma siliconica è un polimero elastomero contenente atomi di silicio e di ossigeno. Il composto è stabile ed irreversibile, le proprietà meccaniche ed elastiche del materiale non subiscono variazioni in intervalli di temperature elevate. Le caratteristiche peculiari della gomma siliconica sono la morbidezza, la totale atossicità e la colorazione pura; qualità che permettono un'applicazione ideale laddove il materiale entra a contatto diretto con il corpo e con l'acqua. La flessibilità permette di rimuovere facilmente il calcare che si deposita durante l'utilizzo del prodotto.

### 10) Ceramica

Impasto di sostanze argillose a struttura compatta modellato e quindi consolidato mediante processi di cottura che ne

garantiscono i processi di vetrificazione della superficie, di notevole resistenza meccanica ed elettrica.

### 11) Marmo

Roccia calcarea cristallizzata e compatta. La produzione Agape utilizza attualmente marmo bianco di Carrara con finitura satinata. I lavabi sono realizzati con lastre unite tramite incollaggio o scavati direttamente su blocco.

### 12) Acciaio Inox

Il termine acciaio inossidabile (o inox) indica genericamente gli acciai ad alta lega contenenti cromo ed altri leganti che aumentano la resistenza alla corrosione. Materiale con doti di resistenza, durezza ed elasticità molto maggiori di quelle del ferro semplice. I prodotti Agape in acciaio inox subiscono trattamenti superficiali di lucidatura o di satinatura.

### 13) Alluminio

L'alluminio è un metallo morbido e leggero con un colore argenteo vivo, dovuto ad uno strato sottile di ossidazione che si forma rapidamente quando è esposto all'aria. È estremamente resistente alla corrosione atmosferica: per tale ragione non richiede nessuna verniciatura di protezione, ma può essere ugualmente trattato con un'ampia gamma di rivestimenti, dalle verniciature alle anodizzazioni colorate. L'alluminio è non magnetico, non tossico e non infiammabile.

### 14) Ottone

Col nome di ottone si indica una lega di rame e zinco, compresa nella più ampia famiglia del bronzo. È un metallo molto utile, grazie alla sua resistenza e lavorabilità. I prodotti Agape in ottone subiscono trattamenti superficiali di cromatura lucida o di cromatura satinata.

### 15) Cristallo

Costituito essenzialmente da silicati è ottenuto per fusione di sabbia silicea con ossidi e carbonati. Grazie alla perfetta trasparenza, all'inalterabilità e alla capacità di reagire alla luce in forma mutevole, il cristallo trova particolare applicazione negli accostamenti con gli altri materiali che compongono la produzione Agape. Le giunzioni tra le parti sono realizzate con speciali collanti che garantiscono la perfetta trasparenza e continuità del materiale.

## Glossary of materials

### 1) Wood

The technological know-how gained in the ship-building industry is an essential factor when designing wooden components for the bathroom. Ageing enhances the natural appearance of wood, increasing its technological performance. Aesthetically, the most fascinating thing about wood is its life cycle, its changing appearance as time and seasons go by, evidenced by slow alteration of the surface, grain and colour.

### 2) Cristalplant®biobased

Cristalplant®biobased is an environmentally safe material deriving from resinous raw materials of plant origin mixed with natural aggregates of extreme purity. The "soft touch" surface looks like natural stone, which makes it particularly suitable for use in the bathroom. The material has a uniform structure throughout and can easily be touched up to restore the original finish.



### 3) Exmar

A composite material formed by a mix of resin and quartz powders. Its white, satin-finish surface is silky, warm and pleasant to the touch. It is ideal for use in the production of bathtubs as it is able to retain the heat of the water for a long time.

### 4) Solid surface

A compact, non-porous material which is a homogeneous mix of 1/3 resin and 2/3 aluminium hydroxide, a natural mineral with which many people are in daily contact as it constitutes, for example, an important ingredient of toothpaste. Completely non-toxic and recyclable. The surface is smooth, silky to the touch, durable and easy to clean.

### 5) Ceramilux®

Composite material made with natural mineral content (calcium carbonates and aluminium hydrates) mixed with polyester resins; coated with polyester-based iso-neopentyllic gelcoat. Ceramilux® is a non absorbent material, resistant to changes in temperature, scratches and abrasion.

### 6) Parapan®

An acrylic based product, Parapan® is a glossy, solid, monolithic material

that is coloured throughout. It is environmentally-friendly, solvent-free, 100% recyclable, extremely durable and its colouring is UV resistant. The acrylic base makes Parapan® waterproof, easy to maintain and particularly suitable for use in most environments, such as the bathroom.

### 7) Polyethylene

Polyethylene is part of the family of polymers deriving from the monomer ethylene. It is the most common plastic material and is widely used. The possibilities for moulding, colouring and texturing objects, its lightness and its recyclability make polyethylene an ideal material for Agape products.

### 8) Exacril

Exacril is a methacrylate used to give a glossy coating (100 gloss units), developed as an alternative to high-gloss paint finishes. Its 1.4 mm thickness means it can bond even edges with minor defects, and any scratches can be repaired. Its glossy surface is long-lasting, retains its original brightness and does not deform; it is heat resistant, waterproof and non-absorbent. A non-toxic and ecological product.

### 9) Silicone rubber

Silicone rubber is an elastomer polymer containing atoms of silicone and oxygen. The compound is stable and irreversible and its mechanical and elastic properties are not subject to alteration at higher temperatures. The specific characteristics of silicone rubber are softness, total non-toxicity and purity of colour. These qualities make it ideal for use where the material comes into direct contact with the body and water. Its flexibility allows easy removal of any lime scale deposited during use of the product.

### 10) Ceramic

A mixture of clayey substances with a compact structure that is moulded and then hardened by firing, which causes the surface to vitrify and acquire great mechanical and electrical resistance.

### 11) Marble

Marble is a compact, crystallized, calcareous rock. Agape currently uses white Carrara marble with satin-finish for its products. Washbasins are made from slabs joined together by gluing or carved directly out of the block.

### 12) Stainless steel

Stainless steel is the generic term for high alloy steels containing chromium and other alloying elements that increase resistance to corrosion. A material that is much stronger, harder and more resilient than plain iron. Agape stainless steel products are surface-treated to give a polished or satin finish.

### 13) Aluminium

Aluminium is a soft, light metal, with a bright silver colour due to the thin oxide layer which quickly forms when it is exposed to the air. It is extremely resistant to atmospheric corrosion and therefore does not require any protective varnish, although it can take a wide range of finishes, from varnish coating to coloured anodising treatments. Aluminium is neither magnetic, nor toxic, nor flammable.

### 14) Brass

Brass is an alloy of copper and zinc and forms part of the wider bronze family. It is a very useful metal because it is tough yet easy to work. Agape brass products are chromium-plated with a polished or satin finish.

### 15) Crystal glass

Consisting mainly of silicates, it is obtained by fusing siliceous sand with oxides and carbonates. Because of its perfect transparency, inalterability and its ability to react to light in different ways, crystal glass is particularly suitable for juxtaposition with the other materials used by Agape for its product ranges. Parts are joined using special adhesives that ensure perfect transparency and continuity of the material.

## Glossar der Materialien

### 1) Holz

Das technologische Erbe des Schiffbaus ist beim Entwurf von Elementen aus Holz für das Bad fundamental. Der Alterungsprozess hebt die natürlichen ästhetischen Qualitäten des Holzes hervor und verbessert seine technologischen Eigenschaften. Was ästhetisch am meisten am Holz fasziniert ist sein Lebenszyklus, sein wechselndes Aussehen, das dem Verlauf der Zeit unterliegt und sich anhand des langsamen Wandlungsprozesses der Oberfläche, der Maserung und der Farbe ablesen läßt.



2) **Cristalplant®biobased**  
Cristalplant®biobased ist ein ökologisch nachhaltiges Material. Es wird aus harzhaltigen Rohstoffen pflanzlicher Herkunft gewonnen, die mit natürlichen Zuschlägen von extremer Reinheit vermischt werden. Die Oberfläche mit "soft touch" Effekt sieht ähnlich wie Naturstein aus und findet daher im Badezimmer die ideale Verwendung. Das Material ist durchgehend homogen, wodurch Beschädigungen leicht behaarbar sind.



3) **Exmar**  
Mischung aus Kunstharz und Quarzmehl. Die Oberfläche ist weißer, satiniertes Aussehen ist seidig, warm und angenehm anzufassen. Die Verwendung von Exmar für die Herstellung von Badewannen ist ideal, da das Material die Fähigkeit besitzt, die Wärme des Wassers langfristig zu speichern.

4) **Solid surface**  
Kompaktes und nicht poröses Material, bestehend aus 1/3 Acrylharz und 2/3 Aluminiumhydroxid, einem natürlichen Material, mit dem viele Personen täglich in Kontakt kommen, da es zum Beispiel eine wichtige Komponente der Zahncreme darstellt.

5) **Ceramilux®**  
Verbundmaterial aus natürlichen Mineralien (Kalziumkarbonate und Aluminiumhydrate) und Polyesterharz; mit gelcoat-Überzug auf der Basis von Iso-Neopentyl-Polyester. Ceramilux® ist ein nicht poröses Material, resistent gegenüber Temperaturschwankungen, Kratzer und Abreibung.

6) **Parapan®**  
Parapan®, ein Produkt auf akrylischer Basis, präsentiert sich als monolithisches, glänzendes, massives und einheitlich durchgefärbtes Material. Ökologisch, frei von Lösungsmitteln, 100% recyclefähig, zeitbeständig, mit UV-resistenten Farben. Dank seiner akrylischen Basis ist Parapan® wasserfest, leicht instandzuhalten und besonders geeignet für die Verwendung in feuchten Ambienten wie das Bad.

7) **Polyäthylen**  
Polyäthylen gehört zur Familie der vom Monomer Äthylen abgeleiteten Polymere. Es ist das verbreitetste

plastische Material mit vielfältigen Verwendungsmöglichkeiten. Die Möglichkeit zur plastischen Modellierung des Objektes, seine Farbbarkeit, die Möglichkeit der Oberflächengestaltung, seine Leichtigkeit und nicht zuletzt seine Recyclefähigkeit machen Polyäthylen zu einem für die Anwendungen der Agape-Produktion geeigneten Material.

8) **Exacril**  
Exacril ist ein zur Beschichtung verwendetes Metacrylat mit glänzender Oberfläche (100 Spiegelgloss), als Alternative zum Hochglanzlack entwickelt. Seine große Stärke von 1,4 mm erlaubt Verklebungen auch der Kanten von größter Haltbarkeit und ermöglicht das Ausbessern eventueller Kratzer. Die glänzende Oberfläche ist zeitbeständig, behält ihre Brillanz und verformt sich nicht, ist hitzeresistent, wasserdicht und nicht absorbierend. Ein ungiftiges und ökologisches Produkt.

9) **Silikongummi**  
Silikongummi ist ein Polymer-Elastomer, welches Silikon- und Sauerstoffatome enthält. Die Mischung ist stabil und irreversibel, die mechanischen und elastischen Eigenschaften des Materials bleiben in großen Temperaturintervallen unverändert. Besondere Charakteristika des Silikongummis sind seine Weichheit, seine absolute Ungiftigkeit und homogene Farbgebung. Qualitäten die ideal für Anwendungsbereiche sind, bei denen das Material in direkten Kontakt mit dem Körper und Wasser kommt. Dank seiner Flexibilität lassen sich entstehende Kalkablagerungen leicht entfernen.

10) **Keramik**  
Masse aus tonhaltigen Substanzen mit kompakter Struktur, die modelliert und danach durch Brennprozesse gehärtet wird, die die Verglasungsprozesse der Oberfläche garantieren; von beachtlicher mechanischer und elektrischer Widerstandsfähigkeit.

11) **Marmor**  
Kristallisiertes und kompaktes Kalkgestein. Die Agape-Produktion verwendet z.Zt. weißen Carraramarmor in satiniertes Aussehen. Die Waschbecken werden aus miteinander verklebten Platten hergestellt oder direkt aus dem Block gehauen.

12) **Edelstahl**  
Der Begriff rostfreier Stahl (oder Inox bzw. Edelstahl) bezeichnet allgemein die Stähle mit hohem Legierungsanteil, die Chrom und andere Legierungselemente enthalten, die ihre Widerstandsfähigkeit gegen Korrosion erhöhen. Material von weitaus größerer Resistenz, Härte und Elastizität als einfaches Eisen. Die Oberflächen der Agape-Produkte aus Edelstahl werden poliert oder satiniert.

13) **Aluminium**  
Aluminium ist ein weiches, leichtes Metall von silbergrauer Farbe durch die Oxidschicht, die sich im Kontakt mit Luft sehr schnell bildet. Es ist überaus witterungsbeständig und benötigt daher keinen Schutzanstrich, kann aber dennoch unterschiedlichsten Veredelungsprozessen der Oberfläche unterzogen werden, wie Lackierungen oder Eloxal-Verfahren mit Farben. Aluminium ist nicht magnetisch, nicht toxisch und nicht entflammbar.

14) **Messing**  
Der Name Messing bezeichnet eine Legierung aus Kupfer und Zink, die zur Familie der Bronzen gehört. Dank seiner Widerstandsfähigkeit und Bearbeitbarkeit ein sehr nützliches Metall. Die Oberflächen der Agape-Produkte aus Messing werden glänzend oder satiniert verchromt.

15) **Kristallglas**  
Hauptsächlich aus Silikaten bestehend, hergestellt durch das Schmelzen von Silikatsand mit Oxyden und Carbonaten. Dank seiner perfekten Transparenz, der Unveränderlichkeit und der Kapazität auf veränderliche Weise auf Lichteinflüsse zu reagieren, findet Kristallglas besonders Anwendung in Verbindung mit den anderen Materialien, die für die Agape-Produkte verwendet werden. Die Verbindung zwischen den Einzelteilen werden mit Spezialklebern realisiert, die die perfekte Transparenz des Materials nicht beeinflussen.

## Glossaire des matériaux

1) **Bois**  
Le patrimoine technologique de l'industrie navale est d'importance primordiale pour la conception d'éléments en bois destinés à la salle de bain. Le vieillissement exalte les qualités esthétiques du bois tout en augmentant ses prestations

technologiques. Du point de vue esthétique, les aspects les plus fascinants du bois sont liés à son cycle de vie, à son aspect qui change au fil du temps et des saisons et qu'on peut percevoir à travers la transformation lente de sa surface, de ses veines et de sa couleur.

2) **Cristalplant®biobased**  
Cristalplant®biobased est un matériau écodurable issu de matières premières renouvelables d'origine végétale mélangées à des matériaux inertes naturels extrêmement purs. La surface, avec effet « soft touch » a un aspect semblable à la pierre naturelle qui le rend particulièrement adapté à la salle de bain. Le matériau est homogène dans la masse et peut être facilement réparé.



3) **Exmar**  
Résultat de la composition de résine et de poudre de quartz. Sa surface à finition satinée blanche est soyeuse, chaude et agréable au toucher. L'Exmar utilisé dans la production de baignoires est idéal puisqu'il a la capacité de garder longtemps la chaleur de l'eau.

4) **Solid Surface**  
Matériau massif et non poreux, combinant de façon homogène 1/3 de résine acrylique et 2/3 d'hydroxyde d'aluminium, un minéral naturel courant dans la vie quotidienne puisqu'il s'agit, par exemple, d'un des composants essentiels des dentifrices. Complètement atoxique et recyclable. Sa surface est homogène, soyeuse au toucher, durable et facile à entretenir.

5) **Ceramilux®**  
Matériau composite réalisé avec des charges minérales naturelles (carbonates de calcium et hydrates d'aluminium) mélangées à la résine polyester; revêtement avec gelcoat à base de polyester isonéopentylque. Ceramilux® est un matériau non-absorbant, résistant aux écarts de température, aux éraflures et à l'abrasion.

6) **Parapan®**  
Produit à base acrylique, Parapan® est un matériau monolithique, brillant, massif et coloré de façon uniforme. Matériau écologique, sans solvants,

recyclable à 100%, et inaltérable au fil du temps, il est caractérisé par une tenue des couleurs qui résistent aux UV. Grâce à sa base acrylique, Parapan® est imperméable, facile à entretenir et particulièrement adapté à une utilisation en milieu humide comme la salle de bains.

7) **Polyéthylène**  
Le polyéthylène appartient à la famille des polymères dérivés du monomère éthylène. C'est le plastique le plus commun et le plus répandu. La faculté de modeler l'objet, la coloration, la possibilité d'intervenir sur la texture, la légèreté ainsi que la recyclabilité font du polyéthylène un matériau qui s'adapte parfaitement aux applications de la production Agape.

8) **Exacril**  
Exacril est un méthacrylate de revêtement avec surface brillante (100 gloss à miroir) né comme alternative au laqué brillant. La grande épaisseur, 1,4 mm, permet encollages même sur les chants avec défauts infinitésimaux et le fait restaurable à possibles éraflures. La surface brillante est résistante dans le temps, elle ne perd pas de brillant et elle ne se déforme pas, elle résiste à la chaleur, est imperméable et elle ne absorbe pas. Il est un produit atoxique et écologique.

9) **Caoutchouc de silicone**  
Le caoutchouc de silicone est un polymère élastomère contenant des atomes de silicium et d'oxygène. Ce composé est stable et irréversible, ses propriétés mécaniques et élastiques ne subissent aucun changement, même en présence de variations de températures élevées. Les caractéristiques principales du caoutchouc de silicone sont la souplesse, la complète atoxicité et la coloration pure: des qualités idéales pour réaliser des produits entrant en contact direct avec le corps et l'eau. Sa flexibilité permet d'éliminer facilement le calcaire qui se dépose à l'usage.

10) **Céramique**  
Pâte à base de substances argileuses à structure compacte, modelée et consolidée à travers des processus de cuisson qui garantissent la vitrification de sa surface; elle est dotée d'une résistance mécanique et électrique considérable.

11) **Marbre**  
Roche calcaire cristallisée et compacte. Agape utilise actuellement le marbre blanc de Carrare à finition satinée. Les lavabos sont réalisés avec des plaques unies par collage ou bien sont creusés directement dans le bloc.

12) **Acier inox**  
Le terme acier inoxydable (ou inox) indique généralement les aciers fortement alliés contenant du chrome et d'autres liants qui augmentent la résistance à la corrosion. L'acier inox est doté de qualités comme la résistance, la dureté et l'élasticité supérieures à celles du fer simple. Les produits Agape en acier inox sont soumis à des traitements superficiels de polissage ou de satinage.

13) **Aluminium**  
L'aluminium est un métal malléable et léger de couleur argent vif, due à une fine couche d'oxydation qui se forme rapidement quand il est exposé à l'air. Il est extrêmement résistant à la corrosion atmosphérique : c'est la raison pour laquelle il n'a pas besoin de peinture de protection, mais peut être traité avec une ample gamme de revêtements, des peintures aux anodisations colorées. L'aluminium est amagnétique, non toxique et ininflammable.

14) **Laiton**  
Le terme laiton indique un alliage de cuivre et de zinc appartenant à la grande famille du bronze. C'est un métal très utile compte tenu de sa résistance et de son usinabilité. Les produits Agape en acier inox sont soumis à des traitements superficiels de chromage poli ou de chromage satiné.

15) **Cristal**  
Composé essentiellement de silicates, le cristal est le résultat de la fusion de sable de silice combiné avec des oxydes et des carbonates. Grâce à sa transparence parfaite, à son inaltérabilité et à sa capacité de réagir à la lumière de façon changeante, le cristal se combine parfaitement avec les autres matériaux utilisés dans la fabrication des produits Agape. Les jonctions entre les différentes pièces sont effectuées avec des colles spéciales qui garantissent une transparence hors pair et une continuité impeccable du matériau.

## Glosario de materiales

### 1) Madera

El patrimonio tecnológico de la industria naval es un elemento fundamental en el proyecto de componentes de madera para el baño. El envejecimiento exalta las cualidades estéticas naturales de la madera y aumenta las prestaciones tecnológicas. Del punto de vista estético, lo que más gusta de la madera es su ciclo de vida, el aspecto cambiante que adquiere con el tiempo y las estaciones, observado a través de la lenta transformación de las superficies, de los veteados y del color.

### 2) Cristalplant®biobased

Cristalplant®biobased es un material ecosostenible que deriva de materias primas resinosas de origen vegetal, mezcladas con materiales inertes naturales de absoluta pureza. La superficie, suave al tacto, presenta un aspecto similar al de la piedra natural que la hace particularmente indicada para usar en el cuarto de baño. El espesor del material es homogéneo y es muy sencillo mantenerlo siempre como nuevo.



### 3) Exmar

Material obtenido de la composición de resina y polvo de cuarzo. La superficie, de acabado satinado blanco, es sedosa, cálida y agradable al tacto. El Exmar es ideal para la fabricación de bañeras gracias a su capacidad de conservar el calor del agua por más tiempo.

### 4) Solid surface

Material compacto y no poroso, compuesto en modo homogéneo por un tercio de resina acrílica y dos tercios de hidróxido de aluminio, un mineral natural con el que muchas personas entran en contacto diariamente, ya que constituye, por ejemplo, un componente importante de las pastas dentífricas. Completamente atóxico y reciclable. La superficie se presenta homogénea, sedosa al tacto, duradera y fácil de limpiar.

### 5) Ceramilux®

Material compuesto por cargas minerales naturales (carbonatos de calcio e hidratos de aluminio) mezcladas con resina poliéster, recubierto con gelcoat a base de

poliéster iso/neopentil. Ceramilux® es un material no absorbente, resistente a los cambios térmicos, a las rayaduras y a la abrasión.

### 6) Parapan®

Producto de base acrílica, el Parapan® se presenta como un material monolítico, brillante, macizo y de color uniforme. Material ecológico, sin solventes, reciclable al 100%, inalterable en el tiempo, los colores resultan resistentes a los rayos UV. Gracias a su base acrílica, el Parapan® es impermeable, fácil de mantener y particularmente idóneo para su uso en ambientes húmedos como el cuarto de baño.

### 7) Polietileno

El Polietileno forma parte de la familia de los polímeros derivados del monómero de etileno. Es la materia plástica más común y de amplia difusión. La posibilidad de modelado plástico del objeto, la coloración, la intervención en la textura, la ligereza, así como su facilidad de reciclaje, hacen del polietileno un material apto para fabricar los productos Agape.

### 8) Exacril

Exacril es un metacrilato de revestimiento con superficie brillante (100 gloss efecto espejo) que se ha creado como alternativa al lacado brillo. El gran espesor, 1,4 mm, hace que pueda pegarse también a los bordes con defectos infinitesimales y restaurarse en caso de rayaduras ocasionales. La superficie es duradera, no pierde brillo y no se deforma, resiste al calor, es impermeable y no es porosa. Es un producto atóxico y ecológico.

### 9) Goma silicónica

La goma silicónica es un polímero elastómero que contiene átomos de silicio y de oxígeno. El compuesto es estable e indeformable, las propiedades mecánicas y elásticas del material no sufren variaciones frente a intervalos de temperaturas elevadas. Las características peculiares de la goma silicónica son la suavidad, la completa atoxicidad y la coloración pura; estas cualidades favorecen una aplicación ideal allí donde el material entra a contacto directo con el cuerpo y con el agua. La flexibilidad permite eliminar fácilmente las sustancias calcáreas que se depositan durante

el uso del producto.

### 10) Cerámica

Pasta de sustancias arcillosas de estructura compacta, modelada y consolidada por medio de procesos de cocción que garantizan los tratamientos de vitrificación de la superficie, de notable resistencia mecánica y eléctrica.

### 11) Mármol

Roca calcárea cristalizada y compacta. En la actualidad, Agape utiliza mármol blanco de Carrara con acabado satinado. Los lavabos se fabrican con planchas unidas mediante encolado o esculpidos en un bloque.

### 12) Acero inoxidable

El término acero inoxidable (o inox), por lo general, describe los aceros de alta aleación que contienen cromo y otros aglomerantes que aumentan la resistencia a la corrosión. Material con cualidades de resistencia, dureza y elasticidad muy superiores respecto al hierro simple. Los productos Agape en acero inoxidable son sometidos a tratamientos superficiales de pulido o satinado.

### 13) Aluminium

El aluminio es un metal suave y ligero, con un color plateado vivaz, debido a una capa sutil de oxidación que se forma rápidamente cuando se expone al aire. Es sumamente resistente a la corrosión atmosférica: por esta razón no requiere ninguna pintura de protección, aunque puede ser tratado igualmente con una amplia gama de revestimientos, desde las lacas hasta las anodizaciones coloreadas. El aluminio es no magnético, no tóxico y no inflamable.

### 14) Latón

Con el nombre de latón se denomina una aleación de cobre y zinc, que compone la familia más amplia del bronce. Es un metal muy útil, gracias a su resistencia y facilidad de tratamiento. En los productos Agape de latón se aplican tratamientos superficiales de cromado brillo o satinado.

### 15) Cristal

Formado esencialmente por silicatos, se obtiene por fusión de arena silícea con óxidos y carbonatos. Gracias a la transparencia perfecta, a la inalterabilidad y a la capacidad de reaccionar a la luz de manera siempre cambiante, el cristal se utiliza especialmente en las combinaciones con otros materiales que componen la gama de productos Agape. Las uniones entre las partes se realizan con adhesivos especiales que garantizan la perfecta transparencia y la continuidad del material.

### Certificazione / Certification

I prodotti Agape possono contribuire a soddisfare i requisiti dei crediti LEED®. Agape products can contribute to the allocation of LEED® credits. Für die Produkte von Agape können LEED®-Punkte zuerkannt werden. Les produits Agape peuvent contribuer à satisfaire les requis nécessaires pour l'évaluation LEED®. Los productos Agape cumplen con los requisitos exigidos por LEED®.



Agape è socio Green Building Council Italia / Agape is member of the Italian Green Building Council / Agape ist Mitglied des Green Building Council Italien / Agape est membre de Green Building Council Italie / Agape es miembro de Green Building Council Italia

Graphic design: Designwork  
Copywriting: Daniele Varelli  
Translation: StudioIntra  
Photography: Andrea Ferrari,  
Filippo Bamberghi, Studio Haas,  
ContrattiCompany, F2,  
Andrea Gnesato, Luca Marri,  
Giorgio Possenti, Leo Torri,  
Max Zambelli, Marzio Bondavalli  
Collezione tessile: IVANOREDAELLI  
pag. 09, 11, 31, 99, 119  
Colour separation: Lucegroup  
Printed by: EBS Editoriale  
Bortolazzi Stei

Agape srl ©02.2013



Agape srl  
via A. Pitentino, 6 / 46037 Governolo  
Roncoferraro (MN), Italy  
T +39 0376 250311 / F +39 0376 250330  
info@agapedesign.it  
www.agapedesign.it

