



Showrooms

Showrooms in New York, Paris, Milan, Barcelona, London (from June), Singapore, Chongqing, Cairo, Bizerte, Johannesburg, Tarapur.
www.duravit.com/showrooms



Retailer

On site: retailer and sanitary specialist plan and realize your new Duravit bathroom.
www.duravit.com/retailer



Bathroom planner

Just one click away - plan and design your own dream bath online.
www.duravit.com/bathroomplanner



Media

News from the Design- and Duravit-world on Facebook, Instagram, Twitter, Pinterest, YouTube ...

www.duravit.com/media

DURAVIT AG
 Werderstr. 36
 78132 Hornberg
 Germany
 Phone +49 7833 70 0
 Fax +49 7833 70 289
 info@duravit.com
 www.duravit.com



Best.-Nr. 001279/10.09.18.29.5.1 - Printed in Germany - We reserve the right to make technical improvements and enhance the appearance of the products shown.

BADMAGAZIN Edition 07

**BAD
MAGAZIN**

100%
 • DESIGN
 • TECHNOLOGY
 • QUALITY

Nordic origins: Cecilie Manz's Luv bathroom range --- it's what we've been waiting for: Tap fittings from Duravit --- a phenomenal legacy: Zaha Hadid's opus in Dubai --- A fresh breeze for the bathroom: Vero Air --- Craftsmanship: well-made bathroom furniture.



www.duravit.com/livenow

#refresh, #stayclean, #relax, #rejuvenate.

Enjoy.

Colours and surfaces overview

Decor

DuraStyle
Happy D.2 (only 22, 52, 75)
Ketho
L-Cube
Universal consoles
Vero Air/Vero
X-Large

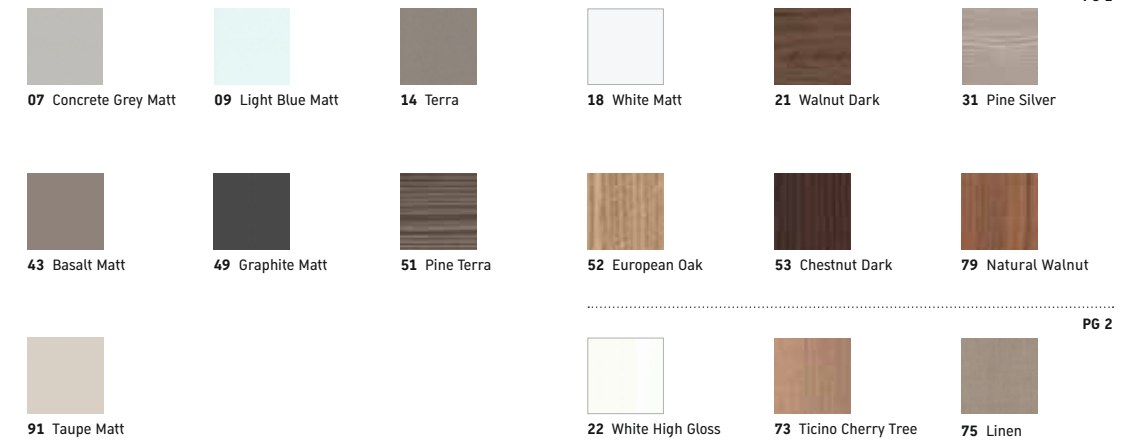

Real wood veneer

Happy D.2 (only 11, 13, 72)
L-Cube
Starck (only 05, 13, 24)
Universal consoles
Vero Air/Vero
X-Large



Lacquer

Cape Cod (only 85)
L-Cube
Luv (only 36, 39, 60, 92, 97, 98)
Starck (only 40, 85)
Universal consoles
Vero Air/Vero
X-Large

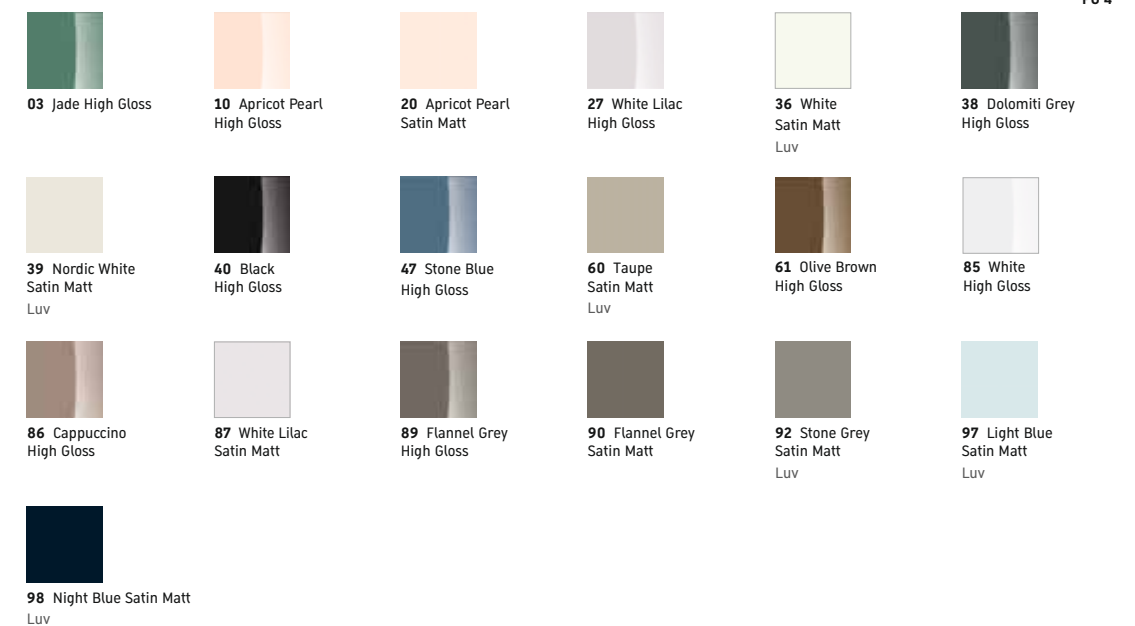

Real wood massive

Cape Cod
DuraStyle (Furniture-Acces. 76, 77)
Luv (only console 77)



Quartz Stone

Luv (only consoles)

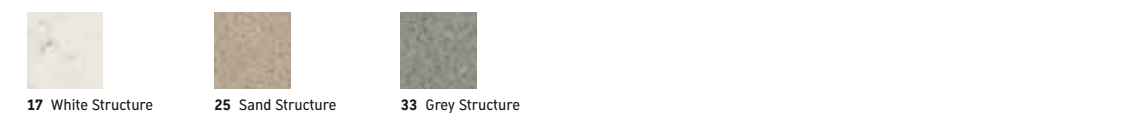



#refresh

Fresh ideas. A clear head. And the energy to start each new day refreshed: all of this awaits us in the bathroom. And the ideas for that come from Duravit.

Relaxation is part of the art of success. And we know that better than anyone, which is why we are always breathing new ideas into a millennia-old ritual. For a relaxing bathroom. For more restful moments. For life in the bathroom. With Duravit.

#relax

Happiness and health are two sides of the same coin. The bathroom is not only a place of relaxation, it also plays an important role in maintaining health. The most private of all rooms. Welcome to the bathroom. Welcome to Duravit.

#stayclean



Reinvent yourself. Design your home exactly as you imagine it. Take your inspiration from all the things that give you strength at home. Live in the moment. With Duravit.

#rejuvenate

The time to start something new. Contemplation of the things that we find soothing in life. The decision to modernize. The best moment? Here and now. With Duravit.

We develop the right interior, sustainable furniture and comfort-enhancing technologies for anyone who wants to breathe life into their bathroom. Some of this can be found in the new Badmagazin, more on the internet or ask your bathroom planner, architect or Duravit dealer.

Duravit. Living bathrooms.
The original, since 1817.



Subjects

012 No Limits

Creative world: ideas, design.

038 New

Brave new (bathroom) world.

056 DuraCeram®

Extraordinary: refined forms thanks to new technology.

058 Clear edge

About design and details.

CECILIE MANZ
The designer
behind Luv

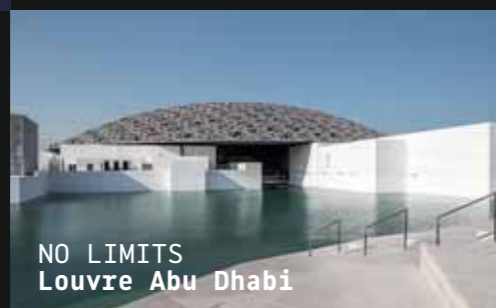

146 Toilet comfort and hygiene

Technologies and innovations for ultra-clean toilets: SensoWash®, Duravit Rimless® and HygieneGlaze 2.0.

158 Bathtubs, showers and saunas

Everything that refreshes and regenerates us.

180 Craftsmanship

The magic is in the details: Bathroom furniture and mirrors.

194 Colours and surfaces

For a very personal bathroom.

Series & Products

132 **1930 Series**
080 **Cape Cod** series
128 **D-Code** series
124 **Darling New** series
050 **DuraSquare** series
136 **DuraStyle** series
120 **Happy D.2** series
110 **Ketho** bathroom furniture
104 **L-Cube** bathroom furniture
040 **Luv** series
086 **ME by Starck** series
112 **P3 Comforts** series
096 **Starck 1** series
098 **Starck 2** series
100 **Starck 3** series
116 **Vero** series, bathroom furniture
060 **Vero Air** series
126 **X-Large** bathroom furniture

144 Washbowls **Architec/Foster/Scola**

130 Accessories

069 Faucets **C.1/B.1/B.2**

176 Faucets **Bathing/Showers**

146 **SensoWash®**

152 **Duravit Rimless®**

154 **HygieneGlaze 2.0**

156 One-, two-piece toilets

160 Bathtubs

165 Light, whirlpool technology

164 Bathtub covers

168 **Stonetto** shower trays

170 **P3 Comforts** shower trays

172 **Starck Slimline** shower trays

173 **Duraplan** shower trays

174 **OpenSpace/OpenSpace B**

076 **Shower + Bath**

178 **Inipi/Inipi B** sauna

190 Mirrors, Mirror cabinets

186 Universal consoles



Luv

NEW
DuraSquare



NO LIMITS

The blue Duravit lettering with the wood grouse is now recognized around the world. It can be found on ceramics, furniture and bathtubs that meet the highest standards of quality, technology and design. Luxurious hotels, imposing concert halls, idyllic chalets – the masterpieces that we're presenting to you here have one thing in common: the blue wood grouse.



OPUS TOWER DUBAI

Zaha Hadid was a master of organic architecture and the first woman to be awarded the coveted Pritzker Prize, the Nobel Prize of architecture. One of her last and most remarkable designs is the Opus Tower in Dubai. Starck 1 urinals, Starck 2 toilets and Starck 3 handrinse basins make a clear statement for durable and sustainable design.

www.duravit.com/opusdubai

© The Opus by Zaha Hadid

CHALET SWITZERLAND

Disused barns are usually located in idyllic spots and have interesting layouts. Architects have now rediscovered their charm. Whilst the interiors are converted into modern lofts, hardly anything changes on the outside. Savioz Fabrizzi Architects specialize in this process. This former barn was transformed into a MODERN vacation apartment. In the bathroom: Vero washbasins.

www.duravit.com/chaletswitzerland



© Thomas Jantscher



© Henrik Stenberg

THE KRANE COPENHAGEN

In Copenhagen's harbour, Nordic straightness meets luxurious design. The Danish architects firm Argency has transformed a former coal crane into an elegant one-room design hotel. Aboard "The Krane" are two Cape Cod bathtubs - with a premium view that extends over Copenhagen's port and out to sea.

www.duravit.com/kranecopenhagen



LOUVRE ABU DHABI

The new emblem of the United Arab Emirates announces a modern Abu Dhabi. It is right on the coast, covered by a dome-shaped steel mesh. Masterpieces by Bellini, da Vinci and Gauguin are exhibited in the museum. Another classic by a French master can be found in the bathrooms - Starck 3 toilets by Philippe Starck and Duravit. www.duravit.com/louvreabudhabi

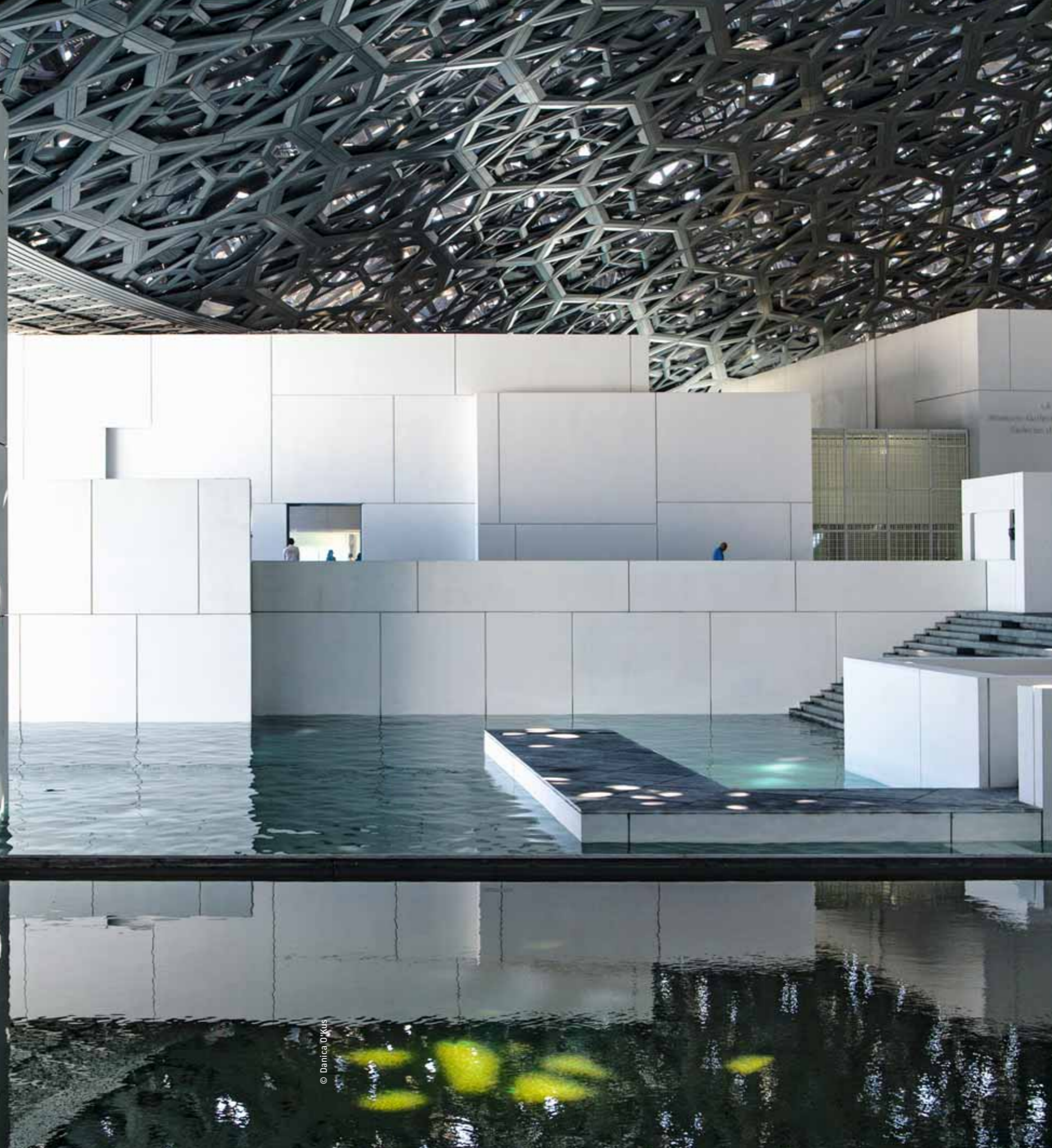

© Danica O'Kus

MORPHEUS HOTEL MACAU

As one of her last works, architecture icon Zaha Hadid erected a unique monument. The 40-storey luxury hotel has the effect of an organic sculpture that is both curious-looking but at the same time seems to have been tailor made for the legendary "City of Dreams".

www.duravit.com/morpheusmacau

FDREAMS

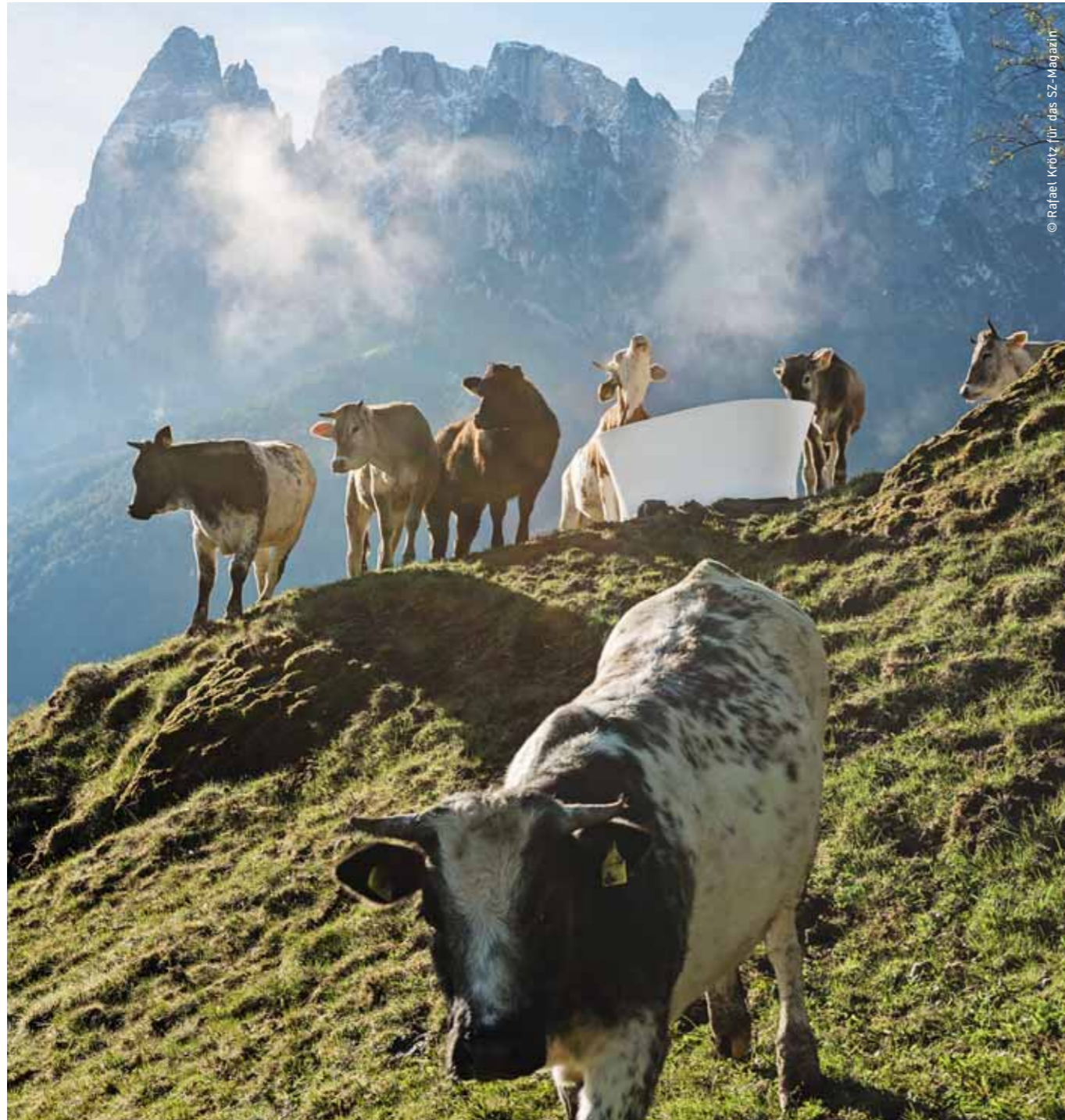

© Rafael Krötz für das SZ-Magazin

ON THE MOUNTAIN PASTURE SOUTH TYROL

On the mountain pasture of the Mesner farm in Völs am Schlern, the cows are delighted with their new bathtub, even if it has only been put in place for a short time. Süddeutsche Zeitung.

www.duravit.com/almsouthtyrol



© Bas Princen

No limits

FONDAZIONE PRADA MILAN

It took three kilos of gold leaf to make the tower's façade gleam. In the interior, too, the architects from the Office for Metropolitan Architecture only chose the very best: Starck 3 and Architec toilets by Duravit.

www.duravit.com/pradamilano



Harald Gründl / E00S

Gernot Bohmann / E00S

Martin Bergmann / E00S

Tom Schönherr / Phoenix Design

Andreas Haug / Phoenix Design

Michael Sieger / sieger design

Prof. Frank Huster

David Nelson / Foster&Partners

Christian Werner

Matteo Thun

Antonio Rodriguez

Kurt Merki Jr.

Philippe Starck

Cecilie Manz

Dieter Sieger / sieger design

Christian Sieger / sieger design

THE DURAVIT DESIGNERS

Duravit's designers are as diverse as its product ranges. Whether simple or extravagant - what unites them is their uniqueness.



GARAGEN LOFT AMSTERDAM

Cars and motorcycles have given way to vintage furniture in this former garage from the 1950s. The workbench was retained, albeit Designer James van der Velden quickly repurposed it as a stand for a Vero above-counter basin.

www.duravit.com/loftamsterdam

SCHUSTERBAUERHAUS MUNICH

Architect Peter Haimerl transformed the listed building from the 18th century into a residential house for two families. Here, cool concrete and modern architecture combine with warm wood and ancient structures. The timeless Vero range slots perfectly into this seemingly contradictory environment.

www.duravit.com/schusterhausmunich



© EUROBODEN für Stefan F. Högelmeier

© Valentine Harmsen für BRICKS

SAHYADRI MOUNTAIN RESORT INDIA

The Sahyadri Mountain Resort in the Kannan-Devan Hills offers pure relaxation. The breathtaking nature there is not just something to behold from the terrace, but can also be optimally utilized. The architects used volcanic rock in the build and made sure that plenty of natural light could stream in. In the bathroom this light again falls on ancient rock - a washbasin from the successful Vero range from Duravit.

www.duravit.com/sahyadriresort



© Shantanu Patil

MONS INTERNATIONAL CONGRESS XPERIENCE MONS

The architectural works of Daniel Libeskind are the product of impulses and emotions. The futuristic congress centre in Belgium stimulates the imagination. Washbasins and toilets were created by another world-renowned designer: Philippe Starck.

www.duravit.com/congressmons



© Huftoy + Crow

PURE SALT GARONDA PALMA

The five-star hotel is part of the Mallorcan urban beach trend: a contrast to the bustle of Palma is created directly on the sandy beach. At the same time, the town is just a stone's throw away. The Happy D.2 bathtub from Duravit provides relaxation with a sea view.

www.duravit.com/puresaltpalma



© Joan Luis Coll



© AFP - C. Platiau

PHILHARMONIE DE PARIS

Architect Jean Nouvel describes the unusual arrangement of the balconies as "immaterial draped sheets of music and light". The building is France's international centre for music. Duravit calls the tune with Vero, Starck 1 and Starck 3 - at least in the bathrooms.

www.duravit.com/philharmonieparis

© Undine Pröhl

CASA FAYETTE GUADALAJARA

The city's first design hotel is an old villa dating from the 1940s. The architects of Estudio5 retained the house's special look and used quality materials such as marble and wood in construction. Duravit's 1930 range was the perfect solution for the bathroom, which retains its classical elegance.

www.duravit.com/casafayette



© Joe Fletcher Photography

OAK PASS MAIN HOUSE BEVERLY HILLS

The architectural jewel made from glass, concrete and steel is located in the heart of nature. It's easy to forget that the bustling Sunset Strip is just a few miles away. From the Vero washbasin you can take in parts of the 3.5-hectare property.

www.duravit.com/oakpasshouse

ELBPHILHARMONIE HAMBURG

A house of music that stands between heaven and earth, harbour and city. The unmistakable building has three concert halls, as well as a hotel, restaurants and private apartments. In the sanitary facilities, Scola and Starck 3 by Duravit combine classical design with a modern feel.

www.duravit.com/elbphilharmonie

© Mark Seelen

120 ALLEN STREET, LOWER EASTSIDE MANHATTAN

Given the shortage of space in Manhattan, bathrooms often have to be designed to squeeze in wherever they can. Architects Grzywinski + Pons have pulled this off in style. Equipped with Scola washbasin, these rooms afford a degree of luxury even where space is at a premium.

www.duravit.com/120allenstreetmanhattan



© Nicholas Wortley

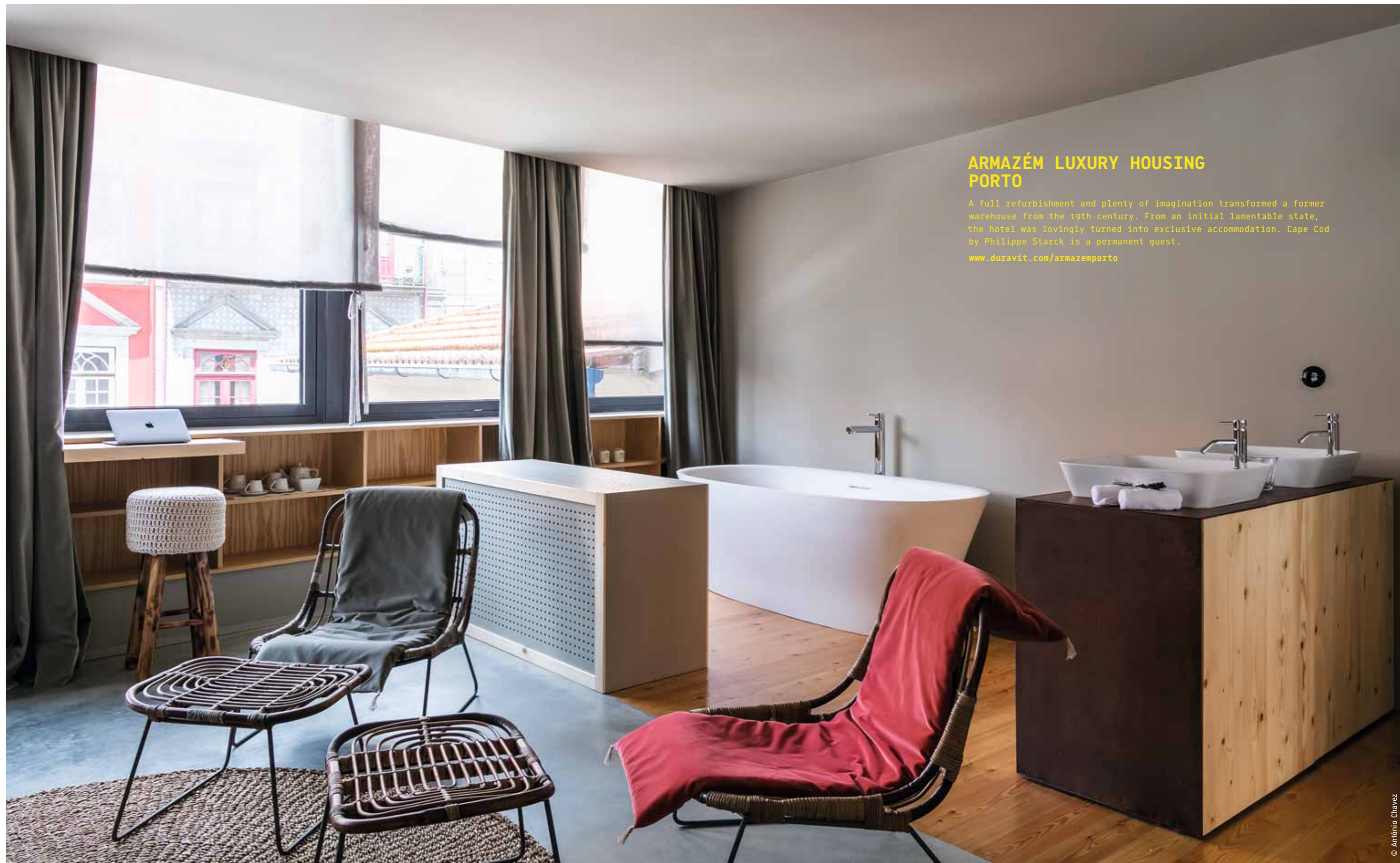

ARMAZÉM LUXURY HOUSING PORTO

A full refurbishment and plenty of imagination transformed a former warehouse from the 19th century. From an initial lamentable state, the hotel was lovingly turned into exclusive accommodation. Cape Cod by Philippe Starck is a permanent guest.

www.duravit.com/armazemporto

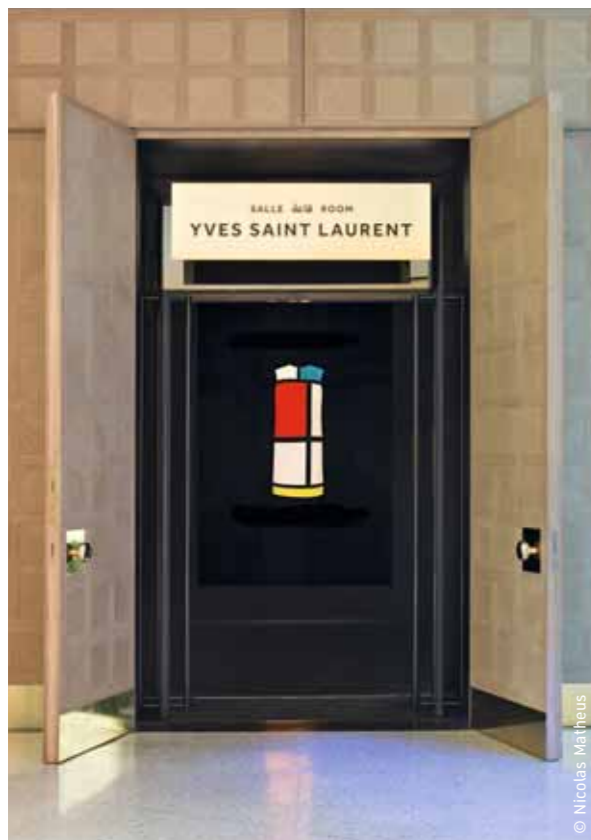

© Nicolas Mathéus

YVES SAINT LAURENT MUSEUM MARRAKESH

The French fashion designer had a special passion for the Jardin Majorelle garden in Morocco. It is fitting that his legacy is presented directly next to the richly coloured artwork of cactuses, palm trees and water lilies. With their harmonious circular form, the wall-mounted toilets from the Darling New range by sieger design are made for the building.
www.duravit.com/yslmarakesh



© Nicolas Mathéus

© Filippo Romano



FELTRINELLI PORTA VOLTA MILAN

Extravagant, influential and a little odd - that's one way of describing Giangiacomo Feltrinelli. The publishing-company founder was a close friend of Che Guevara and one of the extraordinary figures of the Italian post-war years. An equally special building honours his memory. Duravit, too, immortalized itself in this special project - with bathrooms from the Darling New range.

www.duravit.com/feltrinellimilan

NEW



- 40 Luv
- 50 DuraSquare
- 56 DuraCeram®
- 60 Vero Air
- 68 Faucets
- 76 Shower + Bath



Luv blends Nordic purism with timeless, emotional elegance.



00 White



26 White Satin Matt



23 Grey Satin Matt



21 Sand Satin Matt

Luv

Design Cecilie Manz

Bathroom ceramics all in White High Gloss, alternatively the external surfaces of the above-counter basins in White, Grey or Sand with a satin matt finish, all wash bowls made from DuraCeram®, matching toilets from the ME by Starck series

Bathroom furniture Six surfaces in matt lacquer, console panels made from quartz or solid wood

Bathtubs made from the innovative material DuraSolid®, available as a freestanding variant, back-to-wall and corner version

Interesting details Matt finishes combined with above-counter basins in satin matt produce a refined, pure effect

Guiding principle Nordic purism, timeless elegance, finely nuanced tones

Gentle forms follow a stringent geometry. An unusual range in a new design language that can be interpreted in a highly individual manner – minimalist or elegant. There's plenty to choose from: three different above-counter basins, vanity units in various widths and colours, and console panels

made of quartz or solid American Walnut to combine as you please. The striking design of the bathtubs reflects the design of the washbowls – an oval basic form, gently curving lines, generously-proportioned interior and surprisingly thin bathtub edge, seamlessly manufactured from DuraSolid®.



80 cm



60 cm



42 cm

The Luv above-counter basins come in three sizes: with and without a raised tap platform, 80 and 60 cm wide, and with a tap hole platform to the right or left, 42 cm wide. The outer surfaces are available in White, Grey or Sand in a satin matt finish as well as glazed in White. For a harmonious look: the ceramic drain cover. Matching tap fittings: C.1



Nordic purism with an emotional touch: inviting and generously-proportioned with a double washing area in Taupe Satin Matt, a console panel in Quartz White Structure and extra-high mirror (120 cm). The glare-free LED lighting at the top edge of the mirror guarantees optimum illumination of at least 300 lux. And a bath made from DuraSolid® with C.1 tap fittings to match.

The vanity unit is 138.8 cm wide. Finished in Nordic White Satin Matt with a console panel in Quartz Stone Sand Structure, incl. a drawer and a pull-out compartment.



36 White Satin Matt



39 Nordic White Satin Matt



60 Taupe Satin Matt

The console tables are available in the widths 68.8, 138.8 and 178.8 cm in six different colours in matt lacquer as well as with individually combinable console panels in Quartz Stone White, Grey, Sand or solid American Walnut. The pull-out compartments and drawers offer plenty of storage – with gentle, handle-free opening, tip-on technology and self-closing action.



92 Stone Grey Satin Matt



97 Light Blue Satin Matt



98 Night Blue Satin Matt

Pleasantly warm feel, matt look thanks to DuraSolid®: The bathtubs are available as a freestanding version (180x85 cm), as a back-to-wall (180x95 cm) and left or right corner version (185x95 cm). Back-to-wall and corner version are also available with integrated Air-System that is switched on and off via a flat, discreet button with one-touch operation.



The mirror: with touchless control panel used to activate the LED lighting, dim function and the mirror heating.



Alternative combination: in Stone Grey Satin Matt, console panel in Quartz Stone White Structure – one pull-out compartment.



Designer Cecilie Manz' original vision for Luv was a bowl filled with water standing on a table.

The console table is 178.8 cm wide either for two washing areas or an asymmetric single washing area - here in the combination Taupe Satin Matt with a matching console panel in solid American Walnut.

Luv by Cecilie Manz has opened a new chapter in Scandinavian design: her elegant, Nordic-inspired bathroom range for Duravit has the potential to become a modern classic from the start.



Designer of the year 2018



In 2017 Cecilie Manz was named "designer of the year" in the renowned Danish living magazine "BO BEDRE".

Ms. Manz, you are well-known for your simple, timeless designs. Which do you like yourself?

Chairs are a good example, because we can all directly feel their design quality – after all, we spend many hours a day sitting on them. I have eight completely different chairs around the desk in my studio and each has proven its timelessness one way or another.

Do you try a different chair out every day?

No. I usually sit on the same one, a classic chair by Kaare Klint, the grandfather of Danish design. It's not actually my style, but I inherited it from my grandmother and used to sit on it as a child. I like that.

How do you go about designing a classic? What does design need to be to outlast eras and fashions?

You can't design timelessness, because only time will tell which product and which design has the staying power for people to still regard it as a thing of beauty after many years. There's no sure-fire formula for that. So, as a designer all you can do is to treat each design task as a stand-alone project and give it your best shot.

How can we envisage you going about these tasks?

My design process always starts with a roll of drawing paper, my favourite ruler and a pen. Sometimes I start with a task I set myself, sometimes I have a 20-page briefing and I ask myself: What is the personality of this product? What's the basic idea inherent within it? What's at its core? And then I start to draw.

Like a bowl of water on the table: Cecilie Manz outlines Luv.



"There's a piece of nature within Luv"

Where do such ideas originate? How and where do you get your inspiration?

That's both easy and difficult to answer, because I'm like a sponge that's constantly absorbing and filtering textures, surfaces, colours and shapes. And some of this finds its way into my designs sooner or later.

You have already designed tables, speakers, lights and fabrics and have won many renowned awards for them. However, Luv is your first design with ceramics. What appealed to you about the task?

I like to work for and with companies who are specialists in a given area, and Duravit is a proven expert in bathroom ceramics. What's more, ceramics are part of my personal history, because my parents ran a small porcelain factory in the countryside where they produced household ceramics and handicrafts. So I grew up among potters' wheels and kilns and would earn part of my pocket money by helping out in the factory.

Is there anything in Luv that you have picked up from your parents?

I spent many hours next to my father watching him try to create a perfect curve in a plaster mould. And it really did have to be perfect – after all, the mould was ultimately used to mould many, many bowls. And today it's exactly the same for me: the perfect shape is something I spend a long time getting right. Although I do have another inspiration: see this pebble that has been polished into a round shape by the tides and the sand? Nature has given it an exceptionally aesthetic shape, and there's also a piece of that in Luv.

It really is beautiful. Where is this pebble from?

From the Baltic coast. We have a small holiday home by the sea, and when I walk along the beach I can't help but collect pebbles that have been shaped by nature. I know a lot of other people who do the same because they simply cannot resist this natural beauty. And that's the precise feeling I wanted to convey with Luv.

Cecilie's world



"Workshop Chair" for Muuto



"Caravaggio" lamp for Lightyears



"Spectra" vase series for Holmegaard



"Compile" shelves for Muuto



"Etherware, Light Tray" candle-holder for Fritz Hansen Objects



"Pouf" for Fritz Hansen Objects

Today designs by the Danish designer form part of the collections of MoMa (New York) and Design Museum (Copenhagen). However, the main destination for her calm Scandinavian designs is increasingly private households around the globe.

CECILIE MANZ

Currently probably the most popular designer in Denmark, Cecilie Manz was born in 1972 in Odsherred, where her parents owned a ceramic workshop. Art and design were therefore her constant companions as a child.

In 1992 she began to study at the Royal Danish Academy of Fine Arts - The School of Design and she also attended the University of Art and Design in Helsinki as an exchange student.

In 1998, a year after graduating Cecilie Manz set up her own design studio. Since then she has designed lamps, vases, audio equipment, indoor and outdoor furniture, accessories for the kitchen and living room and worked for renowned companies such as Bang & Olufsen, Fritz Hansen, Fredericia Furniture, Nils Holger Moormann, Lightyears, Georg Jensen, Iittala, Muuto and Gloster.

Products by Cecilie Manz are sold around the world and have won numerous design prizes. Her works can be found in the permanent exhibitions in the MoMa (New York) and the Design Museum Denmark (Copenhagen).

In 2017 she was named "Designer of the year" in Denmark.



"Beoplay A1" bluetooth speaker for B&O



Fusing the rectangle and circle. Architectural, rectangular design with striking precision. Straight-lined and organic.

DuraSquare

Design Duravit

Bathroom ceramics in White made from DuraCeram®, with matching toilets from the Vero Air series

Bathroom furniture Combinable with all consoles, such as L-Cube, alternatively the wall-mounted or floor-standing metal frame, in Chrome or Matt Black with glass shelves in seven different colours

Bathtubs with seamless paneling made from DuraSolid®, available as freestanding version, back-to-wall, corner and built-in version (optionally with Air-System)

Interesting details Extremely precise edges, striking contours

Guiding principle Fusion of rectangle and circle

For lateral thinkers and aesthetes. Pared down and finished to a high quality: the design of the new architectural series combines the precise edges of the rectangular outer form with the organic flow of the inner contours. The washbasin and bathtub are made from the innovative, sustainable materials DuraCeram® and DuraSolid®. DuraCeram® enables a previously unattained level

of precision in the design of ceramic washbasins and above-counter basins. Further outstanding features of DuraSolid® are its warm touch and elegant matt aesthetics on the bathtubs. Distinctively masculine or elegantly feminine? By fusing the rectangle and circle, contradictions are resolved and a uniform, durable and contemporary whole is created.



Floor-standing single lever bath mixer C.1

Stylish

The generously-proportioned washbasin with ceramic drain cover fits perfectly into a contemporary bathroom architecture that has a mix of styles. The classic three-hole tap fitting is part of the C.1 range. The washbasin width of 100 cm also permits a solution for two single-lever mixers. Matching consoles are available from the L-Cube furniture programme.

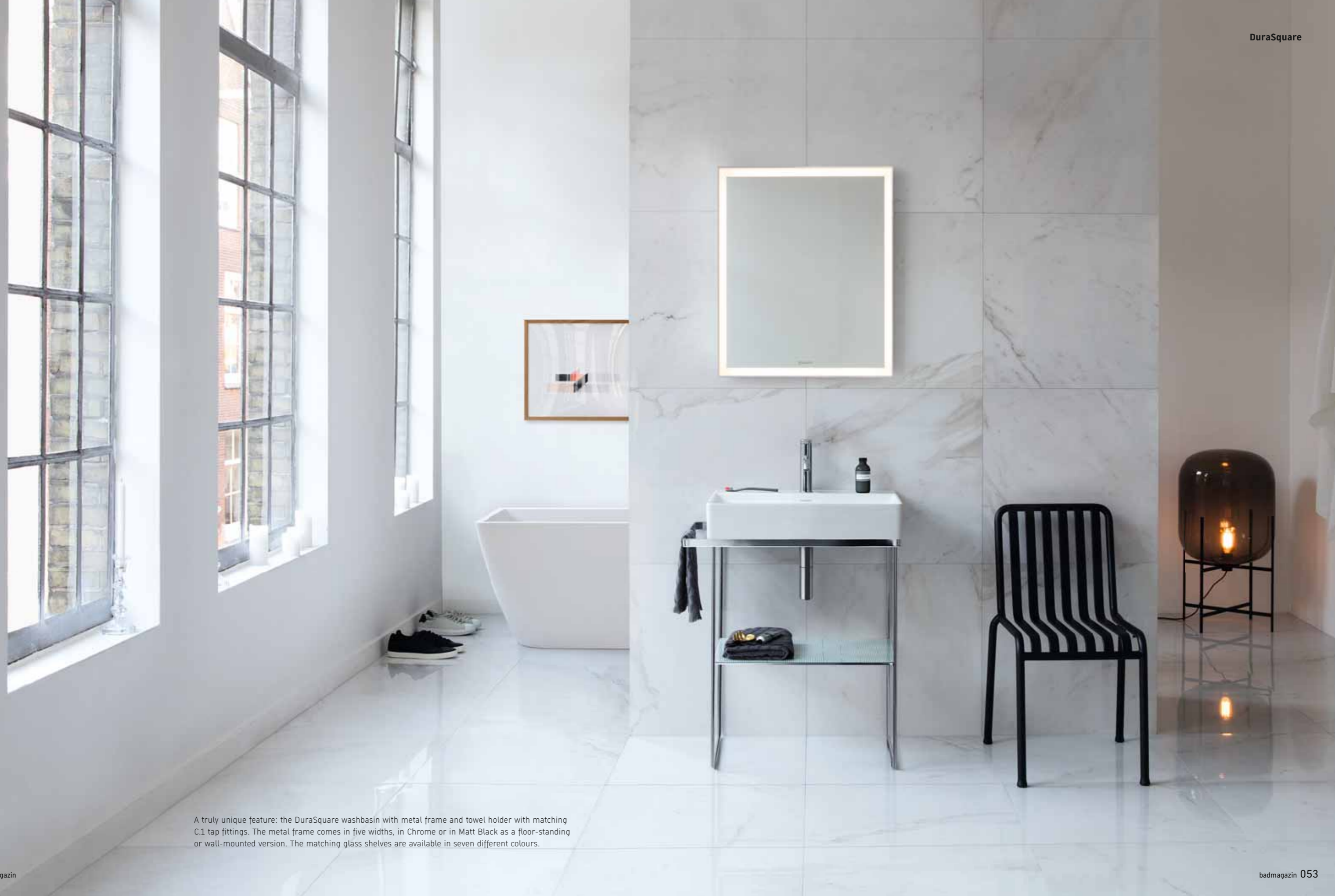

A truly unique feature: the DuraSquare washbasin with metal frame and towel holder with matching C.1 tap fittings. The metal frame comes in five widths, in Chrome or in Matt Black as a floor-standing or wall-mounted version. The matching glass shelves are available in seven different colours.

Glass inserts



82 Cubic Line



83 White



84 Black



85 Jade



86 Apricot Pearl



87 Flannel Grey



88 Stone Blue

The above-counter basin with a glazed back and separate tap platform can be positioned directly in front of a mirror. Series C.1 offers matching tap-fitting solutions, whether as a single lever basin mixer or a wall-mounted fitting.



The unusual form of DuraSquare can be seen clearly in the minimalist ceramic washbasin (optional widths of 100, 80 or 60 cm). The innovative material DuraCeram® enables extremely thin edges (8 mm for washbasins and just 5 mm for above-counter basins) to be manufactured precisely. The smooth inner basin forms an aesthetic contrast to the exact geometry of the series.

Sustainable in terms of design and material

The bathtubs are made from the innovative cast mineral material DuraSolid® and have a surprisingly warm, pleasant feel. They are available as a free-standing (185x85 cm) or as a built-in, back-to-wall and corner version for left or right (all 180x80 cm). The combination with the optional Air-System ensures perfect relaxation.



Magic material. To date there hasn't been a material capable of creating delicate shapes that also need to be highly stable. However, Duravit has developed one.

DuraCeram®

What's so innovative about DuraCeram®?

DuraCeram® is based on an innovative formula that enables us to create more precise and delicate forms than are possible with conventional ceramics. It also permits uniquely thin, absolutely smooth edges that would be unthinkable with standard sanitary ceramic materials, which distort in the kiln and shrink by up to 11 percent. DuraCeram®, on the other hand, is noticeably more dimensionally stable. This opens up brand-new design opportunities. DuraCeram®: ceramics at the top of its game.

How did this Duravit innovation come about?

On the one hand, we are of course constantly on the look-out for improvements and innovations. On the other, our designers make demands on us. While working with Philippe Starck on his new bathroom range Cape Cod, we were looking for especially delicate and precisely worked forms for the new wash bowl models. Additionally, Cecilie Manz asked for an innovative, delicately coloured glaze. And when developing DuraSquare, our own requirements demanded absolute dimensional tolerance and a precisely contoured shape. We wanted to reduce the wall thickness of our ceramics without compromising on strength, quality, robustness and ease of care. It was like squaring the circle. However, with DuraCeram® we indeed created a work of art.

And what is the secret behind the DuraCeram® formula?

Sanitary ceramics are usually made from clay, kaolin, quartz and feldspar. To achieve the necessary strength, it is usually around 12 mm thick. This thickness does not allow delicate geometries to be realized. However, if you change the mixture, add innovative raw ingredients and change the grinding fineness of raw material and compound, the qualities change noticeably: the colour of the fired ceramic is lighter, with even more glaze coverage.

That doesn't sound too complicated, does it?

Well, it is. DuraCeram® is the result of a complex development process, the outcome of which we have patented. However, DuraCeram® is a lot more difficult to prepare. The different raw ingredients, the finer grinding degree and the more complex production process make the material more expensive than standard sanitary ceramics.

Is that the end of conventional sanitary ceramics, then?

Absolutely not. Sanitary ceramic remains the material of choice for lasting design in the bathroom. DuraCeram® is a modern update that opens up new possibilities in design for us.



Delicate shapes, precise and eye-catching: DuraCeram® is a statement, whether it's square or round.

**“DuraCeram®
ceramics at the
top of its game”**

Thomas Stammel is the Chief Technology Officer at Duravit, responsible for technologies and materials – such as the innovative DuraCeram®.

New materials, new opportunities, reduced to the bare essentials.

Ms. Müller, looking at Duravit's latest products is like immersing yourself in a drawing, so fine are the contours of the basins and bathtubs. Where does this lightness come from?

The general trend in bathrooms is toward more delicate forms. But we can already see much of this in earlier series from Duravit.

For example?

Take Vero. When this series was launched in 2001 – initially just as a family of washbasins – it was something of a revolution: the rectangular basic shape, the straight inner surface – that was new at the time. Washbasins were round and easy to produce. Firing square shapes is a much bigger challenge. However, our developers really wanted to try it – especially because it was a brand-new idea. Initially, the design produced in-house totally polarized people. Nowadays, Vero has long been an architects' favorite, because it fits into a Bauhaus cube just as well as into a renovation project. The series has become a true classic.

Square or Whatever



So why have you reworked it now?

Because today's state of technology is different from 17 years ago and gives us the opportunity to emphasize the character of Vero even further. We have reduced the edge thickness, made the outer and inner radii a little sharper and brought the outlet valve further forward, so when you look into the basin you see a harmonious overall picture and nothing detracts from the precise lines.

"Vero Air", the name of this new series, is made from standard sanitary porcelain. Wasn't it possible to produce even thinner walls and sharper edges with the new, extra strong and dimensionally stable material DuraCeram® developed by Duravit?

We could actually have achieved greater reduction with normal sanitary porcelain – but that wouldn't have been Vero any more. The series was to have a more delicate look but also retain the slight curvature of the contour. In fact, this impression was reinforced with the toilet. Originally it was very angular, and now the lower part has a deliberately softer design so that it also suits the other Duravit series.

round? you like!

After stints at Welt am Sonntag, Vanity Fair and on the editorial board of A&W Architektur & Wohnen, Gabriele Thiels (left), culture and lifestyle journalist with a special interest in design, is now Head of Design at Icon, the Welt am Sonntag supplement.

Joanna Müller (right) is responsible for product management for ceramics at Duravit and as such mediates between the designers and the production department.



So the goal isn't to produce extra thin and extra angular shapes at any cost?

We're interested in a new freedom of design that enables us to stay true to ourselves. You can see that in the DuraSquare series in particular, which is made from DuraCeram® and is essentially an upgrade of Vero Air. The rectangular washbasin has a soft, fluid inner form. As such it forms a subtle interface between the room and the user: its cubic exterior is part of the architecture; while its organic interior references the body. The design is perfectly in line with the product philosophy that Duravit and its in-house design team has pursued for years in liaison with notable designers: to be contemporary without being trendy.

Do you see this as part of a general trend for the bathroom – in future, will materials be more important than digitalization?

I think we'll see both. Those deliberately creating their own smart home will without a doubt want to turn the mirror light on and off using sensors or fill the bathtub via an app. And equally there will always be people who literally want to switch off, to wash or shower without concentrating on the technology.

New precision, perfect proportions. Architectural.
Straight-lined.

Vero Air

Design Duravit

Bathroom ceramics in White, DuraCeram® for c-bonded

Bathroom furniture Vero Air, L-Cube, alternatively metal console in Chrome

Bathtubs Bathtubs in 4 sizes, from 170x70 cm to 190x90 cm, freestanding, back-to-wall, corner and built-in versions, with or without whirlsystem

Shower-toilet SensoWash® Slim

Interesting details Narrow edges, exact geometric consistency

Guiding principle Pure geometry creates pure elegance

New developments in the rectangle:

In 2001 Duravit's Vero range laid the foundation stone for architectural bathroom design. Architecturally clear, pared down to the bare essentials, Duravit has consistently developed the defining design language of the classic Vero series and in doing so has created the Vero Air complete bathroom range. No compromises, either on the washbasin or the bathtub and toilet.

State-of-the-art technologies in the manufacturing processes permit this extremely precise design. Reduced edges, exact radii and the straight-lined inner surfaces form the striking features of the series. A strict aesthetic, the airily light lines and the precise angles turn the minimalist geometry into a style-defining element in the bathroom.



The Vero Air washbasins boast streamlined surfaces, small and exact radii, optimized proportions and narrower edges. Whether in a width of 50 or 60 cm: in combination with the C.1 tap fittings which are perfectly harmonized with Vero Air, form and proportions come together to create a harmonious whole.

Vero Air with c-bonded technology

The innovative technology enables washbasin and vanity units to be combined to produce a masterpiece in minimalism. Precise and finished to the millimetre, the furniture begins exactly where the ceramic ends. The materials blend together seamlessly to form a single, harmonious unit. This is doubly impressive on Vero Air because the geometrically precise interior is picked up by the clear exterior edges. The ceramic slotted waste ensures that nothing disrupts the homogeneous aesthetic.



At first glance: a complete bathroom with an unmistakable character. At second glance you notice its perfect proportions and the exact radii. The elements combine optimally with Vero bathroom furniture, which has been specifically attuned to Vero Air.

The stylish furniture frame showcases the perfect proportions of the Vero Air ceramics. The sleek, chrome-coloured feet are height-adjustable. Bars serve as towel holders. A simple aesthetic, yet nonetheless a statement for any bathroom.



Above-counter basins

The above-counter basins boast streamlined surfaces, exact radii and optimized proportions. They are available in two sizes, 50 and 60 cm, with or without tap platform.



Something of a formal and functional sensation. The rectangular basic form of the toilet finishes with a gentle curve downwards. Specially optimized for the rectangular geometry of the toilets, the Duravit Rimless® technology produces impressive flushing results. Optionally available with the anti-bacterial ceramic glaze HygieneGlaze 2.0 and the SensoWash® Slim shower-toilet seat.



Vanity units

The Vero Air vanity units have been specially matched to the ceramics. The minimized overhang in conjunction with the furniture emphasizes the straight-lined design. A range of individual solutions is possible, from the individual to the double washbasin.



Precise transition and combination of ceramic and furniture. The ceramics can be combined with Vero Air vanity units, Vero and L-Cube furniture. 35 attractive furniture finishes: décor, real wood, high gloss/lacquer, matt lacquer enable a wide range of combination possibilities.

The Vero Air vanity units and Vero tall cabinets provide plenty of practical storage. The height-adjustable chrome feet provide additional stability.



The furniture washbasin translates the consistently rectangular formal language of the series into the smallest of spaces, shown here in combination with the L-Cube vanity unit. The Oak Cashmere furniture finish in real wood veneer emphasizes the clear geometry.



Distinctive lines, exact angles, geometric consistency: the Vero Air washbasin expresses itself in its most perfect form, with reduced edges and a striking linear charm. In particular, the straight interior surfaces and precise radii of the washbasins define the characteristic look of the series. The ingenious geometry for the base of the bowl enables perfect drainage.





The son of a master carpenter and a fashion designer spent some time working in the studio of Antonio Citterio before he opened his own design studio in Zurich in 2010. Today he designs stores, clubs, hotel lobbies and furniture.

Kurt Merki Jr.

Optimizer and problem-solver

It's a brilliant première: the first tap fitting series from Duravit, designed by Kurt Merki Jr. As iconic design elements they perfectly match the washbasin and bathtub.

Who is Kurt Merki Jr. as a person and a designer?

I don't see myself as a designer. I see myself more as a person that creates new things and transforms dreams into reality. As a person, I am also an optimizer and a problem-solver, who always strives to think outside the box. I don't start off thinking about the end product, but rather about the entire creation process as a whole, and try to determine the materials and technologies that will allow me to achieve the best-possible result. What helps me to do so is my binational background.

You grew up in two cultures – to what extent has that left its mark on you?

For me, life in two worlds – in Ghana and in Switzerland – was very enriching. It made me aware of how extremely different the problems, rules and needs of the various cultures are. This knowledge also flows into my work.

Is there a particular leitmotif that inspires you as a designer, or as an optimizer?

My goal is always to make other people's lives better and easier. And we're not only talking about the finished product. For me part of this is also the question of how I can simplify the manufacturing process or how materials can change over the course of the years. Initially I work like a little boy running around with his arms in the air, shouting: "I can fly." While my feet may remain firmly on the ground, my thoughts roam free. It is in this phase, where one moves between reality and euphoria that the most creative ideas arise, but if inspiration is to lead to concrete results, it is necessary to drive it forward. Otherwise, one is left with nothing more than a dream.

"In order to create something that is truly good, one needs a great deal of dedication, diligence and time."

How did you approach the challenge of designing the first tap fitting range for Duravit?

First I familiarized myself with the technical background to identify the design limits. I always start by looking at the big picture; in this case the scope of the required tap fitting range with the corresponding individual products, then zoom in on the details. Then I keep on sketching until I am absolutely satisfied with my design.

How do you come up with an iconic idea like the C.1 tap fitting range?

The design process starts with a thought or an idea. Then I start to sketch. That can be quite chaotic, as you can imagine – on different bits of paper, on the front and back, on notepads. At some point I know: "That's it!" I am convinced that when I sketch I'm simply giving expression to something that already existed in my thoughts.

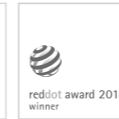

Perfect form, perfect functionality. The C.1 tap-fitting range continues Duravit's high design standards in the area of bathroom tap fittings. Designed by Kurt Merki Jr.

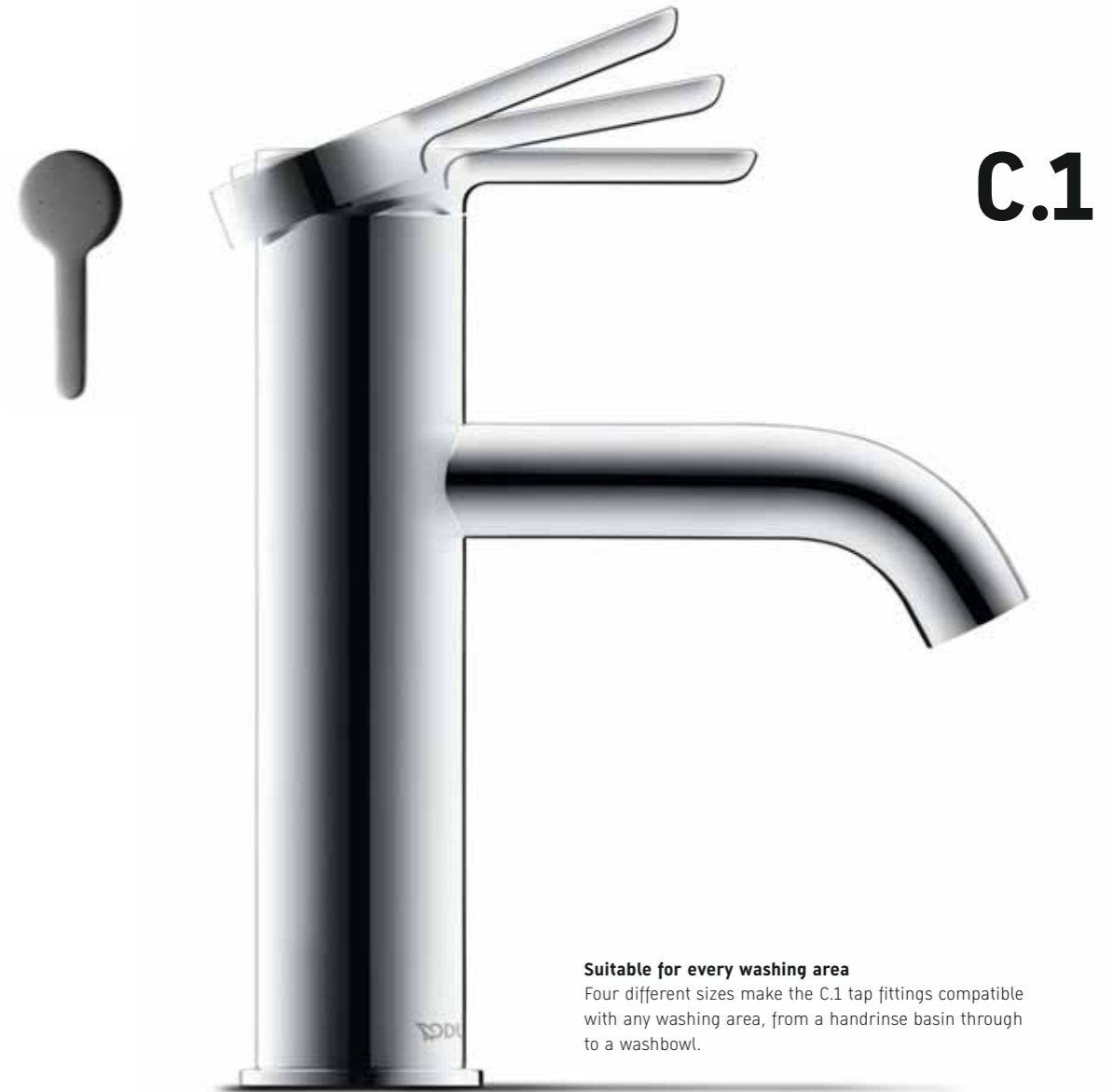

C.1

Single lever basin mixer

Suitable for every washing area

Four different sizes make the C.1 tap fittings compatible with any washing area, from a handrinse basin through to a washbowl.



S # C11010 0020 10



M # C11020 0020 10



L # C11030 0020 10



XL # C11040 0020 10



Single lever basin mixer XL
C11040 0020 10

Perfect partners

The XL variant is perfect for combination with taller above-counter basins. All pillar taps can be supplied with or without pop-up waste control.



Single lever basin mixer M
C11020 0010 10



Single lever basin mixer for concealed installation
17,4 cm # C11070 0030 10
22,5 cm # C11070 0040 10



3-hole basin mixer
14 cm # C11060 0030 10
16 cm # C11060 0040 10

3-hole basin mixer with pop-up waste set
14 cm # C11060 0050 10
16 cm # C11060 0060 10



Washing area alternatives

As well as the single-lever mixer variants, C.1 is also available as a classic three-hole tap fitting as well as a wall-mounted fitting, each with two spout lengths.



Shower System with thermostatic shower mixer for exposed installation
Showerhead 24 cm, hand shower 12 cm
C14280 0080 10

Shower System single lever shower mixer
C14280 0070 10



Single lever shower mixer
C14230 0000 10



Showerhead ø 30 cm
UV0660 0150 00
Single lever shower mixer for concealed installation with diverter valve, hand shower
C14210 0120 10 - # UV0640 0000 00



Individuality guaranteed

Virtually any conceivable exposed or concealed solutions can be realized for the bathtub.

Single lever bath mixer for exposed installation
C15230 0000 10



Bath spout (round escutcheon)
C15240 0100 10



Bath spout (square escutcheon)
C15240 0090 10



Single lever bath mixer for concealed installation with diverter valve (round)
C15210 0120 10



Thermostatic bath mixer for concealed installation with shut-off valve and diverter valve (square) with scalding protection at 38°
C15200 0130 10



Single lever bidet mixer
B12400 0010 10

Design freedom

In the shower area, the B.1 range offers products for practical showerhead solutions.



Single lever bath mixer for concealed installation with diverter valve
B15210 0120 10

Single lever bath mixer for exposed installation
B15230 0000 10



Thermostatic shower mixer for exposed installation
B14220 0000 10

Single lever shower mixer for exposed installation
B14230 0000 10



For every bathtub situation

The B.1 single lever bathtub tap fittings are available in exposed and concealed variants, the latter with a separate bath inlet.



Familiar soft forms for private and project bathrooms. Soft contours, appealing and timelessly elegant. A universal range of tap fittings for all standard applications: washing area, shower, bathtub and bidet.

B.1



Single lever basin mixer

No splashing

All Duravit basin mixers are fitted with an adjustable aerator to reduce spray from the water jet.



S # B11010 0020 10



M # B11020 0020 10



Single lever shower mixer
for exposed installation
B24230 0000 10



Single lever bath mixer for exposed installation
B25230 0000 10



Single lever bath mixer for concealed
installation with diverter valve
B15210 0120 10



Thermostatic shower mixer
for exposed installation
B24220 0000 10

A safe way to enjoy water
All Duravit thermostats have integrated
scald protection that protects against
excessively high water temperatures.

Clear, straight-lined tap fittings for all applications. Bathroom users who appreciate clarity, pared-down design and a sober aesthetic will find a perfect form of expression in the B.2 tap fitting range - for private bathrooms and the project sector.

B.2



Single lever basin mixer

Matches all ceramics
The basin mixer comes in two sizes. Thanks to the
adjustable aerator, the water jet can be adapted to
any basin with optimized spray reduction.



S # B21010 0020 10



M # B21020 0020 10

The new shower-bath combination: a major space advantage, even in small bathrooms, with more creative leeway when it comes to bathroom planning.

Shower + Bath

Design E00S

Bathtub made of DuraSolid®, available as a corner version for left or right, shower enclosure in clear glass or mirrored

Interesting details Cushion doubles as backrest; compact dimensions

Guiding principle Unites modern bathroom design and optimum use of space, ideal for renovations

Walk-in shower and bathtub in one. Bathtub, bathtub paneling and pedestal made from DuraSolid®: the innovative material enables sophisticated designs to be realized – narrowly defined radii, high-quality, generously sized shower area, comfortable large bathtub. The bathtub, which measures 170 x 75 cm, is available as a corner-left or corner-right variant.

The shower enclosure is in clear glass, also optionally mirrored. A practical whole-body mirror, it can also make small rooms appear larger. The almost vertical sloping sides on the inside create more space and greater room to move when showering. Given its compact dimensions, the bathtub is also an ideal solution for renovations.



Waterproof cushion while showering. Comfortable backrest that can be individually positioned while bathing.

Bathtub paneling and pedestal made from DuraSolid®

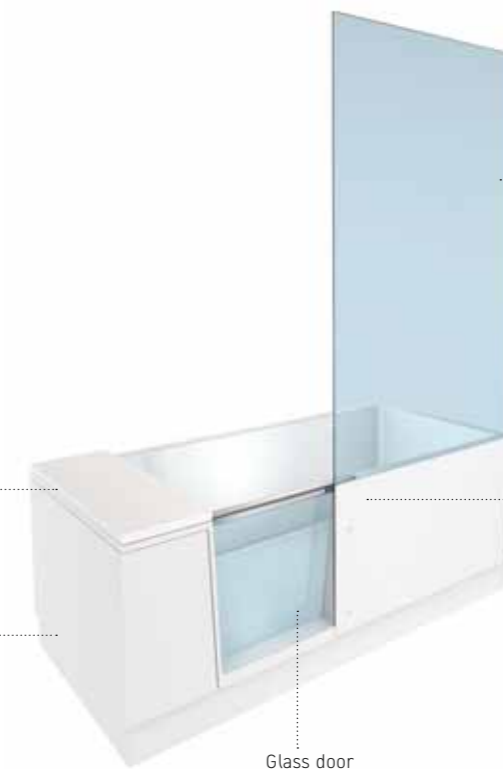

Glass door

Shower enclosure in clear glass, optionally mirrored.



Special outlet/drain



The outlet/drain is also available with an integrated bath spout so that filling the bathtub is easy. The mechanical safety lock ensures that the glass door cannot be opened when the drain is closed. This does not require an electrical connection.



Martin Bergmann, Gernot Bohmann and Harald Gründl work as E00S for brands like Dedon, Walter Knoll, Alessi and Bulthaup. They have designed many products for Duravit that are emotional and intelligent at the same time.

E00S

The new airiness of bathing

The Viennese designer trio E00S is not only one of the most sought-after design agencies of our age, but also the creator of many successful Duravit products.

Mr. Bergmann, with Shower + Bath your trio has invented an immensely practical combination of shower and bathtub. The idea is so good that you have to wonder why no one came up with it before?

A good question. Of course, a great many designers have worked on this topic, not to mention manufacturers who offer bathtubs with doors. That's not new. The fact is that you're always faced with a bathtub with a door cut into it. We wanted to go beyond that. Our idea was developed from the transformation of the two functions on offer.

And how did you develop the idea into Shower + Bath?

Years ago we started looking at the issue of space efficiency in growing cities with very small floor plans and bathrooms. Shower + Bath is an extremely efficient and magical product combination.

Shower rooms – i.e. bathtubs with shower fitting and lateral spray protection – have been around for ages.

The thing is, with these shower rooms you have to climb over the edge of the bath to shower. Conversely, Shower+Bath lets you step inside as you would with any normal walk-in shower with a seat and a whole-body mirror. In this option the bathtub door disappears completely under an archaic seat. If on the other hand you want to take a bath, you close the door and turn Shower+Bath into a bathtub. So with Shower+Bath you don't actually have a multi-function product, you simultaneously have a high-quality shower and also own a bathtub. And both exactly when you want them.

Which do you prefer yourself: taking a shower or taking a bath?

I love showering more than anything else. But my family often also wants the functionality of a bathtub, so Shower+Bath would be the right product. I'm also putting it in my own bathroom in Vienna.

Your design portfolio ranges from seating through kitchens to bathroom products. How do you manage to transfer your design quality from one product group to the next with this continuity?

We cultivate strong relationships with our customers and always work with them in a flow. This flow is the guarantee that the end of one project is the start of the next and every idea leads to another idea. This also produces the continuity from one product group to the next.

"Bath or shower?
We like both."

E00S





Archaic forms, innovative ceramics and solid real wood. Philippe Starck took these elements and transformed them into a bathroom series that refreshes body and soul.

Cape Cod

Design Philippe Starck
Bathroom ceramics in White and made of DuraCeram®, exterior of the ceramic bowls in White Matt (optional), interior in White
Bathroom furniture in solid real wood or White high-gloss lacquer finishes
Bathtubs Bathtubs made of DuraSolid®, as a freestanding model, back-to-wall or corner version, optional with Air-System
Interesting details Perfect materials, unusual proportions, elegant finish
Guiding principle A bathroom range like a day at the beach

Cape Cod, which is located in New England on the east coast of USA, possesses a memorable flair. It is a region of sandy beaches that stretch for miles, crystal-clear water and untamed nature – and it was the inspiration for the range. Cape Cod eliminates the barriers between the indoors and outdoors, making nature a permanent part of the bathroom with organic forms and authentic materials such as solid real wood and ceramics in White or with a matt-coloured exterior. As with the washbowl and bathroom furniture, the Cape Cod bathtub also fuses material and form to create a new,

innovative unit. Made from the new Duravit material DuraSolid®, the design by Philippe Starck can be realized to a high level of detail: delicate bathtub rims, organic shapes, gentle curves. Monolithic right up to the backrest, the integrated headrest that can also be used as a shelf, this bathtub boasts a consistently satin-matt, surface that is pleasant to the touch. The architectural simplicity of the design is retained not only in the freestanding version, but also in the back-to-wall and corner versions for left or right.



Consoles and shelves are supported by high-gloss chrome frames with integrated wall-mounting.

Each item is unique: produced from solid wood, each of the consoles and shelves from the Cape Cod bathroom furniture range boasts a unique grain, and the solid vintage oak version has an irregular console edge.



The Cape Cod washbowl is like nothing you've seen before: high-quality, attractive porcelain, fine, extremely thin edges just 5 mm thick. This is made possible by the innovative material DuraCeram®: this results in outstanding elegance, without compromising on quality, robustness or ease of care. In order to allow scope for individual bathroom design, the bowl is available in three different formats: square, round and tri-oval. In the round and square versions, the tap fitting is located on a tap platform integrated in the basin.

The characteristic feature of the Cape Cod bathroom furniture is the perfect, unseen fusion of material and form. Manufactured from solid wood cut directly from the trunk, each item of furniture is unique. There are four different types of wood available. The solid Vintage Oak version with its irregular

edges is reminiscent of a ship's plank, aged in a storm washed up on the Atlantic coast that carries the aroma of the ocean and salt into the bathroom. The White High Gloss version offers an elegant alternative, and is also available with an integrated vanity unit.

Depending on the selection made, the toilets and bidets of Duravit's Starck 1, Starck 2 and ME by Starck ranges offer a harmonious addition – to create a complete bathroom that satisfies the most demanding aesthetic standards.



77 American Walnut solid



81 White Beech solid



85 White High Gloss



76 European Oak solid



95 Vintage Oak solid



85 White High Gloss with doors

Mirrors perfectly harmonized with the range: the elegantly refined all-round LED light generates a pleasant lighting atmosphere in the bathroom.

The unusual form and material mix featuring chrome and White High Gloss finish produce an extremely elegant ensemble. Additional open storage shelves are located next to the storage area with closing doors.







Reduction paves the way for greater individuality.

ME by Starck

Design Philippe Starck

Bathroom ceramics in White

Bathroom furniture L-Cube, Ketho

Bathtubs The Starck and Cape Cod bathtubs and Starck Slimline shower trays all match perfectly

Shower-toilet SensoWash® Slim

Interesting details Extraordinarily delicate design, narrow edge, large, deep inner basin, spacious storage shelves

Guiding principle The most individual bathroom ever

Relaxed contrasts: The more digital and perfect the world wants to be, the greater will be the desire for the genuine. Design, elegance, sustainability, nature, luxury – perfect contrasts with the unadorned modernity of ME by Starck. With a bathroom series offering pure aesthetics that slips harmoniously into completely different styles, thereby

opening up maximum individual design freedom. Pure understatement, reduction, functionality and a clear aesthetic: a timeless design claim by Philippe Starck responds to a saturated world. The desire for tidiness is reflected in a simple lifestyle that can be perfectly showcased with ME by Starck.



The ME by Starck furniture washbasin, width 103 cm, combined with the L-Cube bathroom furniture programme. Here in the finish Flannel Grey High Gloss (89).

Real elegance does not follow a particular time or movement, but rather seeks out the highest standards. It's the combination of select materials and subtle luxury. Extravagant, but not extroverted. Just like ME by Starck, which slots into a contemporary, elegant ambience.

From right to left: Furniture washbasin 83cm with L-Cube vanity unit in Dolomiti Grey, wall-mounted bidet and toilet, shower-toilet seat SensoWash® Slim. A perfect match: freestanding Cape Cod bathtub and mirror with LED lighting, also by Philippe Starck.

Overall 35 furniture finishes > L-Cube from p. 104



ME by Starck How can you design a contemporary yet timeless bathroom range that slots into the various furnishing and living worlds? When developing the ME by Starck range, the designer Philippe Starck and Duravit faced these precise challenges: perfectly designed forms that do not dominate the space, leaving plenty of scope for customization and design. Products that look well-proportioned from any perspective and at the same time are capable of realizing individual ideas. ME by Starck is the result, the frame on which to hang your highly personal style: whether that's minimalist, elegant, natural or completely unorthodox.

With ME by Starck you are your own designer. Different sizes of washbasins, handrinse basins, above-counter and built-in basins, furniture washbasins, bathtubs, shower trays, toilets with rimless flushing technology, SensoWash® Slim shower-toilet seats, bidets and urinals. With matching furniture from the L-Cube programme, wall-mounted or with chrome feet.



Washbowl



Semi-recessed basin



Double furniture washbasin



Normal



Compact



Handrinse basin



Handrinse basin corner model



Furniture handrinse basin



Furniture washbasin

The washbasin with siphon cover or pedestal has the same reserved and characteristic design language as the whole series: the generously-proportioned inner basin is surrounded by a delicately shaped edge.



Toilet wall-mounted with Duravit Rimless®



Toilet wall-mounted with SensoWash® Slim



Bidet wall-mounted



Toilet floor standing close-coupled



Toilet floor standing close-coupled



Urinal Duravit Rimless®



Urinal Dry

**"Modern design
avoids design."**

Philippe Starck

ME by Starck furniture washbasin with L-Cube vanity unit. Exterior: White High Gloss, two drawers, handle-free fronts with tip-on technology and self-closing action. Interior: Diamond Black, organizer system in Walnut or Maple, creates ample storage and order, enabling surfaces in the bathroom to remain free and visually tidy. Other variants: Vanity unit with just one pull-out compartment, floor-standing with chrome-coloured feet. An ideal match: Starck built-in bathtub and L-Cube mirror with LED lighting.



Restaurants, hotels, clothing, bathrooms, TV and HiFi units, kitchen appliances: Philippe Starck makes it simple – it's fantastic. At the same time he is untiring in his commitment to referencing the roots and origins of our existence in design and by doing so enabling a better quality of life. Another feature of Starck is his sense of humor. For example, he christened his telephone "Alo", and Starck's little light is named "Miss Sissy".

Philippe Starck

The "enfant terrible" of the design world

When Philippe Starck and Duravit realized their first joint project in 1994, it was love at first sight. However, neither side could have imagined how successful this liaison would be. The breakthrough came with the famous "Starck barrel", which to this day is one of the classics among the Duravit range.

It's a designer's most important tool, but what does creativity actually mean to you?

For me creativity is the meaning of life, but it's also like a mental disorder at the same time. I live alone like a monk: I get up early, go to bed early and eat as little as possible. Except you don't see that because I also travel a lot and am frequently moving into the future. How I got here can be easily explained using the Faust myth. As we know, Faust sells his soul to the devil. As a young man I must have made a similar mistake. I sold my soul to the devil so I could be creative. And for that reason it's all I'll do from the day I was born until the day I die.

You work with a lot of different materials from plastic, wood through to metal. What's working with ceramics like?

Porcelain is the most difficult material in the world. But Duravit is an expert in a very complex field: shaping porcelain. I see the finished shape and say, "That's not the shape I drew." And they reply, "Yes, it is. We do that because the porcelain has these or those qualities. We'll figure it out." It's fascinating. What matters here is not theories or computer simulations. What matters is experience. Collecting insights from experience is one of the most valuable qualities of the human species. It's great when humans discover something by chance through

observation and then use this invention in a meaningful way, constantly improving on it.

How has the bathroom changed since the start of your partnership with Duravit?

Right at the start, the wonderful people from Duravit approached me with the request to design some objects based on certain prescribed colours and shapes that looked more like fashion articles. I turned them down. But that was a misunderstanding because I couldn't imagine that a washbasin could be fashionable. After all, we're talking about a sturdy object that is supposed to fulfil its function for as long as possible. And so we turned away from the consumer product and dedicated ourselves to the utility item, which was very important. After all, you use these products for many years, which is why they need to be free from all trendy aspects. Over time we developed a common notion of what we mean by durability. And the people at Duravit have internalized that.

And what's it like today?

What I especially like about Duravit is their absolute honesty. That's all about offering the customer as honest a product as possible. And that takes hard work, love of one's work and a certain tenacity. Although we're a well-coordinated team, not a single product is marketed that hasn't been carefully thought through for three or four years. At the start that was a completely new approach for me. You see, I have a much quicker working rhythm, though at the same time durability and tradition are of course really important for me. In an age of ubiquitous and rapid consumption, it's nice that people say, "No!" No, we're not going to make any old thing, we won't put ourselves under pressure for the sake of market share, we won't do anything hurriedly, we won't work with technologies that we haven't mastered. We'll either do it right or not at all. That's Duravit.

What can good design do or impact today – and the same for a designer?

You always need to remember that design is not essential for life. Things would be different in a professional field that is essential for life, that saves lives, that creates lives. At best, design can hope or claim to make life better. But that's not so crucial nowadays because so many people are living in hardship and we need to be thinking about saving lives. Soon there won't be any product designers left anyhow because the concept of dematerialization is increasingly taking root. The material flows within the economy are constantly decreasing. The fewer materials there are in circulation, the more strongly skills and power are pooled. The only exciting question is how that should look in future. The past is behind us. We need to deal with the present. And the future is the realm of dreams, beauty and creative endeavor.

"I've always said that the bathroom has to become a wet living room. But no one understood me. Apart from Duravit. That's why I love Duravit!"



Video on www.duravit.com/PhilippeStarck



▶ 0:00 / 9:04

Philippe Starck

Philippe Starck was born on 18th January 1949 in Paris, the son of aircraft designer André Starck and his wife Jacqueline. He spent his childhood under his father's drawing board, where he would spend hours sawing, cutting, gluing and sanding. From his father he inherited his inventive nature, and from his mother his poetic view of the world and his elegant life style. It was she who advised him to study design at the École Nissim de Camondo in Paris. Starck took his first steps as a designer using inflatable objects before he became known for furnishing the private quarters in the Élysée Palace of French President François Mitterand in 1983. Shortly afterwards, his interior design of the Café Costes in Paris made him an international star. Today he creates "intelligent" objects with a commitment to humanity: Smartphones, televisions, luggage, kettles, knives, vases, watches, scooters, motorbikes, prams, computer mice, even ships and houses - all in all objects for all aspects of life. A particular passion of his is the bathroom or the "salon d'eau", which he and Duravit have been designing together for 25 years.



Classically beautiful

Washbasin as a bowl, with a matching barrel-shaped vanity unit, interior in Matt Black with a glass shelf.

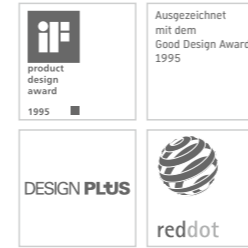

Back to the beginnings of bathing culture: in 1994, inspired by the bucket, the tub and the washbowl, Philippe Starck created a complete bathroom featuring pioneering craftsmanship that appears as fresh and new today as it was then.

Starck 1

Design Philippe Starck
Bathroom ceramics in White
Bathroom furniture with 3 real wood veneers and 2 lacquer finishes
Bathtubs Starck bathtubs in 16 different sizes from 160x70 cm to 200x100 cm, with or without whirlsystem, Starck Slimline shower trays in 29 different sizes, from 80x80 cm to 120x100 cm
Interesting details The barrel washbasin, the toilet, the bathtub
Guiding principle From the origins of bathing culture to iconic status and an absolute classic for the bathroom

Modern archetypes: Whether washbasin, toilet, bidet, urinal or bathtub. In designing his first bathroom series, Philippe Starck harked back to the origins of a bathing culture that started with the washbowl, bucket and tub. His feel for form and function secured the French designer an honorary place

in the history of bathroom design. The famous Starck barrel is also inspired by the archaic form of the bucket and the bowl. With a simple handle Starck sets an interesting contrast to the almost seamlessly mounted doors that open outward like wings.



Clear lines and timelessly beautiful: wall-mounted toilet with overlapping lid, with wall-mounted bidet.

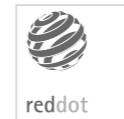

Modelled on nature, based on the principle of reduction. In a bathroom series in which the designer was clearly inspired by the movement of water.

Starck 2

Design Philippe Starck
Bathroom ceramics in White
Bathroom furniture with 5 finishes, including Black and White High Gloss, and 2 real wood veneers
Bathtubs Starck bathtubs in 16 different sizes from 160x70 cm to 200x100 cm, with or without whirlsystem, Starck Slimline shower trays in 29 different sizes, from 80x80 cm to 120x100 cm
Shower-toilet SensoWash® Starck C and SensoWash® Slim
Interesting details Extra-shallow shower tray, bathtub with exposed neck rest, washbasins also in small sizes, toilet with SensoWash® possible
Guiding principle Everything flows, everything fits together

Fluid forms. At first glance, the washbowls by Philippe Starck appear circular but, on closer inspection, are actually slightly oval. The ceramics seem to flow gently rather than have austere geometric lines. The unadorned design of this range takes its place amongst the design classics.



In the washing area with a comfortably deep washbasin, the conical widening of the edges of the basin towards the wall creates shelf areas and this design feature is to be found in the above-counter basin, as well as in the washbasins with pedestal and semi-pedestal. In addition to the small handrinse basin with dimensions 50x39 cm, the programme also includes washbasins in three different sizes.

Just as comfortable: fitting the Starck 2 toilets with SensoWash® Starck C or SensoWash® Slim.



What defines a timeless, good design?
Concentrating on the essentials.

Starck 3

Design Philippe Starck
Bathroom ceramics in White, with more than 50 models or 64 variants
Bathroom furniture from DuraStyle, Ketho, X-Large and L-Cube
Bathtubs Starck bathtubs in 16 different sizes from 160x70 cm to 200x100 cm, with or without whirlsystem, Starck Slimline shower trays in 29 different sizes, from 80x80 cm to 120x100 cm
Shower-toilet SensoWash® Starck C and SensoWash® Slim
Interesting details Barrier-free versions (Vital) for washing areas and toilets
Guiding principle One design, many options

How does one create something completely original? By being the first to think about it. Being the first to design a shape. Being the first to implement a strategy. Duravit and Philippe Starck achieved all that with the Starck 3 bathroom range.

Starck 3 introduced design to a segment where there was no design. And at surprisingly good value for money – after all, we are talking about an original Philippe Starck.

With a diverse range of products that simply meets all requirements. With more than 50 models and 64 variants, Starck 3 is probably the most extensive bathroom range ever.

The original, that's been frequently copied, but never matched. Starck 3 remains the measure of all things when it comes to design, variety and price.



The toilet is available in 18 different wall-mounted and floor-standing versions, optionally with the SensoWash® Starck C or SensoWash® Slim shower-toilet seat. Like all Duravit toilets, it flushes with either three or six litres of water (dual-flush function) and has a glazed, easy-clean flushing rim.





Depending on the choice of vanity unit, the washing area can form a strict monochrome (left with L-Cube) or attractively contrasting unit (right with Ketho in Graphite Matt with double washbasin).



Eschewing the superfluous
A simple rectangle, a surrounding rim, an upturned lip to the wall connection. Everything well-thought through.

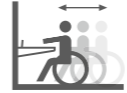

Open beauty
Starck 3 can be used to furnish private, public or semi-public and, if necessary, also barrier-free rooms.



Balanced proportions and convenient storage also on the floor-standing vanity units: whether in combination with the ceramic series P3 Comforts (left) in Dark Brushed Oak or c-bonded in combination with Darling New in White High Gloss (right).



No handles, no unnecessary elements, no distractions. The resulting range of unadorned bathroom furniture creates maximum elegance with minimum means.

L-Cube

Design Christian Werner

Bathroom ceramics can be combined with furniture washbasins of the ranges Darling New, ME by Starck, Starck 3, P3 Comforts, Vero Air and all above-counter basins

Bathroom furniture in 35 different furniture finishes: 16 different wood décors, 8 real wood veneers and 13 lacquer finishes (matt or high-gloss)

Interesting details shadow gaps that visibly separate the surfaces; shelf elements that can be hung both horizontally and vertically

Guiding principle Contemporary and contemplative, bathroom furniture as a collage

Tranquility. Clarity. Space for contemplation. This is how designer Christian Werner describes his vision that gave rise to the L-Cube. The interplay of horizontal and vertical lines creates a functional and structured look. The subdivision of the furniture fronts into rectangles and squares highlights the cubic appearance of the furniture compositions.

A key characteristic of the range is a shadow gap that surrounds the fronts and sides of the furniture. This visual framing places the washbasin on a higher level – making it appear as if the ceramics, furniture and furniture fronts do not touch one another. The style, function, 'feel' and colour scheme can be selected individually, allowing you to create customized storage solutions.



Generous

The consoles can be up to two metres long with a vanity unit running along their entire length. With one or two drawers below, they form a stable and elegant unit. The shadow gap between the countertop and the vanity unit creates a sense of lightness. Within the tall cabinet and semi-high cabinet, glass shelves with anodized aluminum brackets in Diamond Black keep things tidy.

No handles? Instead, the new tip-on technology. The drawers of the units open when tapped. A gentle nudge and they close automatically. Inside, a Duravit organizer system available in either Maple or solid Walnut keeps bathroom articles in their place.

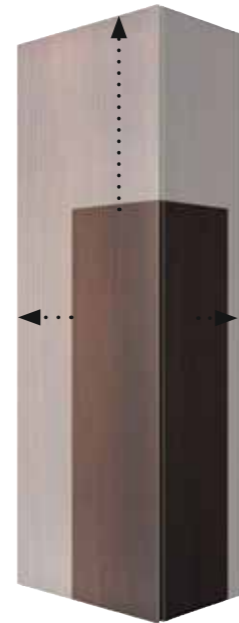

You decide the dimensions for height (60 – 200 cm), width (25 – 50 cm) and depth (20 – 36.3 cm) depending on your individual needs. All 34 colours are available.



It not only shows you at your best, but looks fantastic itself: the L-Cube mirror. It comes in ten width variants, while the L-Cube mirror cabinet – which can also be set into the wall – comes in four different widths. What they both have in common is their striking design that is a perfect supplement to many Duravit ceramic ranges!

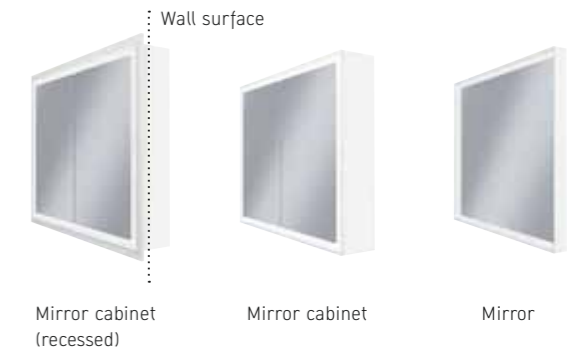

The console is part of the universal console programme and is available in different widths from 60 to 200 cm. A calm, harmonious image is produced in combination with the vanity units and the mirrors.



The L-Cube bathroom furniture programme is perfectly matched to Duravit's Darling New, P3 Comforts, ME by Starck, Starck 3 and Vero Air ceramic ranges. The furniture washbasins form a harmonious unit with the L-Cube vanity units.



The L-Cube console applications can be combined with any Duravit ceramic ranges – even in the smallest of spaces.



If a secure wall-mounting is not possible, chrome-coloured feet ensure that the furniture will remain stable, with various alignment options.



c-bonded: harmonious to the eye, an experience to the touch. The innovative connection of ceramics and L-Cube furniture.



Christian Werner, born in Berlin, is one of Germany's best interior designers and has won multiple design awards. Werner specializes chiefly in furniture design (Ligne Roset, Rolf Benz, Thonet, de Sede, Interlübke), trade-fair booths and interior design for stores, agencies and restaurants. Christian Werner was the first furniture designer to work with Duravit and started with the Ketho furniture range in 2010. He continued his success with L-Cube in 2015, and in 2016 presented c-bonded, a completely new technology and a very clean, clear-cut design.

Christian Werner

The virtuoso of form

In his work, Christian Werner likes to combine rationality with sensual quality. In all of his furniture designs, he tries to give emotions a shape of their own, to translate them into material.

Mr. Werner, what is the attraction in turning your attention from the living room to the bathroom for a while?

It's about our changing living habits. People used to spend as little time as possible in the bathroom and regarded personal hygiene as a necessary function that you got over and done with as quickly and unobtrusively as possible. Today, we are no longer so uptight about it. Personal hygiene has become a pleasurable focus of attention and so, in turn, has the bathroom. It has become a sensory space for regeneration, somewhere that we enjoy spending our time. The demands of this room are also increasing accordingly. So it's time to really think furniture into the bathroom.

Has your work with the bathroom changed your understanding of design?

It has changed me to the extent that it has reinforced the way I think about design. This is because I don't see myself as an artist. Art is art for art's sake whereas design has a purpose – and beauty is also a purpose. As a designer, you are an integral part of a comprehensive production chain; so it's important to take account of things such as material limits or manufacturing techniques. The positive thing about working for industry is that you don't find yourself in a vacuum. In terms of method, industry virtually gives you a wind tunnel and, as a designer, you have to think yourself inside this. I find this very positive and exciting for my work.

How can "popular" be reconciled with "design"?

Well, lots of people are afraid of too much design. At the end of the day, they want a piece of normality at a reasonable price. As a designer, you also have to be able to back pedal. So that people can identify with them, we need products that don't permanently scream "hello, here I am!". However, at some point, things start to get too simple and there's simply

"We need designs that aren't constantly screaming 'hello, over here!'."

nothing more left to take away without slipping into prosaic engineering work. As a designer, you then find yourself caught between banality and finesse. So the art is to reduce forms and concentrate their finesse to find their very essence. Like Ketho or L-Cube, they then stand out on the strength of their balanced proportions and discreet beauty. And become an integral part of a harmonious room.

For how long is it possible to identify with a product?

As the bathroom has an average lifetime of 15 to 20 years, the durability of the formal statement is still much more important than in other rooms. It's comparatively easy to replace a sofa or a container. However, when the eye has tired of bathroom furnishings, it's not so easy to do anything about it. A much greater effort is involved.



L-Cube in White High Gloss in combination with P3 Comforts asymmetric furniture washbasin.



L-Cube in Apricot Pearl High Gloss in combination with the tri-oval above-counter basins from Cape Cod.

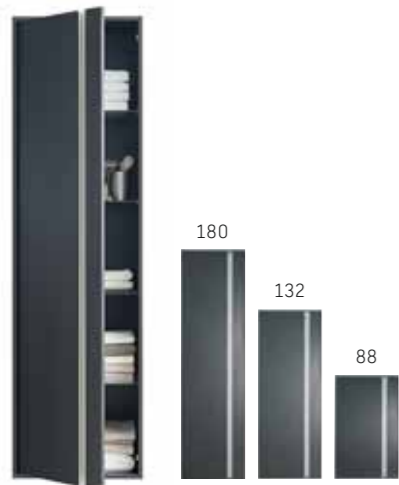

The tall cabinet is available in three different heights, in each case with Diamond Black interior.



As well as additional storage room, the mirror cabinet has an integrated socket and, like all furniture in the Ketho series, is available in 11 finishes. It is available in widths of 65, 80, 100 and 120 cm.



Big on design, small on price. With a bathroom furniture programme that is ideal for first-time buyers and has a reduced look making it completely at home in any modern bathroom.

Ketho

- Design** Christian Werner
- Bathroom ceramics** for combination with D-Code, Vero, Starck 3 or ME by Starck
- Bathroom furniture** in 16 different furniture finishes
- Interesting details** Ergonomic aluminum handles
- Guiding principle** Low budget – high standard

Aluminum handles that feel pleasant to the touch accentuate the horizontal lines – the lights of the mirror cabinet draw the eye upwards. Everything has

its place in the well thought-out interiors of the cabinets, shelves, mobile storage unit, vanity units and console solutions.



Colour
Taupe as décor



Washbasins can be either fitted from above or built-in. If the washbasin is fitted from below, the transition between ceramic and wood surface is seamless, making it particularly easy to care for.



Further furniture finishes from p. 194



Human touch
 The asymmetric furniture washbasin is 105 cm wide offering plenty of storage space (on the left or right-hand side). The soft, easy-clean ceramic transitions separate the wet and dry areas.



A perfect bathroom is one thing. Somewhere that takes every aspect of comfort literally and that combines practicality with emotion is quite another. Welcome to P3 Comforts.

P3 Comforts

Design Phoenix Design
Bathroom ceramics in White
Bathroom furniture L-Cube
Bathtubs in 5 sizes from 160x70 cm to 190x90 cm, with or without whirlsystem, shower trays made of DuraSolid® in 12 sizes from 90x80 cm to 160x100 cm, with a matching shower stool
Shower-toilet SensoWash® Slim
Interesting details Raised tap platform, large inner basin, asymmetric furniture washbasins, plenty of storage shelves, separation of the wet and dry area
Guiding principle Perfect comfort that is perfectly cool

People need places to which they can retreat to regenerate mind body and soul. That is why, in designing the P3 Comforts, Duravit and Phoenix Design took the name to heart – not only in its literal sense, but also in terms of the French word “conforter”, to strengthen. Because design satisfies some very fundamental human

needs, not only with regards to appearance and functionality, but also in terms of sensuality. It wants to be seen, touched and used – to fortify the user and appeal to the user's emotions. P3 Comforts satisfies these needs, and does so with a lightness of design.



Appealing forms, largest possible inner basin, rimless contour, maximum comfort due to the raised tap platform, plenty of storage shelves.



The rimless washbasin offers a pleasing look and feel and is extremely practical, as it allows for the largest possible inner basin which is easy to clean. Also available for the washbasin (60 cm or 65 cm in width) with siphon cover or pedestal.

Shower stool 35/38 cm wide and 42 cm high



The P3 Comforts shower tray made of the innovative slip-resistant DuraSolid® can be flush-mounted, semi-recessed or surface-mounted. The broad edge area also serves as a convenient shelf space. The outlet cover can be removed for easier cleaning. The shower tray can be combined with the OpenSpace and OpenSpace B shower enclosures from Duravit and any standard shower partitions.



The P3 Comforts acrylic bathtub, shown here as a freestanding version with seamless acrylic panel, is spacious enough for two. The bathtub is available in back-to-wall, corner left, corner right and built-in versions.

The P3 Comforts toilets: 2 cm wider than standard, with or without a SensoWash® Slim shower-toilet seat, with automatic closure, particularly easy to clean and economical with water thanks to the innovative Duravit Rimless® flushing technology.



The pleasantly soft neck rest increases comfort for the bather – as does the optional Duravit whirlsystem. The control panel for this system is located on the slightly raised tub rim, which is wide enough to be used as a shelf surface.

Combined with the Rimless® toilet from the P3 Comforts range, SensoWash® Slim offers even greater sitting comfort and a unique, fresh feeling.



Perfect details

As true beauty is only really revealed in the small details, Vero bathroom furniture and ceramics prove to be real stunners. One example is the horizontal grain of the real-wood veneers, such as Mediterranean Oak, which creates a subtle contrast with the vertical chrome handles. Another are the mitre-cut and thus particularly durable edge joints. And as for sophistication: the optional LED ambient lighting accentuates Vero's qualities in a decidedly understated way.

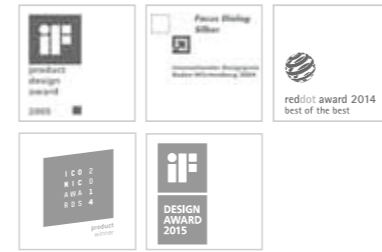

Not without reason is the Vero ceramic series a modern design classic: its style, consisting entirely of rectangles, is extremely elegant and timeless.

Vero



Design Duravit / Kurt Merki Jr. (Bathroom furniture)
Bathroom ceramics in White and Black
Bathroom furniture More than 30 variants, including White High Gloss, American Walnut, Mediterranean Oak, Oak Cashmere
Bathtubs Bathtubs in 4 sizes, from 170x70 cm to 190x90 cm, with or without whirlsystem
Interesting details Sword-like handles, organizer systems for vanity units, tall cabinet front as a mirror door, integrated or side-mounted towel rail, LED light source with luminosity of over 300 lux, optional dimmer function, consoles with LED ambient lighting
Guiding principle Consistency and comfort come together

Launched as an individual washbasin range with three models, Vero is now turning heads as a full range – with timeless design and all the components you need for a complete bathroom. From the handrinse basin, above-counter basin through to furniture washbasins including the perfectly coordinated bathroom furniture and chrome frames; with various toilet and bidet variants and matching bathtubs. The classic shape is highly memorable.



It needn't necessarily always be white. Trend researchers are already seeing black as the colour of the decade. Hardly surprising: Vero in Black High Gloss has a sophisticated, graceful and contemporary effect – and is perfect for combining with vanity units in Oak Anthracite or chrome frames. The resulting bathroom is exclusive and timelessly modern.



Founded by the architect Dieter Sieger, the design studio has become one of the world's most successful in the bathroom segment and is now run by his sons Michael and Christian Sieger. Sieger Design is behind the successful ranges such as 2nd floor, Darling New, X-Large and Happy D.2. The creative agency also works for and with brands such as Lamy, Ritzenhoff and Fürstenberg Porzellan.

sieger design

Everything in flux

The fact that Duravit is now able to fill bathrooms around the world with life has a lot to do with Dieter Sieger. In 1990, his "Darling" bathroom range for Duravit set the bar for design-oriented bathrooms. Its success changed an entire segment.

sieger design is regarded as a bathroom specialist. Is that also how you see yourselves?

M. Sieger: If Sieger Design stands for one product area, then it has to be the bathroom. Because we have now dedicated more than 30 years to this particular room of the house. I don't believe there's another design agency in the world that has such a long track record with the sanitary segment and the bathroom.

You motto is "Everything in flux". What do you mean by that?

M. Sieger: I think that's what makes our profession special: the fact that we are constantly looking at issues of where the journey is going, how things will change in future. Nothing is as it seems, and nothing will remain as it is. Over recent years, we've seen a trend towards the acceleration of processes. And we engage with this change day in, day out.

A further key issue for Sieger is sustainability.

C. Sieger: We want to inspire the industry, which ultimately offers the product to the customer, to think about the issue of sustainability. The best product is actually one that we end up not producing. For that reason, the issue is to create high-quality, sound products that are not only sufficiently well-made to keep going for as long as possible – after all, you can say that of many cheaper products nowadays – but that we can enjoy for many years. Things that we enjoy,

that help us live the lifestyle we want, that can also perhaps be modified so that we don't need to keep replacing them. As humans we simply cannot afford to keep using as many resources as we have in the past.

Happy D. is still a bestseller, and 2013 saw a reinterpretation. How do you go about refining and further improving such a process, something that already has its own tradition?

M. Sieger: Subjecting products that have been around for a few years to a redesign is a highly attractive opportunity. The original Happy D is without a doubt still a great product, but the market and habits have changed. Products are becoming more delicate and airy. We may well be going through a paradigm shift: In the past, things that were valuable and precious had to be heavy and contain large quantities of valuable material. I think that will be different in future. Luxury goods are increasingly products that are very lightweight and that only need small amounts of material to be made.

For you personally, what does luxury in the bathroom mean?

M. Sieger: My personal luxury in the bathroom is that I don't actually have a proper bathroom any more. Not because I've stopped washing, but because my bathroom has fused to become a single room with my bedroom and dressing room – similar to what we have seen in the kitchen area, which has opened out into the dining room or living room. In my room I can carry on talking to my wife if I'm still in bed and she's at the washbasin. For me, this open spatial concept represents day-to-day luxury because it quite simply enables greater communication.

"Demand what seems impossible to achieve the extraordinary."

Michael Sieger





The fine, rounded corners feature throughout the bathroom programme – and give Happy D.2 its distinctive, archetypal design. The back-to-wall bathtub also adopts the typical radii of the ceramics, particularly characteristic in combination with the all-round rim. Taking a bath is especially comfortable with the optional neckrest. Feminine charm and pure sensuality – Happy D.2 offers timeless modernity.

Feminine charm and pure sensuality – Happy D.2 offers timeless modernity.

Happy D.2

Design Sieger design

Bathroom ceramics in White, 12 washbasin variants

Bathroom furniture with 6 different finishes, also in real wood veneer or linen-look decor finish

Bathtubs Bathtubs in 5 sizes, from 160x70 cm to 190x90 cm, with or without whirlsystem

Shower-toilet SensoWash® Starck C and SensoWash® Slim

Interesting details The ceramic contour is carried over on to the furniture, monolithic bathtubs, LED light source with luminosity of over 300 lux, optional dimmer function, organizer system for washbasin vanity units, bathtubs with a range of whirlsystems

Guiding principle Elegance is timeless

Gently rounded edges and clear, geometric forms create a gracefully composed, complete bathroom that has won multiple awards. Happy D.2 brings a pleasant tactile sensation into the bathroom with its "Linen" textile décor. The smart furniture washbasin comes in five widths with a delicate chrome handle and six finishes, optional chrome feet. Alternatively, the range also includes above-counter basins for appealing console solutions. All in all: a supremely elegant bathroom series.



Furniture washbasin and vanity unit in linen décor finish – humidity-resistant like all Duravit furniture finishes.

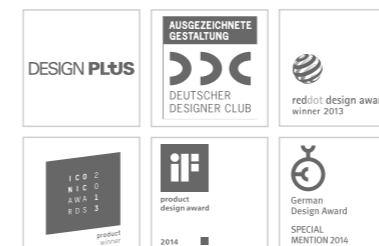



The washbasin's height-adjustable chrome console is the ideal place to hang a towel. The freestanding bathtub is available with and without a whirlsystem.



Two drawers provide plenty of space for all washing and personal-hygiene essentials. A high-quality and practical diamond-black interior helps keep things tidy.



SensoWash® Starck C



SensoWash® Slim



Toilets and bidets are available as wall-mounted, stand-alone and back-to-wall variants, both with and without soft closing mechanism. They can be combined with the SensoWash® Starck C and SensoWash® Slim shower-toilet seat.





Rounding things off
The Darling New bathroom classic with delicate contours, harmonious circular shape in variants with siphon cover or pedestal.

It's all in the name: The design classic from sieger design, with the unmistakable delicate edge and harmonious circular shape. There's a good reason why it's "Everybody's Darling". The matching L-Cube bathroom furniture is just as popular.

Darling New

Design sieger design
Bathroom ceramics 25 models in White, 4 washbasin variants
Bathtubs Bathtubs in 5 sizes, from 160x70 cm to 190x90 cm, with or without whirlsystem
Shower-toilet SensoWash® Starck C and SensoWash® Slim
Interesting details Optional LED lighting beneath the bathtub rim
Guiding principle Lots of class at a small price

The washbasin's winning features include spacious storage shelves and a deep inner basin. The exquisite design can also be found on the washbasin version with siphon cover or pedestal and suffuses the full Darling New bathroom programme.

The gentle shimmer of the optional LED lighting beneath the all-round rim creates a very special bathroom atmosphere. The comfortable, 11.5 cm-wide bathtub rim affords an additional comfortable sitting or storage area.



The innovative connection of ceramics and furniture

Darling New c-bonded
The Darling New furniture washbasin by sieger design and the L-Cube low cabinet by Christian Werner form a perfect harmony. And all because of the new c-bonded technology. The furniture starts exactly where the ceramics end – craftsmanship down to the last millimetre. The join between the two materials is durable, seamless and waterproof. The result of two washbasin widths, floor-standing and wall-mounted vanity units and 31 finishes is a wide range of precise, minimalist options for the individual washing area.



Toilet wall mounted and SensoWash® Slim



Closed side surfaces conceal the attachments. Available in different variants as a floor-standing, wall-mounted and back-to-wall version. Equipped with SensoWash® technology and HygieneGlaze 2.0 ceramic glaze, this state-of-the-art toilet has an almost natural antibacterial effect.





X-Large combines extra-large storage space with an elegant form and tremendous flexibility for lots of different configurations. Delicate contours, ingenious shadow gaps and a mix of open and closed fronts create bathroom furniture that offers more than meets the eye.

X-Large

Design sieger design

Bathroom ceramics can be combined with the ceramics from the Darling New, Starck 3 and Vero ranges and all above-counter basins

Bathroom furniture with 35 different finishes, including real wood veneers and lacquer

Details Consoles in a range of widths and 2 depths (48 and 55 cm), all with an extra-fine front-edge contour

Guiding principle Slimline storage expert for small and large bathrooms

The tremendous flexibility of the extra-broad X-Large is impressive. Large and small back-to-wall, corner and niche solutions can be easily installed in a modular fashion. We also produce consoles and matching vanity units in two optional depths.

Further well-thought-out design variants include for example the delicate light canopy with glare-free illumination over 300 lux, the narrow aluminum handles and the matching bathtub panels.



Bathtubs



Furniture basins

The perfect match: Ketho vanity unit, furniture finishes see p. 194



Washbasins



Corner bathtub



Accessories from p. 130



Shower trays



Normal



Compact

With variants and solutions for all conceivable room layouts, D-Code is the range for absolutely any situation – the key to an attractive, affordable design.

D-Code

Design sieger design

Bathroom ceramics in White, furniture washbasins can be combined with vanity units from DuraStyle, Ketho and X-Large ranges

Interesting details Complete series with matching accessories

Guiding principle The range for all cases

The series is visually understated – a rectangle with rounded corners, the quintessential washbasin. The discreet forms do not impose themselves but blend into their surroundings. That's what makes

D-Code so timelessly modern – another feature of good design. With variants and solutions for all conceivable bathroom situations, with the matching accessories series of the same name.



D-Code

Always a perfect fit

In the bathroom, accessories with a uniform design are the finishing touch. D-Code proves that quality and design do not have to be expensive. Here, premium accessories, including paper holder, towel and bath towel rail, brush set and cosmetic mirror are available at a great entry-level price.



Towel shelf
009925

Cosmetic mirror with
triple magnification
009912



Bathtub handle
009914

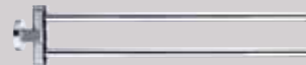

Towel rail
009922



Bath towel rail 60 cm
009924



Bath towel rail 80 cm
009923



Glass holder
009920



Soap dish
009917



Soap dispenser
009916



Spare paper holder
009915



Paper holder
009926



Towel hook
009904



Towel ring
009921



Brush set
009928



Brush set
009927



Towel shelf
009962



Cosmetic mirror with
triple magnification
009912



Glass shelf
009950



Bathtub handle
009963



Towel hook
009904



Bath towel rail 60 cm
009959



Bath towel rail 80 cm
009960



Soap dish
009952



Soap dispenser
009954



Glass holder
009951



Soap basket
009953



Spare paper holder
009956



Paper holder
009955



Brush set
009957



Towel ring
009961



Towel rail
009958

Karree



Cubist beauties

Classic materials, durable workmanship, compact form: the straight-lined Karree accessories made of chrome and satin-finish glass harmonize with virtually all design series and are easy to install. With their small radii, they also fit where space is at a premium.



Modern Vintage

The 1930 Series is named after the year in which it was first presented. Its opulent and yet geometric design brings the Golden Twenties to life in the bathroom. For example, the washbasin with the narrow, all-round rim stands on an octagonal pedestal with a base resembling the plinth of a sculpture.

A modern interpretation of traditional country living. With sanitary ceramics that transform the bathroom into a comfortable place of retreat and that bring the country style into the twenty-first century with contemporary functionality.

1930 Series

Design Duravit

Bathroom ceramics in White

Interesting details Washbasin with the typical octagonal design, which was first presented in 1930

Guiding principle Elegant country living is always in season

The striking, octagonal basic form is typical of the design of the 1930 Series. Since ancient times, the octagon has symbolized perfection. Nevertheless, over the last few decades, Duravit has continued to find things to improve: today, modern technology is concealed behind the nostalgic form so, although the

country-house style harks back to the good old days, the comfort is that of the modern day. All surfaces can be finished with WonderGliss, an extremely smooth coating that is burned into the ceramics and that doesn't allow dirt or limescale to secure a hold.



And yet, however consistently classic the look of the 1930 Series is, it still represents cutting-edge technology, as exemplified by the floor-standing bidet and toilet. The bidet and toilet are also available as a wall-mounted version. Both toilets have a 6 litre flush.





Matteo Thun is one of the most important Italian architects and designers. Former member of the "Memphis" design group and Creative Director of "Swatch", will tackle the most diverse design tasks – from sunglasses to cogeneration plants. He and his partner Antonio Rodriguez designed the DuraStyle bathroom range.

Matteo Thun & Antonio Rodriguez

The hotel bathroom as trendsetter

A bathroom needs to live up to a wide range of requirements and uses – day in, day out. It was this holistic approach that gave rise to the DuraStyle series.

The name Matteo Thun stands for environmentally-friendly architecture, sustainable design and building materials that are in harmony with nature. Do these aspects also predominate when designing hotels and hotel bathrooms in particular?

Aesthetic, economic and technological sustainability form the basis for our work – both in architecture and design. Sustainable design is important for hotel projects in particular – on cost grounds as much as anything else. A project has to guarantee a lifecycle of 10 to 15 years because no investor wants to pay for a complete renovation every five years. And, as an architect, I have an ethical obligation, also towards the investor. We believe it's important that our projects make economic sense.

Which materials do you favor?

Our motto is high-touch, not hi-tech. We therefore prefer natural and untreated materials, such as wood and natural stone. Natural materials increase our feeling of well-being. Not only do they improve the interior environment, they also appeal to our sense of touch. This experience brings the individual closer to their environment and to themselves, and changes the way they react to them. Our bathrooms don't have any high-gloss surfaces, high-gloss marble or stones that have been polished to a high-gloss level. We have one simple rule: the materials have naturally split or fractured surfaces and are sandblasted and then waxed.

What ideas motivated you when developing DuraStyle?

Every person uses the bathroom in his or her own unique way – individual requirements vary greatly and place high demands on the flexibility of bathroom furnishings. We asked ourselves what a contemporary and sustainable bathroom programme must offer in order to best meet all requirements and cater for all applications. We take a holistic approach to our projects and look for the point where product design, architecture and interior design intersect. As a consequence, DuraStyle is a bathroom range that is not full of itself, but rather leaves space for individualization.

"Everyone uses the bathroom in their own way."

Matteo Thun



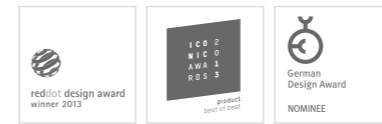

The fine signature of Italian design.
Tremendous design freedom.

DuraStyle

Design Matteo Thun & Antonio Rodriguez
Bathroom ceramics in White
Bathroom furniture with 18 different finishes, for example White High Gloss, Basalt Matt or American Walnut solid wood
Bathtubs Bathtubs in 6 sizes, from 140x80 cm to 190x90 cm, with or without whirlsystem
Shower-toilet SensoWash® Starck C and SensoWash® Slim
Interesting details Attractive washbasin-furniture combinations, furniture as accessories
Guiding principle Big on style, small on price

High functionality and the familiar Duravit quality, plenty of scope for combination and composition. And all this at an extremely affordable price. The overall range affords impressive functionality with its well-harmonized products – both in private bathrooms and in the project sector. Two finish variants – light and dark –

present even more options. Characteristic: The narrow, delicate basin rim and the downward taper of the outer edge of the toilets lend the ceramic airiness and style. This is complemented by the flat cover/seat combination or one of the SensoWash® Starck C or SensoWash® Slim shower-toilet seats.



In the Rimless variant, the innovative flow of the flushing water delivers an optimum result, even when used economically. At the same time, Rimless toilets are particularly hygienic and easy to clean.



SensoWash® Slim SensoWash® Starck C Basic Duravit Rimless® Toilet close-coupled Toilet close-coupled Toilet close-coupled Nordic toilet version



More options

This bathroom series features rounded edges and rims. According to designer Matteo Thun, a programme "that is not just about design but that is also fully functional". With the large range of variants and dimensions, the bathroom ceramics and furniture adapt to every room size and style. The series is just as flexible in terms of budget.



The washing area can be cleverly put together. It develops its own unique character, depending on whether the washbasin is fitted in a console, has a closed vanity unit in the form of a cube, or is combined with a piece of furniture.





Normal

Compact



How can we style the washing area? For example, a washbowl either 43 or 60 cm wide with matching vanity unit 100 or 140 cm wide. Or a built-in or above-counter basin with a width of 43, 56, 60 or 61.5 cm. Bathroom furniture with a mix of closed and open fronts creates an airy overall impression with both light and dark shades.

This also applies to the delicate furniture accessories made of real wood in European Oak that provide attractive support for the DuraStyle washbasins. The DuraStyle carcasses are also available in White Matt or Basalt Matt, regardless of the front colour.



DuraStyle as an above-counter basin solution in 43 and 60 cm







Bathroom Foster

The oval washbowl is perfectly suited to all consoles that seek to demonstrate their timeless modernity.

Duravit is not only the favorite of many architects: various individual products were actually designed by renowned architects such as Lord Norman Foster or Frank Huster.

Rigorously derived from clear geometric shapes at the formal level, these washbasins and above-counter washbasins provide a range of pared-down solutions for bathrooms that transform architecture into an experience.

Architectural highlights



Architec

The circle and the square as basic forms. A designer bathroom collection that gains surprising variety from architectural rigor: 18 washbasin versions, even including wheelchair-accessible variants. A design classic developed by Prof. Frank Huster.



Scola

Inspired by the washbasins in classrooms, the deep inner basin offers plenty of room for washing hands. There's even enough room for an atlas on the wide shelf at the side! The washbasin with chrome frame is an architecturally interesting alternative to a wall-mounted version.



This is just a small selection of that we have to offer, you will find more in the individual ranges or at www.duravit.com.

A freshly made bed, the air after a shower of rain, white cotton - the feeling of cleanliness and freshness is wellness for the senses. And the best thing is: it's really easy to integrate into any bathroom and toilet.

Toilet comfort and hygiene

The SensoWash® shower-toilet line stands for the most natural form of hygiene possible. Nothing is as thorough, as natural and as refreshing as cleansing with water, also after using the toilet. This is why shower toilets - a combination of toilet and bidet - are becoming increasingly popular. SensoWash® offers greater comfort and quality of life. A discreet and attractive design also plays a key role.

For that reason, the user's individuality was emphasized during the development: The SensoWash® shower-toilet seats are available in two comfort levels and can be combined with many Duravit bathroom ranges. On all models, an integrated flow heater ensures that resources are used intelligently, as the required amount of water is only heated to the required temperature as and when needed.

A sense of sheer well-being and an optimum design.



- 148 **SensoWash® Slim**
- 150 **SensoWash® Starck C**
- 152 **Duravit Rimless®**
- 154 **HygieneGlaze 2.0**
- 156 **One-, two-piece toilets**



Vero Air

Attachment system

The Durafix attachment system is particularly quick and easy to install and also completely invisible. The water and electricity connections run through the ceramic without being seen.



An instant heater heats the water as and when required, and only in the necessary quantity.



Easy to clean

The cover made of the robust material Urea with its non-porous and highly scratch-resistant finish is easy to remove. SensoWash® Slim can also be combined with Rimless.



The minimalist shower-toilet matches eight design series. Perfect personal hygiene, high operating comfort.

SensoWash® Slim



-  Rearwash
-  Ladywash
-  Comfortwash
-  Soft-closing mechanism



The nightlight function provides orientation and safety.

Perfect personal hygiene

SensoWash® Slim is perfect for all those who place importance on the essential functions of a shower-toilet and appreciate purity in style. The flat lid/seat combination is an innovation in form – and gives the ensemble the appearance of a normal, yet elegant, toilet. High functionality and ease-of-use make SensoWash® Slim the ideal shower-toilet, both for shower-toilet beginners as well as for advanced users who delight in design and quality.

All key functions can be operated comfortably and intuitively via the slim remote control: Water temperature, water spray intensity and the spray wand position can be individually adjusted. The magnetic fixture enables the remote control to be easily detached from its cradle (supplied).

SensoWash® Slim – perfect personal hygiene, matches eight design series. And all this at an attractive price.



The intelligent shower-toilet that meets the highest requirements.

SensoWash® Starck C

Design by Philippe Starck



Built-in intelligence

With SensoWash® Starck C, Duravit and Philippe Starck have created an extraordinary shower toilet seat. The timelessly modern shape is an embodiment of the high standard placed on form. "C" represents "concealed connections," as the water and electricity lines are concealed within the ceramic, remaining invisible.

SensoWash® Starck C fits perfectly with toilets in a wide variety of Duravit series, and maintains a seamless look – a visual continuation – of the ceramic with which it is paired. Highly functional and easy to use, the shower-toilet seat offers maximum comfort and practicality.



-  Rearwash
-  Ladywash
-  Comfortwash
-  Replacement shower nozzle
-  Warm Air Dryer



Standard spray nozzle Soft-jet spray nozzle



The SensoWash® Starck C shower-toilet seat comes as standard with two spray nozzles that can be quickly and easily switched. Each spray nozzle has two different nozzle outlets that can be activated, and from which fresh water streams at the perfect temperature. The interchangeable spray nozzle also offers an extra-gentle soft-jet function.

Comfort on top

All functions are operated by remote control. The buttons light up when selected, intuitively displaying for example the individual temperature of the seat or water or the required shower function and position. Toilet seat and cover are also activated via an electric motor operated by the remote control.



Easy installation without visible elements using the patented Durafix attachment system. Other invisible elements include the water and electricity connections that run through the ceramic without being seen.



An instant heater heats the water as and when required, and only in the necessary quantity.



When it's dark, a special LED night light function provides orientation and safety, without interrupting the body's repose.



DURAVIT

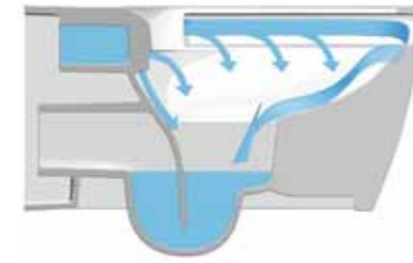

Pure efficiency for toilets and urinals.

Duravit Rimless®

- Optimized design of flushing rim and geometry of the bowl geometry for dynamic water flow and optimum surface flushing
- Fully-glazed, extremely smooth ceramics prevent the formation of germs and the build-up of residue
- Quick and easy to clean, lower cleaning times, less cleaning material
- Intelligent geometry enables a water level of 16 mm above the specially shaped inner contour
- Less soiling due to a large water surface
- Innovative water flow even with a rectangular external shape, resulting in perfect flushing of the inside surface, excellent flushing results even with small water volumes
- Compatible with all modern cisterns

Innovative flushing technology

Duravit Rimless® features impressive performance, efficiency and hygiene – now not only with its toilets, but also urinals. The open design of the toilet rim enables a new type of flushing action: resulting in a dynamic and powerful flow of water that rinses the entire inner surface of the bowl. This ensures perfect and hygienic flushing results, even with smaller volumes of water.

Environmentally-friendly sustainable

Thanks to the open, easily accessible rim area, the bowl is particularly easy to keep clean, and this reduces cleaning times and the use of cleaning materials considerably.

In the practical test of the specialist sanitary magazine sbz, the Darling New wall-mounted toilet was the best in test with the top score of 1.9.



99.999 %
antibacterial

DURAVIT



Duravit sets a new standard of hygiene. The antibacterial ceramic glaze for toilets and urinals.

HygieneGlaze 2.0

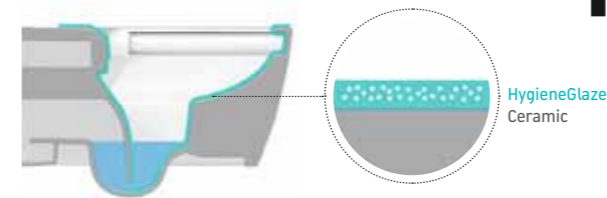

Duravit has a new and effective answer to the question of how to improve hygiene in toilets and urinals: HygieneGlaze 2.0. The innovative ceramic glaze has been further developed and now has a new formula. The new HygieneGlaze 2.0, which is baked into

the ceramic during firing, is not only especially effective, but also acts very quickly. After just six hours, 90% of bacteria are killed and after 24 hours 99.999% have been eliminated, an unprecedented level.



The graph shows the growth of bacteria and germs (E.coli/fecal bacteria) on standard ceramics and on HygieneGlaze 2.0 ceramics. On HygieneGlaze 2.0 ceramics, the number of colony forming units has been reduced by 99.999 % within 24 hours.

Tests by the Institute for Hygiene and Public Health at the University of Bonn confirm that HygieneGlaze 2.0 kills an almost unprecedented 99.999 % of germs.

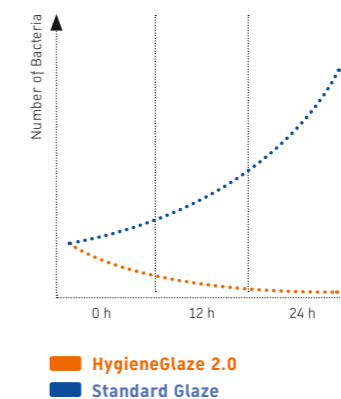

HygieneGlaze 2.0 is available for all toilets and urinals in the Architec, Darling New, D-Code, DuraStyle, Happy D.2, ME by Starck, P3 Comforts, Starck 3 and Vero Air ranges.

- Architec
- Darling New
- D-Code
- DuraStyle,
- Happy D.2
- ME by Starck
- P3 Comforts
- Starck 3
- Vero Air

One-piece toilets



DuraStyle with SensoWash® Slim

Two-piece toilets



1930 Series



Darling New



D-Code



DuraStyle



Happy D.2



Happy D.2



ME by Starck



P3 Comforts



Starck 3



Darling New



D-Code



DuraStyle



Happy D.2



Me by Starck



P3 Comforts



Starck 2



Starck 3



Vero



ME by Starck with SensoWash® Slim

Wellness for mind, body, soul and your home:
Pure relaxation for the body, revitalization for the soul.

Wellness & health



DuraSquare
Design by Duravit

Whether a conventional bathtub, bathtub with whirlsystem, shower or sauna. Attractive, comfortable and well thought-through. Bathtubs that are perfectly adapted to the body, materials that are appealing to the eye and to the touch, technical features that don't get in the way, but intuitively facilitate relaxation. For example, the Air-system for bathtubs. Almost invisible, but with a tangible effect. Or the drainage rate of our showers. Gently curved and flush-mounted, semi-recessed or surface-

mounted, up to 36 litres per minute can easily be drained away. A sensation to the touch, from simple, smooth acrylic through the seemingly soft DuraSolid® A to an archaic feel such as the natural-stone showers with DuraSolid® Q and Stonetto. Plus a sauna solution for large and small bathrooms with a round stone as control element. Nothing gets in the way. Everything is in flux and you immerse yourself in warm water, fresh rain showers or vibrating heat, gather your energy for coming challenges and pamper yourself.

I like to be happy.



- 160 **Bathtubs & Whirlsystems**
- 168 **Shower trays**
- 178 **Sauna**



Tremendous freedom

Not without reason is a freestanding bath regarded as the very essence of a spacious bathroom. As a stand-alone unit, it is ideal in open room concepts and complements top quality architecture. When bathing, it conveys an incomparable feeling of freedom. There are two different materials to choose from: DuraSolid® and acrylic. Which bathtub fits which whirlsystem? Overview p. 167.



Blue Moon

With acrylic paneling or wood paneling. Alternative: Wooden insert in Teak.



Cape Cod

Spectacular: The unusually delicate sides of the tub and organic forms ensure aesthetic enjoyment. Maximum comfort is guaranteed by the material DuraSolid® and the integrated storage shelf that can be used as a headrest.

DuraSquare

Straight-lined. Organic. The freestanding bathtub made of DuraSolid® takes up the typical radii of the ceramics. The smooth inner contour forms an aesthetic contrast to the exact geometry of the exterior.

Luv

Oval basic form, gently curving lines, generously-proportioned interior and surprisingly thin bathtub edge. Seamlessly manufactured from the innovative material DuraSolid®, the bathtubs impress with their high-quality matt aesthetic and pleasantly warm feel.

Happy D.2

Fine radii, rounded edges and clear geometric forms lend the Happy D.2 bathroom range an unmistakable style. Here with acrylic paneling, 180x80 cm. Optional with neck rest.

Starck

Duravit Starck – the classic – is made from sanitary acrylic. The minimalistic, pure bathtub is available in dimensions 180x80 cm or 190x90 cm, as well as with two sloping backrests.

Vero Air

Architecturally linear. The freestanding Vero Air bathtub is presented as a perfect rectangle. By optimizing the radii and wall thicknesses (55 mm), the iconic design is also reflected in the monolithic form of the acrylic bathtub.





DuraSquare

Freestanding bath tubs

The significance of wellness is growing – as too is the use of freestanding bathtubs. If space permits, a freestanding bathtub can be both a wellness centre and an eye-catching feature. Ideal: the freestanding bathtub tap fitting C.1.



P3 Comforts

Built-in bathtubs

Planning optimal utilization of space, slanting ceilings or additional storage shelves? A bathtub of the built-in type (here P3 Comforts) can realize all comfort needs.



Luv

Corner bathtubs

Maximum utilization of space – even where space is tight. Duravit offers corner bathtubs in all conceivable designs and sizes.



Cape Cod

Back-to-wall bathtubs

Classic, characteristic in design, ideal and flexible for room layout.

All bathtubs are optionally deliverable with different whirlsystems. Depending on designed in DuraSolid® or acrylic.



Spacious and comfortable

Paiova 5 combines all the advantages of a corner bathtub with those of a freestanding tub – requiring much less space for installation while still conveying a spacious feeling. There are two permanent, different backrest slopes, 40° and 46°, which are an open invitation to either sit or lie back and relax. The layout of the tub even allows two people of different heights to find good support for their feet. Paiova 5 comes in two sizes, 177x130 cm and 190x140 cm, in corner left or corner right versions, all with optional whirlsystem. Further forms and sizes: www.duravit.com/paiova.





Much too nice just to use for bathing. With our practical and attractive covers, they can be instantly transformed into a relaxing lounger, convenient storage area, changing mat or seat – even a relaxing foot spa.

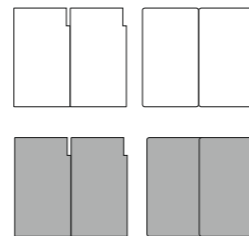

The sturdy covers come in sets of two individual units, in the colours White or Anthracite. With or without a recess on the side for the shower head.



Darling New bathtub with acrylic panel



Mobile, easy to use, uncomplicated
The remote control can be used to operate all the colours in a Duravit bathtub. With a graphic, comprehensible design, operation is as easy as with a television.

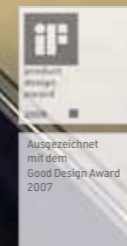

Blue Moon showcases the bathroom. Ten LED spotlights, six colours and five coloured-light programmes can be used to create just the right atmosphere.



Light in the tub

More colour in everyday life: Five LED lights with integrated colour light set into the sides of the bathtub provide optimum comfort and atmospheric light. White light, six pre-set colours and five coloured-light programmes can be selected by remote control and dimmed as required. An additional base is not needed as the bathtub comes fully assembled.



Whirlsystems enable optimum wellbeing*

Air-System The flat, white base jets on the Duravit acrylic bathtubs have a diameter of just 8 mm. They are even more inconspicuous on the DuraSolid® Duravit tubs as they are integrated directly into the base of the bathtub in tiny, almost invisible holes. They can be switched on and off via a flat, discreet one-touch operating and both variants offer a pleasant massage to the bather by adding air. They are operated using a Piezo switch.



Jet-System Six flat water-air nozzles arranged in the side wall create a beneficial, powerful massage effect. The intensity of the massage jet is regulated via an air controller on the rim of the bathtub. The Jet-System can be customized by adding the LED coloured light module.



Combi-System P The positive action of the Air-and-Jet-System is combined in the Combi-System P. In addition, the Combi-System P is also fitted with four back-massage jets. It is operated via a pneumatic switch and an air control fitted on the rim of the bathtub. The Combi-System P can be customized by adding the LED coloured light module.

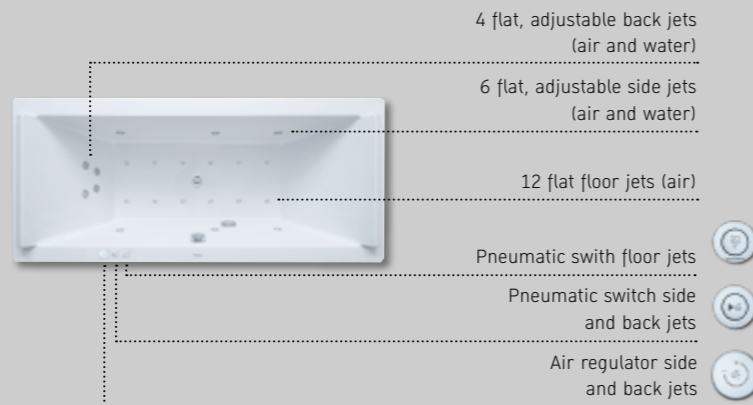

- LED coloured light
- LED white light
- Temperature
- UV hygiene management
- Swivel massage
- Air massage
- Durapearl massage
- Side massage
- Foot massage
- Back massage



Combi-System E The electronic control of the Combi-System E offers an especially high standard of comfort: all regular functions of the systems Air, Jet, the back and foot massage and LED white light can be easily and comfortably operated using a compact integrated controller. The Combi-System E can be individually expanded with additional modules such as heating, LED coloured light and UV hygiene management. A changer can be used to concentrate the force of the pump on the feet and back jets.

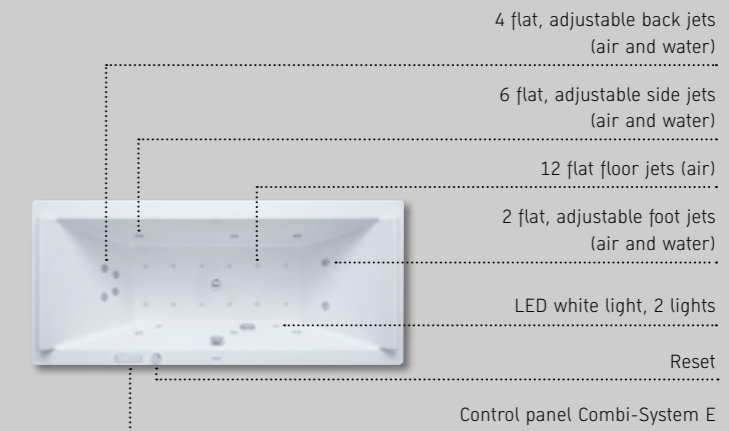

Combi-System L The state-of-the-art touch panel, surrounded by a chromed metal frame and icons with LED backlighting, affords a high level of comfort. All jets, for example the four flat swivel jets with the roving water jet as well as the two LED white-light sources, can be operated quickly and easily. The Combi-System L can be individually extended to include the additional LED coloured light, heating and automatic UV hygiene management modules.

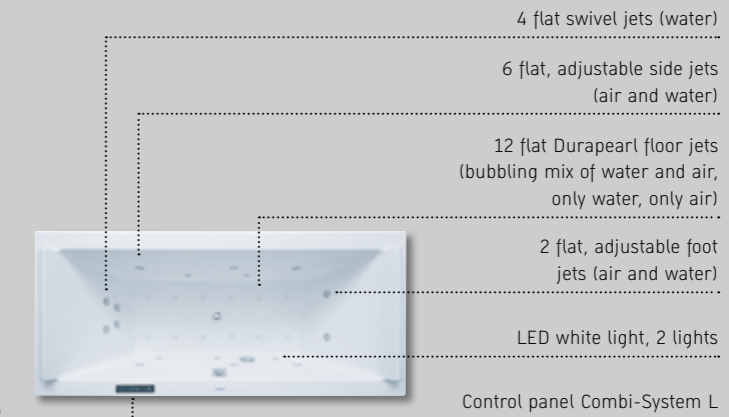

Bathtubs / systems	Air-System	Jet-System	Combi-System P	Combi-System E	Combi-System L
Blue Moon		•		•	•
Cape Cod	•				
Darling New	•	•	•	•	•
DuraSquare	•				
DuraStyle	•	•	•	•	•
Happy D.2	•	•	•	•	•
Luv	•				
P3 Comforts	•	•	•	•	•
Paiova	•	•	•	•	•
Starck	•	•	•	•	•
Vero	•	•	•	•	•
Vero Air	•	•	•	•	•



*Table shows standard whirlsystems. For further information about series specific whirlsystems please see price list or on www.duravit.com.



Stonetto

Design by E00S

The **Stonetto shower tray** communicates an entirely new, archaic shower sensation. Inspiration from the E00S design group: a stone surface worn and formed by water. Created in its entirety from DuraSolid®, the shower area and outlet cover form a single visual unit. The result: a surface that not only looks like stone, but is also just as hard. Pared down to the essentials, the shower tray slots seamlessly into the surrounding architecture.

As well as other solutions, it harmonizes perfectly with the OpenSpace and OpenSpace B shower enclosures. What's more, the geometry of Stonetto is designed for today's powerful comfort and rain shower heads.

Stonetto offers an anti-slip surface (class B) with the new DuraSolid® material. It can be installed flush with the floor, semi-recessed or floor-mounted.



The matt finish made from DuraSolid® is scratch-resistant and robust. The outlet cover integrated into the design can be removed and is very easy to clean. Stonetto can be combined with OpenSpace, OpenSpace B or any standard shower enclosures.

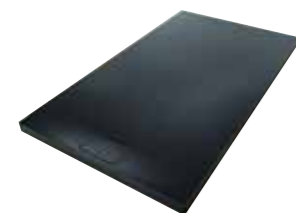

Anthracite



Concrete

Suitable for any room size: Stonetto is available in the sizes 90x80 cm, 90x90 cm, 100x80 cm, 100x90 cm, 100x100 cm, 120x80 cm, 120x90 cm, 120x100 cm, 120x120 cm, 140x80 cm, 140x90 cm, 140x100 cm, 160x90 cm, 160x100 cm, and in four colours.



Sand

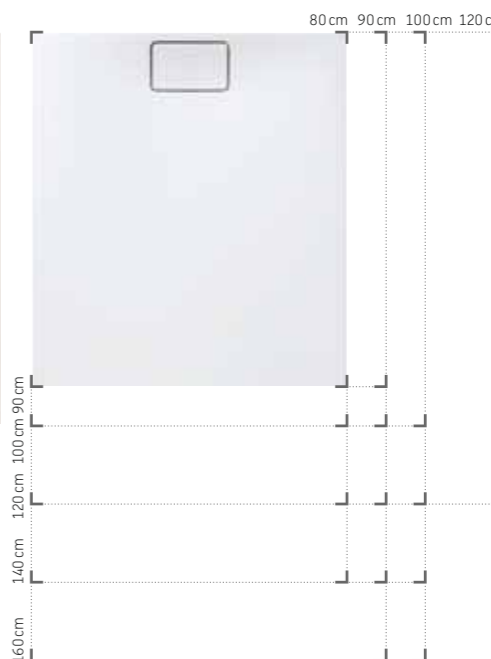

A GENTLE HOLLOW, AS IF ERODED BY WATER.

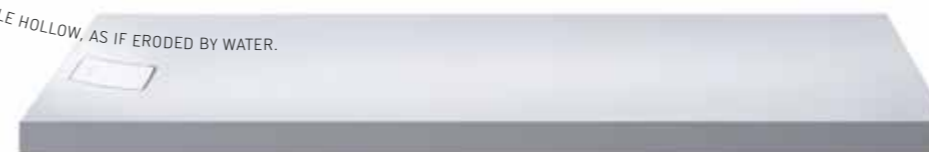

White

To ensure that Stonetto is suitable for combination with as many styles of bathroom and tile designs as possible, the shower tray is available in either White, Sand, Anthracite or Concrete. The tray is made from premium DuraSolid® with full-body colouring. It can be installed flush with the floor, semi-recessed or on the floor tiles. As the shower tray is self-supporting, it can even be installed without a support frame. The carefully designed incline and patented new outlet guarantee the perfect balance between a level surface and a high drainage rate. The concealed outlet is easily accessible.

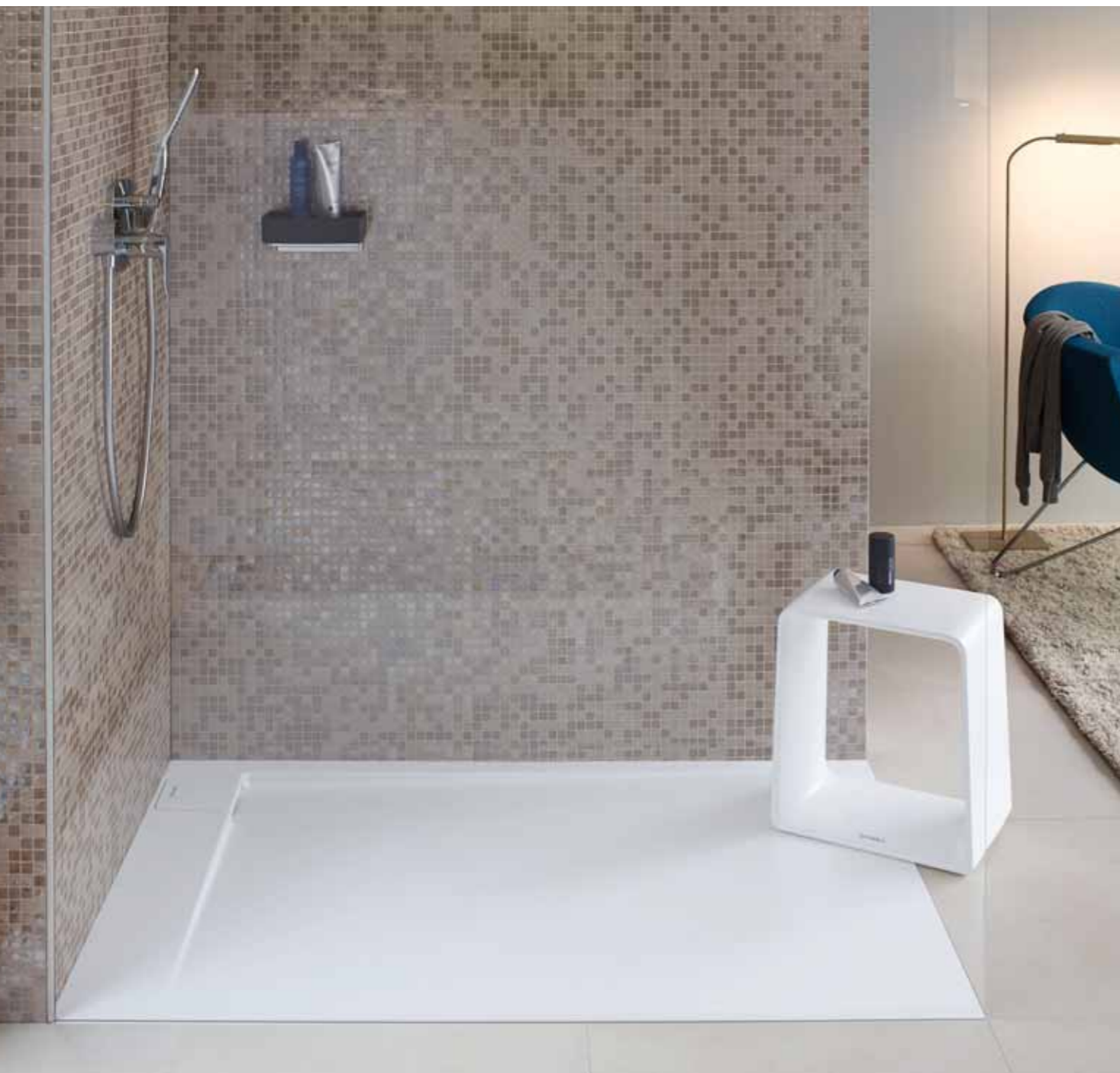

The P3 Comforts shower tray made of the innovative slip-resistant DuraSolid® can be flush-mounted, semi-recessed or surface-mounted. The broad edge area also serves as a convenient shelf space. The outlet cover can be removed for easier cleaning. The surface has been designed to guarantee a high drainage rate. An optional shower seat offers even greater comfort – and naturally it can also

be used anywhere in the bathroom. The shower tray can be combined with the OpenSpace and OpenSpace B shower enclosures from Duravit and any standard shower partitions. With the new DuraSolid® material (slip-resistance class B), P3 Comforts not only offers pleasure, but also safety as standard.



90x90 cm, 100x100 cm and 120x120 cm



P3 Comforts shower trays are available in sizes: 90 x 80 cm, 100 x 80 cm, 100 x 90 cm, 120 x 80 cm, 120 x 90 cm, 120 x 100 cm, 140 x 90 cm, 140 x 100 cm and 160 x 100 cm



Stool 35/38 cm wide and 42 cm high

P3 Comforts

Design by Phoenix Design



Starck Slimline

Design by Philippe Starck



Square is available in three sizes
80x80 cm, 90x90 cm and 100x100 cm



Rectangle	90x75 cm
140x70 cm	140x75 cm
150x70 cm	150x75 cm
160x70 cm	160x75 cm
	170x75 cm
90x80 cm	
100x80 cm	100x90 cm
120x80 cm	120x90 cm
130x80 cm	130x90 cm
140x80 cm	140x90 cm
150x80 cm	160x90 cm
160x80 cm	160x90 cm
170x80 cm	170x90 cm
180x80 cm	180x90 cm

120x100 cm

Duraplan

Design by Prof. Frank Huster



80x80 cm, 90x90 cm, 100x100 cm
and 120x120 cm



100x80 or 90 cm, 120x80 or 90 and 100 cm, 140x90 cm and
160x90 cm



Minimal rim height

In the Starck Slimline shower tray, the rim height has been reduced to 20 mm and thus appears not only flatter but also more elegant and lightweight. It is available in sizes 80x80 cm to 180x90 cm, as well as in four different forms – for showering comfortably in pairs, as well as alone.

The Starck shower trays are optionally available with the special, transparent Antislip coating to keep things on a firm footing.



No height, no problem

The Duraplan flush-mounted shower tray: Thanks to a height-adjustable frame, it is possible to create a perfectly-suited space for the tray, while the outlet can be positioned precisely by means of a template. An innovative drain system that can be visually checked for leaks prevents any problems and water damage. And should it be necessary, the shower tray can be removed to allow easy access to the drainage system.

Option: The shower trays are available with the special, transparent, Antislip coating.



Slip-resistant Antislip coating



Duraplan shower tray in combination with OpenSpace

Flush-mounted shower trays are popular with design-oriented bathroom users but, until now, were always regarded as something of a challenge. The DuraPlan flush-mounted shower tray offers a solution: Particularly suitable for minimal installation heights, it is installed after the tiles have been laid; this prevents any problems that can occur when shower trays are installed too soon. The OpenSpace and OpenSpace B shower enclosures perfectly complement DuraPlan.



OpenSpace

Design by E00S

OpenSpace is the shower enclosure that enlarges the bathroom. This effect is achieved through an innovative functional principle: Profiles made of high-gloss polished aluminum form the frame – only on the wall and without jutting into the room.

After showering, the glass doors can simply be “folded” back against the wall. Thanks to a lifting-and-lowering mechanism, they move smoothly and are tightly sealed.

The door on the shower fittings side is optionally available with mirrored glass, which further enhances the sense of space. Shower fittings and hose are concealed; the bathroom looks tidy and appears larger. Available in five sizes and a total of 20 variants, OpenSpace is ideal for combining with the flush-mounted DuraPlan, P3 Comforts and Stonetto shower trays, as well as with other shower trays and floor tiles, to create a high quality shower solution. The OpenSpace accessories promise even more showering comfort.

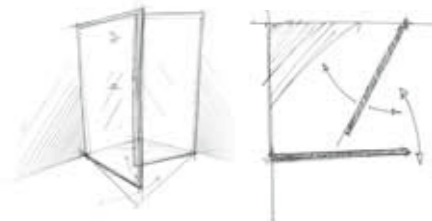

The swiveling OpenSpace and OpenSpace B shower enclosures can be used to create not only the impression of space, but actual usable space. Ingenious: the polished aluminum frames conceal a special profile that enables a high level of adjustment and fine-tuning.

OpenSpace B

With OpenSpace B, Duravit takes the successful concept to a new level: the good value for money is based on the simpler design of the wall profiles. Positioned on both sides with slim chrome-look frames and glossy white inserts, these profiles define the contour and ensure stability. The functions are the same as those in OpenSpace. A lifting-and-lowering mechanism, as in OpenSpace, ensures that the screen is

easy to manage. The doors with a continuous handle have magnetic strips to facilitate closing. OpenSpace B is available in four sizes and a total of 16 variants and is ideal for combining with the DuraPlan, P3 Comforts and Stonetto flush-mounted shower trays, to name just a few. Alternatively, it can also be installed directly on the tiled floor. No measuring service is necessary.



Shower basket



Handle with shower basket



Shower seat

OpenSpace Accessoires

The ideal accessories for the shower. There are two baskets to choose from. The handle (center) offers safety while simultaneously doubling as support for the practical shower basket. When folded back against the wall, the comfortable shower seat (below) disappears behind the closed glass door of OpenSpace and OpenSpace B.



Angled shower arm, rectangular rosette 35.2 cm
UV0670 0310 00



Shower arm ceiling fixture, round rosette
12.5 cm # UV0670 0220 00,
22.5 cm # UV0670 0230 00,
32.5 cm # UV0670 0240 00



Fantastic shower experience. The showerheads can also be combined with all tap-fitting ranges and harmonize perfectly with the typical Duravit style. Available in a round and rectangular design, each in different sizes, they promise a special shower experience.



Showers



See the big picture for a harmonious design. Because Duravit sees the big picture when it comes to bathrooms, we also design our products to be combined with one another. For example, our tap-fitting ranges are perfectly complemented by matching hand showers and showerheads with various corresponding accessories. This makes it that much easier for the bathroom professional and user to plan a harmonious bathroom.



Complete system

Our showerheads are a practical all-in-one solution for enjoyable showering and are also suitable as a renovation solution without requiring complex in-wall work. With showerhead (24 cm), hand shower (12 cm) and optional thermostat or single-lever showerhead mixer.



ø 14 cm, 3 spray modes with air function
UV0650 0120 00



ø 12 cm, 3 spray modes with air function
UV0650 0110 00



ø 10.5 cm, 1 spray mode with air function
UV0650 0100 00



ø 10.6 cm, 3 spray modes
UV0650 0090 00



ø 9.7 cm, 1 spray mode
UV0650 0080 00

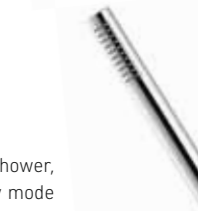

Hand shower, 1 spray mode
UV0640 0000 00

With a design that matches all Duravit tap-fitting lines, the hand showers also offer a high level of functionality.

Inipi

Design by E00S



Thanks to an ingenious layout, the compact cabin, with a width of just 180 cm, offers the user a comfortable amount of space. The sense of space is further enhanced by a large glass front that creates a light, airy atmosphere, by the clear aesthetics and the indirect lighting of the rear wall. The sitting and lying areas, as well as the floor,

wall and ceiling covering, are made of natural wood. The feeling of calm, clarity and relaxation is supported by the LED coloured light, the integrated loudspeaker with radio, and the AUX connection together with pre-programmed light-sound-climate scenarios.

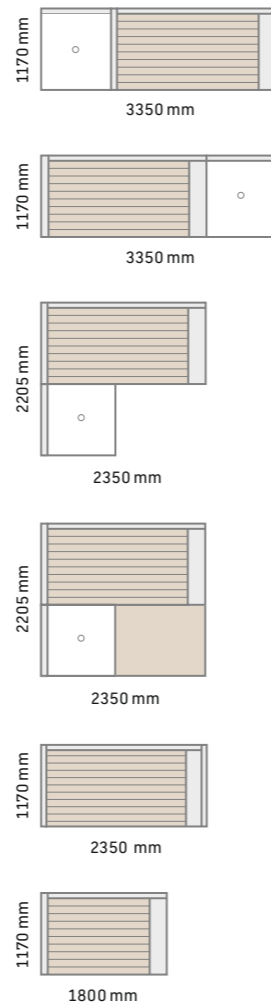

Fully-fledged sauna in a small amount of space. Tidy design from E00S, both inside and out. Smart operating elements such as a wooden button to control the water poured over the hot coals, timer, ECO mode, and an excellent temperature profile.

Inipi B

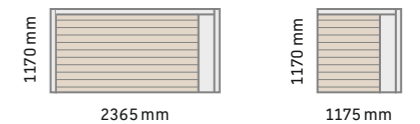

110 °C
—
95 °C
85 °C
—
75 °C
60 °C
—
35 °C



The heater has been optimized to enable a temperature of up to 110°C below the ceiling. In the upper lying area, the temperature is approx. 75°C and, below the lower sitting and lying area, approx. 60°C.

Enjoy sweating whilst sitting in comfort

Inipi B comes in two sizes: the larger variant offers two people space to lie down in the sauna in comfort. The Inipi B Super Compact variant for one person has a footprint of approx. 117.5x117 cm and fits in just about any corner. Nevertheless, the small version is also large enough for the user to change position during the sauna session, thereby ensuring a comfortable and ergonomic sitting posture, even over longer periods. The backrest with horizontal wooden louvres is individually adjustable and backlit with a soft LED light. The door and side section made of transparent safety glass create a feeling of space.



Perfection doesn't just happen of its own accord. The sum of craftsmanship, state-of-the-art production and smart processes form the basis. The experience and expertise of the employees additionally facilitate innovation and set us apart.

Craftsmanship

The magic is always in the details.

Although Schenkenzell is only a few kilometres from Hornberg in the Black Forest, the two factories are worlds apart. While Hornberg has been home to the manufacture of the finest bathroom ceramics from clay, kaolin, quartz and feldspar since 1817, the Schenkenzell facility specializes in the construction of bathroom furniture and materials such as wood, metal and high-quality lacquers. Bathroom furniture has been manufactured here since 1978, combining high standards of craftsmanship and the latest industrial production techniques. Around 170 employees manufacture vanity units, cabinets, shelves and consoles, the design and quality of which

comply fully with our requirements and those of our customers. The advantages of having our own production facilities are obvious: only in our own furniture factory can we guarantee the design, manufacture and quality of bathroom furniture in line with Duravit standards. They are developed in tandem, which means that: bathroom furniture and ceramics from Duravit complement each other and are perfectly harmonized. And while our furniture is manufactured in serial, industrial processes, we are happy to tailor it exactly to our customers' wishes and bathroom dimensions. Bathroom furniture by Duravit can therefore be as unique as hand-made furniture.

- 182 **Sustainable bathroom furniture**
- 185 **c-bonded**
- 186 **Universal consoles**
- 190 **Light and mirror**
- 192 **Sustainability**



However, at the same time it complies with industrial standards in a manner only possible by a premium serial product. Our bathroom furniture is manufactured specifically for use in this application area and is therefore resistant to splashwater and increased humidity. Finishes are painstakingly sealed and made water-resistant, and their edges waterproofed in a PVC-free process. At least as important: Our bathroom furniture can be flexibly combined. And because it was developed by one brand, it is optimized for living bathrooms right down to the smallest detail. Aspiring to the perfectly appointed room, we use a range

of real wood veneers complemented by a range of lacquer and décor finishes. In total our customers can choose from over 46 finishes in seven series-based furniture programmes and six cross-series programmes. Together with Duravit ceramics, this gives the bathroom an individual and at the same time uniform design with products that all meet the same high quality standards – the very highest. Sustainability in the selection of raw materials and production processes is our top priority, for example recovering scrap wood in the heating system or using paints and lacquers with the “Blue Angel” mark.

- 01 The panels are kept in the fully-automatic store until they are required for processing
- 02 Craftsmanship is what's needed to get the details right
- 03 Quality control with a keen eye and sense of finesse
- 04 The wooden edges are given one last polish during the fine-tuning process
- 05 Sourced from natural materials, every piece of wood used is an absolute one-off

- 06 Our melamine coating makes furniture highly scratch-resistant
- 07 Precision work: joining the washbasin to the vanity unit
- 08 Mirrors: connections and frames are pre-fitted
- 09 Manual assembly of hinges, drawers and furniture fittings
- 10 Finished individual items are stored and configured via a fully automatic process

Comfortable operation, perfect order

With the new tip-on technology, the drawers open with a tap. A new organizer system creates order inside. This is available in either Maple or Solid Walnut. A gentle push is all it takes and the drawers close automatically. Everything is perfectly organized and tidy.



An example of design and the craftsman's precision

The material thickness of the washbasin is hidden from view by the innovative c-bonded technology. It is reduced to a precise rim that, at the transition between the cool, smooth ceramic and the natural structure of the wood, feels unusually pleasant to the touch.

c-bonded



Organizer system

Everything in its place.

Darling New and Vero Air washbasins, combined with the L-Cube vanity unit, become a minimalist masterpiece thanks to the patented c-bonded technology from Duravit. Precise and finished to the millimetre, the furniture begins exactly where the ceramic ends. The materials form a perfect unit.



Storage to suit any requirement: a pull-out compartment, two drawers or floor-standing with the added space.

Universal consoles

One range – seven different design styles.



Perfectly organized and everything in its place. The organizer systems are available with the L-Cube, Vero, Happy D.2, DuraStyle, Ketho and X-Large series - optionally in solid American Walnut or Maple.

The interior and finish need to be ordered at the same time because the organizer systems are perfectly harmonized with the respective bathroom furniture.



Optionally 3 or 4.5 cm



The console panels come in two heights (3 or 4.5 cm) and two depths (55 cm or Compact in 48 cm) as well as the individual widths 80 to 200 cm. With one or two vanity units 60 to 100 cm wide and also low cabinets of 30 to 80 cm width. Alternatively with a pull-out compartment or two drawers.



DuraStyle

Design by Matteo Thun

There are two distinct variants of the DuraStyle complete bathroom range: for private bathrooms and for the project sector. The bathroom furniture is dominated by visual lightness, achieved through a mix of open and closed surfaces and furniture accessories made from real wood.

Happy D.2

Design by sieger design

Elegance is timeless. Fine radii lend the Happy D.2 complete programme an unmistakable archetypical formal language and elegant chic. The Happy D.2 bathroom furniture impresses with its intriguing details such as the easy-care surface with a "linen" texture.

Ketho

Design by Christian Werner

The Ketho bathroom furniture range is characterized by clear forms, well thought-out practical features and outstanding value for money. The distinctive, ergonomic handles feature throughout the range.

L-Cube

Design by Christian Werner

Bathroom furniture as a collage. The elegant, rectangular furniture fronts are handle-free and are gently opened and closed by tip-on technology. A clear shadow gap is a characteristic feature of the bathroom furniture.

Vero

Design by Kurt Merki Jr.

The stark contrast between the horizontal grain of the veneer and the characteristic vertical handle is an integral part of Vero's design. The complete programme impresses with a consistently rectangular look, a comprehensive selection and a wide range of design options.

X-Large

Design by sieger design

The name says it all! X-Large bathroom furniture offers plenty of storage space in an ultra-elegant look for bathrooms large and small. Various widths and two depths offer maximum flexibility, numerous finishes including real wood veneers and lacquer for maximum individuality.



Mirror cabinets – The mirror cabinets can be combined with all Duravit series due to their pared-down and timeless aesthetic design language. Available in widths of 61, 81, 101 and 121 cm and in three design variants, including built-in versions. All models have a 6 cm-wide LED light band with a light output of over 300 lux, a pleasant light colour of 4000 kelvin and more than 30,000 hours of operation.



Built-in mirror cabinet Mirror cabinet

The interior of the mirror cabinet offers plenty of practical storage. The doors are also mirrored on the inside. The LED light band provides excellent illumination and a pleasant atmosphere.

With over 300 lux the light band perfectly illuminates the field of vision.

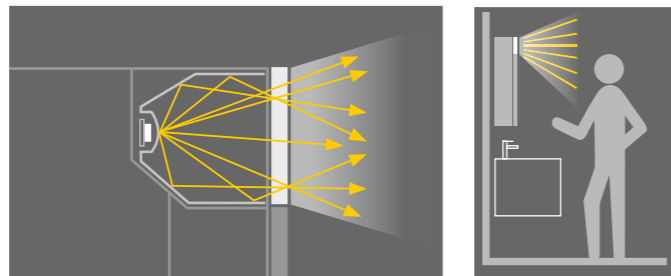

Mirror – Of all the elements in a bathroom, the mirror is probably the one that gets looked at the most. That being so, our options for edging light at the side or top or indirect ambient light show the mirror in its best light, upgrading it to an attractive design element in both private and commercial bathrooms. Light output of over 300 lux, a pleasant light colour of 4,000 kelvin.



Edging light at the top Edging light at the sides Ambient light

Light and mirror

Perfectly presented, optimally illuminated and intelligently stowed.

The variant with ambient light gives out pleasant, indirect light from all four sides, and the wallwash effect creates an extraordinary, atmospheric lighting effect within the room. Because this variant does not directly illuminate the viewer, additional bathroom lighting such as downlights is required. Mirror heating ensures that the surface of the mirror does not steam up. Available in the widths 40 (only with edging light at the top), 60, 80, 100 and 120 cm.



In the "Best" design variant, the LED washing-area light directly illuminates the area below the mirror carcass.



The switch/socket unit is within the carcass. In the "Better" design variant, this is finished in diamond black. May also be built-in using the installation set.



The mirrored rear wall offers further mirrored surface when the door is open. Here, too, the switch/socket unit is within the carcass. Available in the "Best" design variant.



The lighting works with a sensor switch, enabling it to be turned on and off with a simple motion of the hand. Available in the "Better" and "Best" design variants.



The integrated heating prevents the surface of the mirror from steaming up. This is the "Best" version of the ambient light model.



The LED washbasin lighting creates a pleasant light directly on the washbasin and is available for all mirror models in the "Best" design variant.

A lot of people talk about sustainability. We do something about it. And we manufacture exemplary ecological products that do their bit toward sustainable building and living.

Sustainability



Duravit is a member of the German Society for Sustainable Building, DGNB. The purpose of the DGNB system is to objectively describe and evaluate the sustainability of buildings and districts. Quality in the broadest sense, across the entire building life cycle, is evaluated.



Duravit is a member of USGBC (U.S. Green Building Council), a committee that advocates efficient and energy-saving buildings for a sustainable future. One of its measures is the LEED program for green construction. LEED-certified buildings are efficient, have a positive effect on residents' health and promote renewable energies.



Duravit is a member of Institut Bauen und Umwelt (IBU), an initiative by building product manufacturers promoting greater sustainability in the construction industry. IBU offers a self-contained external representation of environmental product declarations (EPDs) of Ecolabel Type III in accordance with ISO and CEN standards.



The IBU has awarded Duravit the Environmental Product Declarations (EPD) for the product groups sanitary ceramics and sanitary acrylic. An EPD demonstrates the environmental qualities of a product as well as the company's sense of responsibility in terms of sustainable construction.



The European Water Label is a voluntary system by European bathroom manufacturers in which Duravit participates. The online database of the European Water Label and marks that can be affixed to products create transparency by presenting the water-consumption values of bathroom products in an easily understandable manner.



Duravit is a member of WaterSense, a partnership program of the U.S. Environmental Protection Agency (EPA). It is mainly aimed at consumers who want to reduce their water consumption. To be awarded the label, products and services must save at least 20% without impairing function and performance.



Duravit bathroom furniture production has the PEFC seal of quality. PEFC is the largest institution ensuring sustainable forestry through an independent certification system. Wood and wood products with the PEFC seal come from forests with proven ecological, economical and sustainable management.



Duravit has been certified in compliance with ISO 9001 (quality management), ISO 14001 (environmental management) and ISO 50001 (energy management). All management processes are subject to an ongoing improvement process and satisfy internationally recognized requirements.



Discover our colours, feel the surfaces, develop your very own bathroom ideas!

Colours and surface finishes

Sanitaryware colours



00 White



08 Black

Not everything is always black or white. Well, our Vero series is. But it really suits it.



00 White



21 Sand Satin Matt



23 Grey Satin Matt



26 White Satin Matt

The Luv basins also feature silk matt nuances such as White, Sand and Grey. The surfaces of the Duravit furniture series are so varied and unique that you need to see and feel them for yourselves. And that's precisely what you can do in this last chapter.

DuraSolid®

Cape Cod (bathtubs)

Luv (bathtubs)

P3 Comforts

Shower + Bath (shower trays)

Stonetto (18, 38, 48, 68)



00 White



18 Concrete
Stonetto



38 White
Stonetto



48 Sand
Stonetto



68 Anthracite
Stonetto