

Beslag



Norwich Cathedral Visitors Centre and Refectory, Norwich, UK

Indhold

Beslag	5	Dørgreb forlænger	80
Referencer	7	Dørgrebspindel 7x7mm og 8x8mm	82
SKG Produkt certifikat	9	Dørgrebspindel t/fast montering m/hank	83
Certificates for SKG narrow / long plate and cylinder rose	10	Dørgrebspindel 9x9mm	84
Godkendt af Holzforchung Austria	10	Delt dørgrebspindel	84
Mål	12	Envejs dørgrebspindel	86
Dørgreb L form 14mm	14	Ensidig dørgrebspindel	86
Dørgreb U form 14mm	16	Ensidig dørgrebspindel t/låsekasse m/delt grebsfunktion	86
Dørgreb Coupe	18	Værktøj	88
Dørgreb L form 16mm	20	Boreværktøjer	90
Dørgreb U form 16mm	22	Skruer	92
Dørgreb C form 16mm	24	Returfjedre og styrebrikker	94
Dørgreb U2 form 16mm	26	Rosetter m/kugleleje	96
Dørgreb M form 16mm	28	Rosetter t/fast dørgreb/knopper	98
Dørgreb LF form 16mm	30	Nøgle- og blindskilte	100
Dørgreb UF form 16mm	32	Oval 30x65mm nøgle- og blindskilte	102
Dørgreb LF form 16mm	34	Ø50mm cylinderringe t/oval cylinder ASSA	104
Dørgreb UF form 16mm	36	Ø50mm cylinderringe PZ	106
Dørgreb L form 19mm	38	Ø50mm cylinderringe UNION	108
Dørgreb U form 19mm	40	Ø50mm cylinderringe KESO/KABA	110
Dørgreb C form 19mm	42	Cylinderringe	112
Dørgreb U2 form 19mm	44	Ø54mm cylinderringe PZ	114
Dørgreb C2 form 19mm	46	Oval 30x65mm cylinderringe PZ	116
Dørgreb M form 19mm	48	Oval 30x65mm cylinderringe ASSA	118
Dørgreb LF form 19mm	50	Oval 30x65mm cylinderringe KESO/KABA	120
Dørgreb UF form 19mm	52	Vridergreb	122
Dørgreb LF form 19mm	54	Ø50mm vridergreb – handicap	124
Dørgreb UF form 19mm	56	Nøddgangsbesætning	126
Dørgreb B form 19mm	58	Ø50mm toiletbesætninger	128
Dørgreb FF form 19mm	60	Ø50mm toiletbesætninger – handicap	130
Dørgreb FFG form 19mm	62	Udenpåliggende toiletbesætninger	132
Dørgreb FFU form 19mm	64	Toiletbesætning i skydedørsskål	134
Dørgreb O form 19mm	66	Skydedørsskål rund	136
Dørgreb L form 22mm	68	Skydedørsskål oval	138
Dørgreb U form 22mm	70		
Dørgreb FK form forsat knop	72		
Dørgreb CK form cylindrisk knop	74		
Dørgreb KK form rund knop	76		
Ø130mm knop	78		

Langskilte MATRIX SKA standard	139	Langskilte MATRIX DIN standard	179
210x60x2mm		210x60x2mm, 210x42x2mm and 170x60x2mm	
Blind	142	Blind	182
M/dørgrebshul	144	M/dørgrebshul	184
Ovalcylinder	146	PZ cylinderhul	186
Ø40mm hul	148	Keso/kaba cylinderhul	188
Vridergreb	150	Toilet vridergreb	190
Vridergreb – handicap	152	Toilet vridergreb – handicap	192
Toiletbesætning	154	Toiletmarkering	194
		Nøglehul	196
210x30x3mm		210x30x2mm	
Blind	156	M/dørgrebshul	198
M/dørgrebshul	158	PZ cylinderhul	200
Ovalcylinder	160	Vridergreb	202
Rokoko cylinder	162	Toiletmarkering	204
Vridergreb	164		
175x175x2mm		175x175x2mm	
Blind	166	M/dørgrebshul	206
M/dørgrebshul til oval cylinder	168	PZ cylinderhul	208
Ø40mm hul	172	Toilet vridergreb	210
Vridergreb	174	Toilet vridergreb – handicap	212
Vridergreb – handicap	176	Toiletmarkering	214
Toiletbesætning	178	Nøglehul	216

Ringetryk	218	Vægdørstopper	286
		Gulvdørstopper	288
Kvadratiske piktogrammer 175x175mm	220	Vinduesgreb L form 14mm	290
Piktogrammer	222	Vinduesgreb U form 14mm	292
Futura heavy husnumre og bogstaver	224	Vinduesgreb L form 16mm	294
		Vinduesgreb U form 16mm	296
Møbelhank lige Ø10mm	226	Vinduesgreb L form forkrøppet 16mm	298
Møbelknop	228	Vinduesgreb C form 16mm	300
Møbelhank	230	Vinduesgreb M form 16mm	302
PZ Cylinder dørhank	232	Vinduesgreb FF form 16mm	304
Dørhanke lige Ø14mm	234	Vinduesgreb T form 16mm	306
Dørhanke forkrøppet Ø14mm	236	Vinduesgreb L form 16mm KLIKSTOP	308
Dørhanke lige Ø19mm	238	Vinduesgreb U form 16mm KLIKSTOP	310
Vertikal/horizontal dørhank m/grisetrynebolt	240	Vinduesgreb M form 16mm KLIKSTOP	312
Dørhanke forkrøppet Ø19mm	242	Vinduesgreb C form 16mm KLIKSTOP	314
Dørhanke lige Ø25mm	244	Vinduesgreb FF form 16mm KLIKSTOP	316
Vertikal/horizontal dørhank m/grisetrynebolt	246	Vinduesgreb FFG form 16mm KLIKSTOP	318
Dørhanke forkrøppet Ø25mm	248	Firkantstift og reduktionsbøsninger til vinduesgreb	320
Dørhanke lige Ø32mm	250		
Dørhanke forkrøppet Ø32mm	252	Gelænderholdere	322
Dørhanke lige FF Ø14 mm	254	Kroge	324
Dørhanke lige FF Ø19 mm	256		
Dørhanke lige FF Ø25 mm	258		
Dørhanke lige FF Ø32 mm	260		
Dørhanke Ø20mm	262		
Dørhanke Ø32mm	264		
Dørhanke Ø38mm	266		
Cirkelhank	268		
Dørhanke på skilt Ø14mm	270		
Dørhanke på skilt Ø19mm	272		
Albuehanke Ø16 mm	274		
Tilbehør til hanke	280		
Tilbehør til hanke	282		
Tilbehør til hanke	284		

Beslag



The Royal Danish Playhouse, Copenhagen

Lokalet

Når du træder ind i et lokale er dørgrebet det første objekt du rører. Hvis objektet er ru, har en aparte eller uventet facon, er det sikkert det vil farve brugerens tolkning af lokalets visuelle kvaliteter.

Omvendt, bør et produkts fremtoning gøre tanken om at røre det tiltrækkende – dog uden at tiltrække så meget opmærksomhed, at produktet begynder at trække brugerens øje efter en måned eller to, hvilket er grunden til d line dørgreb, hanke osv. altid er udviklet som en konstant balancegang mellem forskellige fornemmelser – nemlig dem fremkaldt af syn, lyd og berøring.

d line er et enkelt og funktionelt design, men det minimalistiske ydre gemmer avanceret teknik, der sikrer produkternes styrke og holdbarhed i mange år fremover.

Produkterne

Produkterne i d lines beslagserie kan bruges i alle områder af bygningen og er velegnede til høj trafikale områder, såsom kommercielle eller offentlige bygninger, grundet den unikke kugleleje mekanisme og styrke i alle d line greb samt det varierede udvalg af produkter der er tilpasset til serien.

d line beslagserien er en komplet serie af beslagprodukter - lige fra dørgreb, dørskilte, hanke, vinduesgreb og dørstop. Styrke, holdbarhed og funktionalisme spiller en integreret rolle i vores produktudvikling, og i den overordnede form og karakter af produkterne. Vi udvikler og producerer vore produkter i overensstemmelse med de højeste tekniske standarder, en stram designlinie og via en vedholdende dedikation til tekniske fremskridt vil disse kvaliteter fortsætte med at hæve niveauet og dermed også d line serien til et niveau af tidløshed.



Boutique GUBI, Copenhagen

Materialet

Alle d line produkter er fremstillet i marine kvalitet rustfrit stål, hvilket gør vores produkter egnet til anvendelse i høj luftfugtighed eller klimatisk udfordrende områder. Den eneste stål der anvendes til vores produkter er derfor AISI 316, også kendt som marine rustfrit stål. AISI 316 er en af de stærkeste og mest elastiske legeringer på markedet i dag.

Rengøring, pleje og vedligeholdelse

Rustfrit stål er let at rengøre. Det er typisk tilstrækkeligt at rengøre med sæbe eller et mildt vaskemiddel og varmt vand og skylle efter med rent vand. Et forbedret resultat opnås, hvis den rensede overflade tørres efter med en klud. Specifikke metoder til rensning kan forekomme og i så fald vil de rette instruktioner blive givet.

Design der holder

Set fra et designmæssigt synspunkt forsøger d line for at gøre det simpelt! d line beslag er udemærket i stand til at stå alene med det enkle, klassiske design, hvor linerne ser ud til at være et par år gamle, men tværtimod blev tegnet for næsten 40 år siden.

Hos d line sikrer vi, at vores produkter lever op til de højeste krav i kvalitet, funktionalitet og enkelthed, så vi til enhver tid kan supplere ethvert andet produkt, der anvendes i rummet.

Som sagt af d lines chefdesigner Knud Holscher:

"Enkelt isenkram er for arkitektur, hvad knapper er for en skjorte, begge dele skal støtte udformningen og ikke distrahere fra det samlede udtryk."

Hos d line er vi stolte af at tilbyde så bredt et udvalg af, ikke kun beslag, men badværelses- og sanitetsprodukter af samme høje d line design kvalitet - produkter, der sikrer, at det miljø hvori de er installeret, lever op til morgendagens krav.



Referencer



The Bank

Ejer: Kroonenberg Group
Entreprenør: Midreth BV
Arkitekt: Rijnboutt Architecten
Kunde: Internat Mijdrech i Holland

The Bank blev bygget mellem 1926 og 1932 og var den første ABN Bank i Amsterdam. Udformningen er et typisk eksempel på solid elegance og var i hænderne på arkitekterne BJ og WB Ouëndag, samt grundlægger af Amsterdam School of Architecture, HP Berlage.

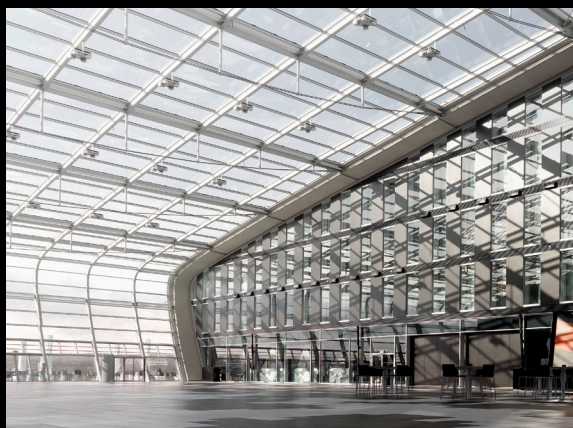

The Kameha Grand Bonn

Arkitekt: Karl-Heinz Schommer
Interiør: Marcel Wanders
Størrelse: 19.000 kvm
Kunde: Lifestyle Hospitality & Entertainment Group i Tyskland

Kameha Grand Bonn åbnede i efteråret 2009, har 254 værelser, inklusive 62 suiteer og en fleksibel konference-cum-balsal, der kan rumme op til 2.500 gæster. Kameha Grand Bonn har vundet den prestigefyldte MIPIM-pris, og den internationale Real Estate Industry-pris. Hotellet imponerede messebesøgende og juryen i kategorien "Hotels and Touristic Resorts."



Bella Sky Comwell Copenhagen

Ejer og udvikler: Bella Center
Arkitekt: 3XN
Gulvareal: 42.000 kvm (814 værelser / 23 etager)
Land: Danmark

Bella Sky Comwell er et firestjernet konferencehotel, der støder op til Bella Center Copenhagen i Ørestaden. Med 814 værelser, er Bella Sky det største hotel i Skandinavien. Bestående af to asymmetriske tårne, afhænger hotellets form af udsigtspunktet. Tårnene er kendetegnet ved en dynamisk og grafisk overflade af trekantede paneler, og endda fra en stor afstand, er den lidt pixelagtige effekt synlig. Lobbyen flettes ind i indgangen til Bella Center og „drejer“ stueetagen, hvilket giver hotellet en dramatisk tilstedeværelse i det omkringliggende miljø.



Certifikater

SKG Product certificate
448 . 630 . 04

Certificate holder:
 d line as
 Røholmsvej 12F
 DK-2620 Albertslund (DK)

T: 0045 72170138
 F: 0045 72170139
 E: info@dline.com
 I: www.dline.com

date of issue: 28-nov-2011
replace version:
date of expire: 28-nov-2016

SKG

Büro/Hauptschreiber
 Nieuwe Kanaal 9F
 Wageningen
 Postadres
 Postbus 362
 6700 AJ WAGENINGEN

T 0317 - 421 720
 F 0317 - 421 677
 E info@skg.nl
 I www.skg.nl

Declaration of SKG:

SKG declares that Lever handles and knob furniture, produced by or on behalf of the certificate owner.
 Delivered under type- and / or article number:
 Ø14: model L, U
 Ø16: model L, U, U2, M, UF, LF, C, C2
 Ø19: model L, U, U2, M, UF, LF, C, C2, B, FF, FFG, O

with the following technical specification:
 Stainless steel lever handles on aluminum roses, solid roses or back plates- Unsprung

Meets the classification according **EN 1906 : 2010**

Digit	1	2	3	4	5	6	7	8
grade	4	7	-	0	1	4	0	U
	Category of use	Durability	Door mass	Suitability for use on fire / smoke doors	Safety	Corrosion resistance	Security	Type of operation

as determined by SKG and reported in test report **SKG 11-401**

Wageningen, 28-nov-2011

 ir. Harm A.J. van Dantel
 certificate manager

This certificate is in accordance with the SKG Regulations approval, product certification and process certification: 2011.

VALIDITY OF THIS PRODUCT CERTIFICATE
 This product certificate is valid as long as all the obligations bound therewith are met and in so far as the period of validity has, for whatever reason, not been terminated at an earlier date.
 Validity is cancelled in any case when:
 1. the certificate is reported as discontinued;
 2. the certificate is discontinued by one of the parties;
 3. the certificate is issued on a non-current date;
 4. the expiry date mentioned on the front page is reached.
 Names of the Product Certificate are withheld to inform from SKG as to whether this document is still valid.

digit	1	2	3	4	5	6	7	8
grade	4	7	-	0	1	4	0	U
	Category of use	Durability	Door mass	Suitability for use on fire / smoke doors	Safety	Corrosion resistance	Security	Type of operation

SKG Produkt certifikat

d lines særpræg er baseret på en overbevisning om at design skal være minimalistisk og effektiv – et princip, der realiseres gennem form, styrke og funktion. Over en periode på fire årtier er d line serien blevet belønnet med mange internationale design priser. Kvalitetsniveauet af vores produkter er næsten en standard, men for at overholde de strengeste europæiske kvalitetskrav er innovation af vores produkter en nødvendighed.

En nylig test foretaget af SKG, et uafhængigt hollandsk anerkendt testinstitut, har vist at alle d line dørgreb har overlegen styrke og resulterede dermed i en EN 1906 godkendelse med højeste karakter 4, i kategorien brug.

Godkendt af Holzforschung Austria



Vi er stolte af at kunne meddele, at d line er blevet godkendt af Holzforschung Austria, et akkrediteret forskningsinstitut, test og inspektionsorgan for Austrian Society for Wood Research (ÖGH).

Åbningsretning

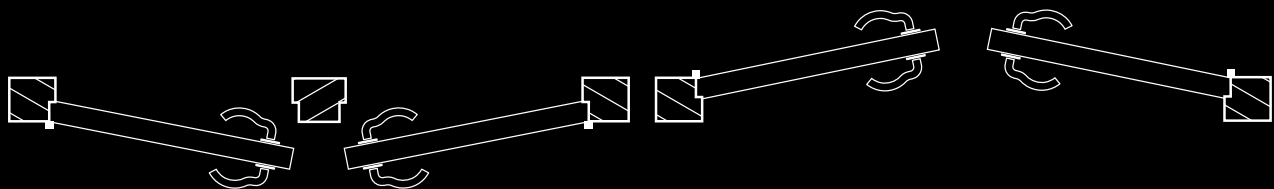
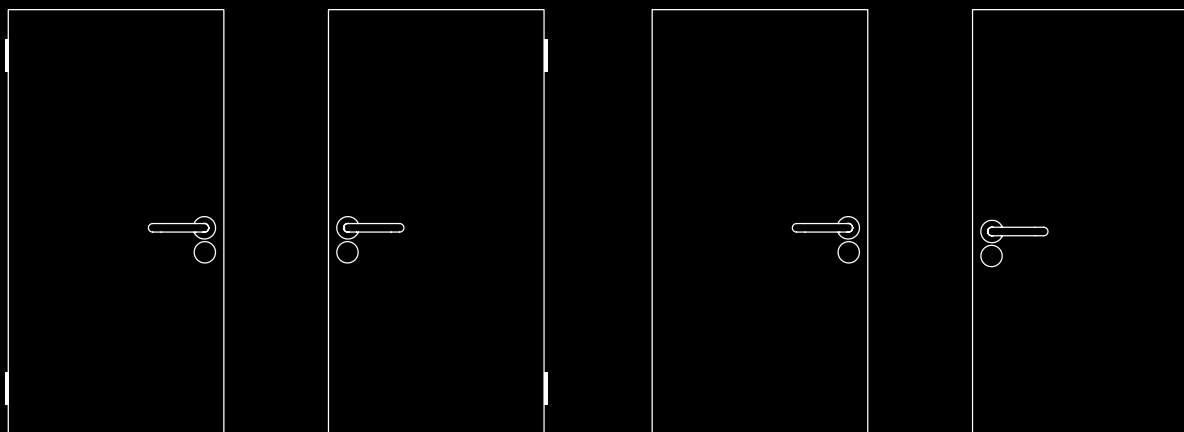

Venstre hånd
åbner udad

Højre hånd
åbner indad

Venstre hånd
åbner indad

Højre hånd
åbner udad

Mål

Vær opmærksom på låsekassens placering samt A og B mål ved bestilling af cylinderringe og vridergreb

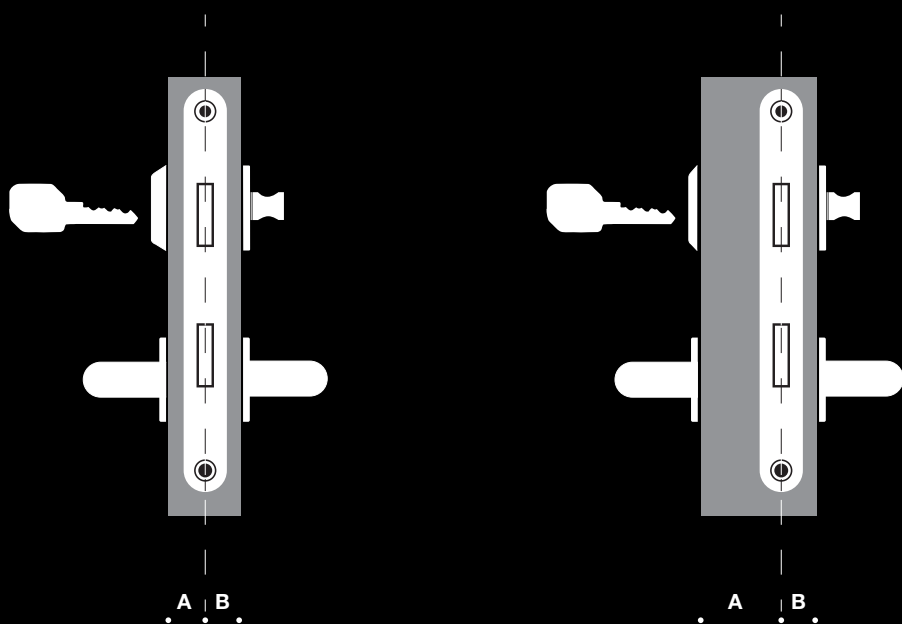
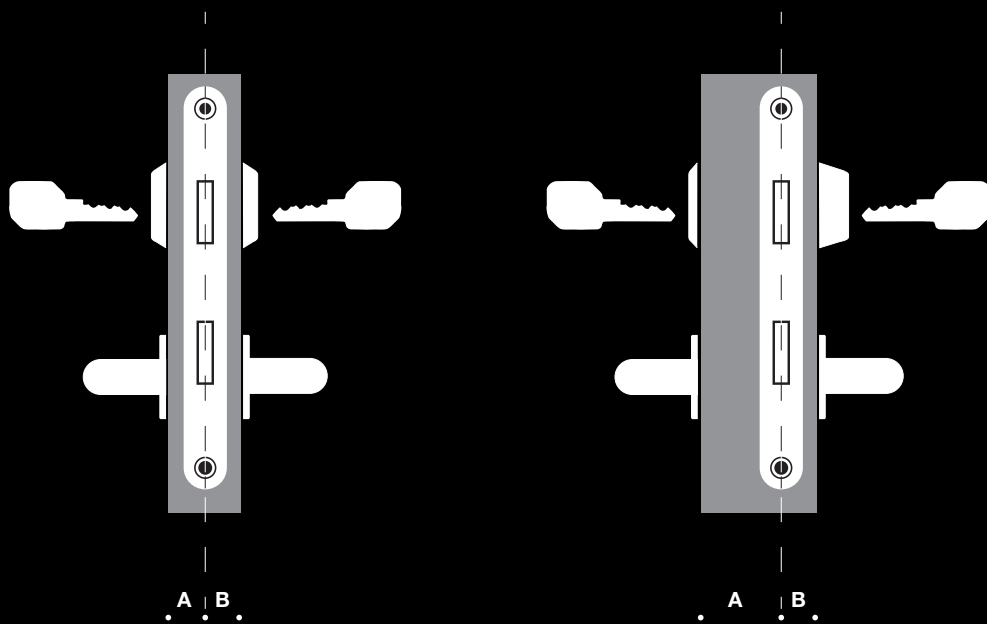

Dørgreb L form 14mm



Dørgreb L form 14mm

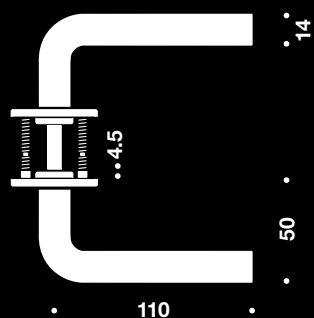

Beskrivelse

Sæt 7x7mm, m/klipsroset cc 30/38mm, 33-59mm

Sæt 8x8mm, m/massiv roset cc 30mm, 33-59mm

Sæt 8x8mm, m/massiv roset cc 30mm, 59-85mm

Sæt 8x8mm, m/massiv roset cc 38mm, 33-59mm

Sæt 8x8mm, m/massiv roset cc 38mm, 59-85mm

Sæt 8x8mm, m/klipsroset cc 30/38mm, 33-59mm

Sæt 8x8mm, m/klipsroset cc 30/38mm, 59-85mm

Varenummer

14.0456.02.010

14.0411.02.010

14.0411.02.020

14.0412.02.010

14.0412.02.020

14.0416.02.011

14.0416.02.029

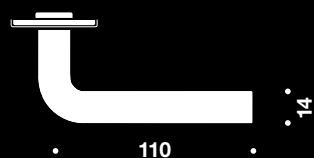

Halvt sæt 7x7mm, m/klipsroset cc 30/38mm

Halvt sæt 8x8mm, m/massiv roset cc 30mm

Halvt sæt 8x8mm, m/massiv roset cc 38mm

Halvt sæt 8x8mm, m/klipsroset cc 30/38mm

14.0456.02.900

14.0411.02.900

14.0412.02.900

14.0416.02.908

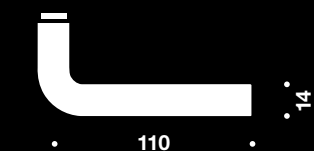

Halvt sæt 7x7mm, u/roset

Halvt sæt 8x8mm, u/roset

14.0450.02.900

14.0410.02.900

Dørgreb U form 14mm



Dørgreb U form 14mm

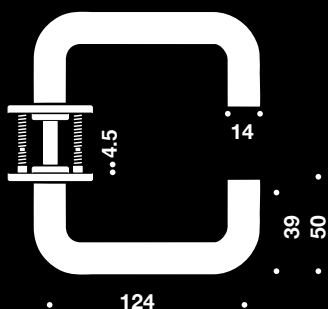

Beskrivelse

Sæt 7x7mm, m/klipsroset cc 30/38mm, 33-59mm

Varenummer

14.0556.02.010

Sæt 8x8mm, m/massiv roset cc 30mm, 33-59mm

14.0511.02.010

Sæt 8x8mm, m/massiv roset cc 30mm, 59-85mm

14.0511.02.020

Sæt 8x8mm, m/massiv roset cc 38mm, 33-59mm

14.0512.02.010

Sæt 8x8mm, m/massiv roset cc 38mm, 59-85mm

14.0512.02.020

Sæt 8x8mm, m/klipsroset cc 30/38mm, 33-59mm

14.0516.02.017

Sæt 8x8mm, m/klipsroset cc 30/38mm, 59-85mm

14.0516.02.025



Halvt sæt 7x7mm, m/klipsroset cc 30/38mm

14.0556.02.900

Halvt sæt 8x8mm, m/massiv roset cc 30mm

14.0511.02.900

Halvt sæt 8x8mm, m/massiv roset cc 38mm

14.0512.02.900

Halvt sæt 8x8mm, m/klipsroset cc 30/38mm

14.0516.02.904



Halvt sæt 7x7mm, u/roset

14.0550.02.900

Halvt sæt 8x8mm, u/roset

14.0510.02.900

EN1906:2010



CLASS 4

Dørgreb Coupe



Dørgreb Coupe

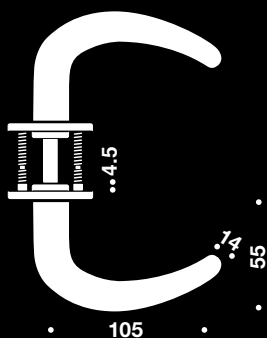

Beskrivelse

Sæt 7x7mm, m/klipsroset cc 30/38mm, 33-59mm

Varenummer

14.1156.02.010

Sæt 8x8mm, m/massiv roset cc 30mm, 33-59mm

14.1111.02.010

Sæt 8x8mm, m/massiv roset cc 30mm, 59-85mm

14.1111.02.020

Sæt 8x8mm, m/massiv roset cc 38mm, 33-59mm

14.1112.02.010

Sæt 8x8mm, m/massiv roset cc 38mm, 59-85mm

14.1112.02.020

Sæt 8x8mm, m/klipsroset cc 30/38mm, 33-59mm

14.1116.02.010

Sæt 8x8mm, m/klipsroset cc 30/38mm, 59-85mm

14.1116.02.020

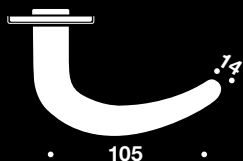

Halvt sæt 7x7mm, m/klipsroset cc 30/38mm

14.1156.02.900

Halvt sæt 8x8mm, m/massiv roset cc 30mm

14.1111.02.900

Halvt sæt 8x8mm, m/massiv roset cc 38mm

14.1112.02.900

Halvt sæt 8x8mm, m/klipsroset cc 30/38mm

14.1116.02.900



Halvt sæt 7x7mm, u/roset

14.1150.02.900

Halvt sæt 8x8mm, u/roset

14.1111.02.010

EN1906:2010



CLASS 4

Dørgreb L form 16mm



Dørgreb L form 16mm

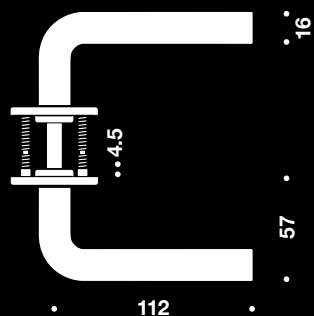

Beskrivelse

Sæt 7x7mm, m/klipsroset cc 30/38mm, 33-59mm

Sæt 7x7mm, m/klipsroset cc 30/38mm, 59-85mm

Sæt 8x8mm, m/massiv roset cc 30mm, 33-59mm

Sæt 8x8mm, m/massiv roset cc 30mm, 59-85mm

Sæt 8x8mm, m/massiv roset cc 38mm, 33-59mm

Sæt 8x8mm, m/massiv roset cc 38mm, 59-85mm

Sæt 8x8mm, m/klipsroset cc 30/38mm, 33-59mm

Sæt 8x8mm, m/klipsroset cc 30/38mm, 59-85mm

Varenummer

14.1056.02.010

14.1056.02.020

14.1011.02.018

14.1011.02.026

14.1012.02.012

14.1012.02.021

14.1016.02.011

14.1016.02.029



Halvt sæt 7x7mm, m/klipsroset cc 30/38mm

14.1056.02.900

Halvt sæt 8x8mm, m/massiv roset cc 30mm

14.1011.02.900

Halvt sæt 8x8mm, m/massiv roset cc 38mm

14.1012.02.900

Halvt sæt 8x8mm, m/klipsroset cc 30/38mm

14.1016.02.908



Halvt sæt 7x7mm, u/roset

14.1050.02.900

Halvt sæt 8x8mm, u/roset

14.1010.02.901

Dørgreb U form 16mm



Dørgreb U form 16mm

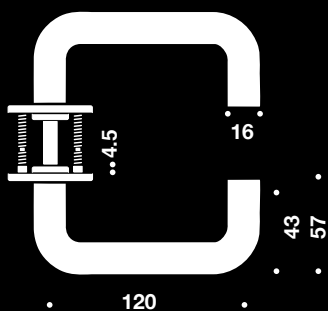

Beskrivelse

Sæt 7x7mm, m/klipsroset cc 30/38mm, 33-59mm

Sæt 7x7mm, m/klipsroset cc 30/38mm, 59-85mm

Sæt 8x8mm, m/massiv roset cc 30mm, 33-59mm

Sæt 8x8mm, m/massiv roset cc 30mm, 59-85mm

Sæt 8x8mm, m/massiv roset cc 38mm, 33-59mm

Sæt 8x8mm, m/massiv roset cc 38mm, 59-85mm

Sæt 8x8mm, m/klipsroset cc 30/38mm, 33-59mm

Sæt 8x8mm, m/klipsroset cc 30/38mm, 59-85mm

Varenummer

14.1256.02.010

14.1256.02.020

14.1211.02.014

14.1211.02.020

14.1212.02.010

14.1212.02.020

14.1216.02.017

14.1216.02.025

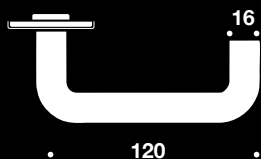

Halvt sæt 7x7mm, m/klipsroset cc 30/38mm

14.1256.02.900

Halvt sæt 8x8mm, m/massiv roset cc 30mm

14.1211.02.900

Halvt sæt 8x8mm, m/massiv roset cc 38mm

14.1212.02.900

Halvt sæt 8x8mm, m/klipsroset cc 30/38mm

14.1216.02.904

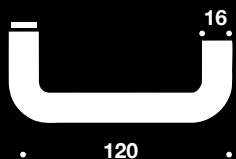

Halvt sæt 7x7mm, u/roset

14.1250.02.900

Halvt sæt 8x8mm, u/roset

14.1210.02.907

EN1906:2010



CLASS 4

Dørgreb C form 16mm



Dørgreb C form 16mm

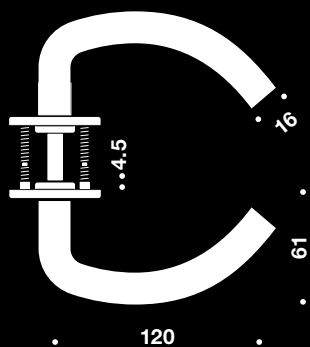

Beskrivelse

Sæt 7x7mm, m/klipsroset cc 30/38mm, 33-59mm

Sæt 7x7mm, m/klipsroset cc 30/38mm, 59-85mm

Sæt 8x8mm, m/massiv roset cc 30mm, 33-59mm

Sæt 8x8mm, m/massiv roset cc 30mm, 59-85mm

Sæt 8x8mm, m/massiv roset cc 38mm, 33-59mm

Sæt 8x8mm, m/massiv roset cc 38mm, 59-85mm

Sæt 8x8mm, m/klipsroset cc 30/38mm, 33-59mm

Sæt 8x8mm, m/klipsroset cc 30/38mm, 59-85mm

Varenummer

14.2656.02.010

14.2656.02.020

14.2611.02.011

14.2611.02.020

14.2612.02.010

14.2612.02.020

14.2616.02.010

14.2616.02.020

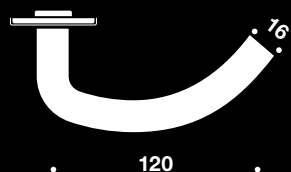

Halvt sæt 7x7mm, m/klipsroset cc 30/38mm

Halvt sæt 8x8mm, m/massiv roset cc 30mm

Halvt sæt 8x8mm, m/massiv roset cc 38mm

Halvt sæt 8x8mm, m/klipsroset cc 30/38mm

14.2656.02.900

14.2611.02.900

14.2612.02.900

14.2616.02.900

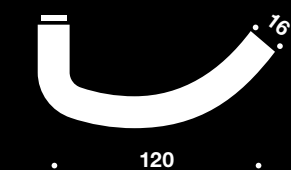

Halvt sæt 7x7mm, u/roset

Halvt sæt 8x8mm, u/roset

14.2650.02.900

14.2610.02.900

EN1906:2010



CLASS 4

Dørgreb U2 form 16mm



Dørgreb U2 form 16mm

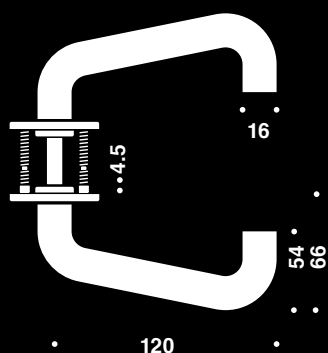

Beskrivelse

Sæt 7x7mm, m/klipsroset cc 30/38mm, 33-59mm

Sæt 7x7mm, m/klipsroset cc 30/38mm, 59-85mm

Sæt 8x8mm, m/massiv roset cc 30mm, 33-59mm

Sæt 8x8mm, m/massiv roset cc 30mm, 59-85mm

Sæt 8x8mm, m/massiv roset cc 38mm, 33-59mm

Sæt 8x8mm, m/massiv roset cc 38mm, 59-85mm

Sæt 8x8mm, m/klipsroset cc 30/38mm, 33-59mm

Sæt 8x8mm, m/klipsroset cc 30/38mm, 59-85mm

Varenummer

14.0656.02.010

14.0656.02.020

14.0611.02.010

14.0611.02.020

14.0612.02.010

14.0612.02.020

14.0616.02.010

14.0616.02.020

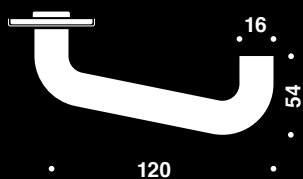

Halvt sæt 7x7mm, m/klipsroset cc 30/38mm

14.0656.02.900

Halvt sæt 8x8mm, m/massiv roset cc 30mm

14.0611.02.900

Halvt sæt 8x8mm, m/massiv roset cc 38mm

14.0612.02.900

Halvt sæt 8x8mm, m/klipsroset cc 30/38mm

14.0616.02.900

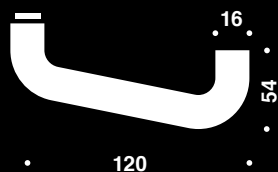

Halvt sæt 7x7mm, u/roset

14.0650.02.900

Halvt sæt 8x8mm, u/roset

14.0610.02.900

Dørgreb M form 16mm



Dørgreb M form 16mm

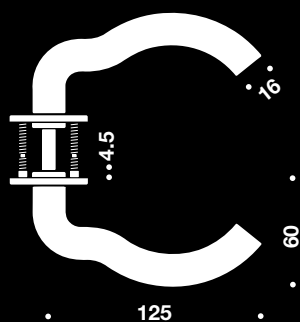

Beskrivelse

Sæt 7x7mm, m/klipsroset cc 30/38mm, 33-44mm

Sæt 7x7mm, m/klipsroset cc 30/38mm, 44-60mm

Sæt 8x8mm, m/massiv roset cc 30mm, 33-44mm

Sæt 8x8mm, m/massiv roset cc 30mm, 44-60mm

Sæt 8x8mm, m/massiv roset cc 38mm, 33-44mm

Sæt 8x8mm, m/massiv roset cc 38mm, 44-60mm

Sæt 8x8mm, m/klipsroset cc 30/38mm, 33-44mm

Sæt 8x8mm, m/klipsroset cc 30/38mm, 44-60mm

Varenummer

14.1356.02.010

14.1356.02.020

14.1311.02.012

14.1311.02.020

14.1312.02.010

14.1312.02.020

14.1316.02.015

14.1316.02.020

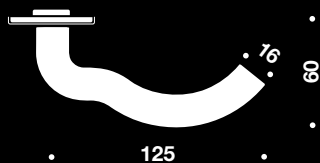

Halvt sæt 7x7mm, m/klipsroset cc 30/38mm

14.1356.02.900

Halvt sæt 8x8mm, m/massiv roset cc 30mm

14.1311.02.900

Halvt sæt 8x8mm, m/massiv roset cc 38mm

14.1312.02.900

Halvt sæt 8x8mm, m/klipsroset cc 30/38mm

14.1316.02.902

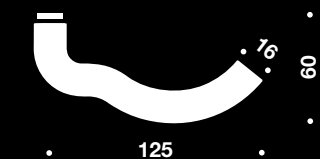

Halvt sæt 7x7mm, u/roset

14.1350.02.900

Halvt sæt 8x8mm, u/roset

14.1310.02.905

EN1906:2010



CLASS 4

Dørgreb LF form 16mm



Dørgreb LF form 16mm

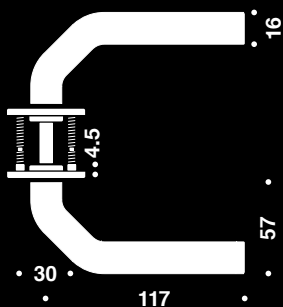

Beskrivelse

Sæt 7x7mm, m/klipsroset cc 30/38mm, 33-41mm

Sæt 7x7mm, m/klipsroset cc 30/38mm, 41-49mm

Sæt 8x8mm, m/massiv roset cc 30mm, 33-41mm

Sæt 8x8mm, m/massiv roset cc 30mm, 41-49mm

Sæt 8x8mm, m/massiv roset cc 38mm, 33-41mm

Sæt 8x8mm, m/massiv roset cc 38mm, 41-49mm

Sæt 8x8mm, m/klipsroset cc 30/38mm, 33-41mm

Sæt 8x8mm, m/klipsroset cc 30/38mm, 41-49mm

Varenummer

14.1556.02.010

14.1556.02.020

14.1511.02.010

14.1511.02.020

14.1512.02.010

14.1512.02.020

14.1516.02.010

14.1516.02.020

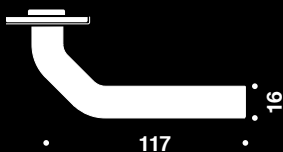

Halvt sæt 7x7mm, m/klipsroset cc 30/38mm

14.1556.02.900

Halvt sæt 8x8mm, m/massiv roset cc 30mm

14.1511.02.900

Halvt sæt 8x8mm, m/massiv roset cc 38mm

14.1512.02.900

Halvt sæt 8x8mm, m/klipsroset cc 30/38mm

14.1516.02.900

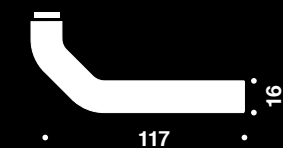

Halvt sæt 7x7mm, u/roset

14.1550.02.900

Halvt sæt 8x8mm, u/roset

14.1510.02.900

EN1906:2010



CLASS 4

Dørgreb UF form 16mm



Dørgreb UF form 16mm

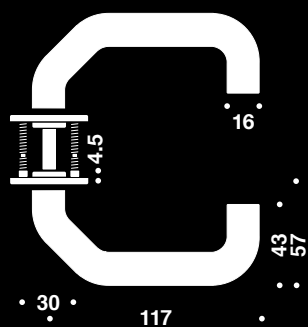

Beskrivelse

Sæt 7x7mm, m/klipsroset cc 30/38mm, 33-41mm

Sæt 7x7mm, m/klipsroset cc 30/38mm, 41-49mm

Sæt 8x8mm, m/massiv roset cc 30mm, 33-41mm

Sæt 8x8mm, m/massiv roset cc 30mm, 41-49mm

Sæt 8x8mm, m/massiv roset cc 38mm, 33-41mm

Sæt 8x8mm, m/massiv roset cc 38mm, 41-49mm

Sæt 8x8mm, m/klipsroset cc 30/38mm, 33-41mm

Sæt 8x8mm, m/klipsroset cc 30/38mm, 41-49mm

Varenummer

14.1456.02.010

14.1456.02.020

14.1411.02.010

14.1411.02.020

14.1412.02.010

14.1412.02.020

14.1416.02.010

14.1416.02.020

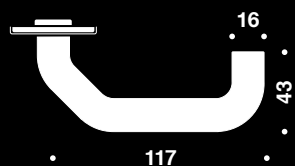

Halvt sæt 7x7mm, m/klipsroset cc 30/38mm

14.1456.02.900

Halvt sæt 8x8mm, m/massiv roset cc 30mm

14.1411.02.900

Halvt sæt 8x8mm, m/massiv roset cc 38mm

14.1412.02.900

Halvt sæt 8x8mm, m/klipsroset cc 30/38mm

14.1416.02.900

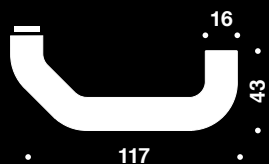

Halvt sæt 7x7mm, u/roset

14.1450.02.900

Halvt sæt 8x8mm, u/roset

14.1410.02.903

EN1906:2010



CLASS 4

Dørgreb LF form 16mm



Dørgreb LF form 16mm

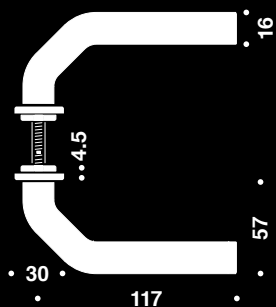

Beskrivelse

Sæt 7x7mm, m/oval klipsroset cc 50mm, 33-41mm

Sæt 7x7mm, m/oval klipsroset cc 50mm, 41-49mm

Sæt 8x8mm, m/oval massiv roset cc 50mm, 33-41mm

Sæt 8x8mm, m/oval massiv roset cc 50mm, 41-49mm

Sæt 8x8mm, m/oval klipsroset cc 50mm, 33-41mm

Sæt 8x8mm, m/oval klipsroset cc 50mm, 41-49mm

Varenummer

14.1557.02.010

14.1557.02.020

14.1514.02.010

14.1514.02.020

14.1517.02.010

14.1517.02.020

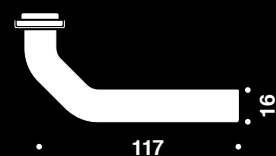

Halvt sæt 7x7mm, m/oval klipsroset cc 50mm

14.1557.02.900

Halvt sæt 8x8mm, m/oval massiv roset cc 50mm

14.1514.02.900

Halvt sæt 8x8mm, m/oval klipsroset cc 50mm

14.1517.02.900

EN1906:2010



CLASS 4

Dørgreb UF form 16mm



Dørgreb UF form 16mm

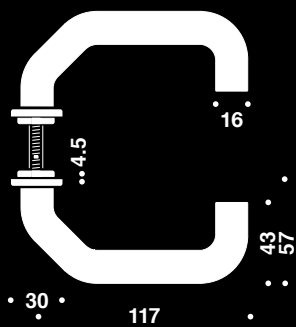

Beskrivelse

Sæt 7x7mm, m/oval klipsroset cc 50mm, 33-41mm

Sæt 7x7mm, m/oval klipsroset cc 50mm, 41-49mm

Sæt 8x8mm, m/oval massiv roset cc 50mm, 33-41mm

Sæt 8x8mm, m/oval massiv roset cc 50mm, 41-49mm

Sæt 8x8mm, m/oval klipsroset cc 50mm, 33-41mm

Sæt 8x8mm, m/oval klipsroset cc 50mm, 41-49mm

Varenummer

14.1457.02.010

14.1457.02.020

14.1414.02.010

14.1414.02.020

14.1417.02.018

14.1417.02.026

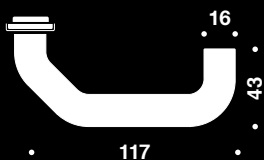

Halvt sæt 7x7mm, m/oval klipsroset cc 50mm

14.1457.02.900

Halvt sæt 8x8mm, m/oval massiv roset cc 50mm

14.1414.02.900

Halvt sæt 8x8mm, m/oval klipsroset cc 50mm

14.1417.02.900

EN1906:2010



CLASS 4

Dørgreb L form 19mm



Dørgreb L form 19mm

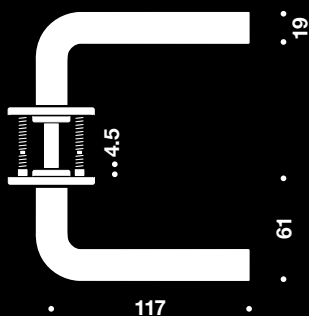

Beskrivelse

Sæt 7x7mm, m/klipsroset cc 30/38mm, 33-59mm

Sæt 7x7mm, m/klipsroset cc 30/38mm, 59-85mm

Sæt 8x8mm, m/massiv roset cc 30mm, 33-59mm

Sæt 8x8mm, m/massiv roset cc 30mm, 59-85mm

Sæt 8x8mm, m/massiv roset cc 38mm, 33-59mm

Sæt 8x8mm, m/massiv roset cc 38mm, 59-85mm

Sæt 8x8mm, m/klipsroset cc 30/38mm, 33-59mm

Sæt 8x8mm, m/klipsroset cc 30/38mm, 59-85mm

Sæt 9x9mm, m/klipsroset cc 38mm, 33-59mm

Sæt 9x9mm, m/klipsroset cc 38mm, 59-85mm

Varenummer

14.1656.02.010

14.1656.02.020

14.1611.02.017

14.1611.02.025

14.1612.02.010

14.1612.02.020

14.1616.02.010

14.1616.02.028

14.1636.02.017

14.1636.02.025



Halvt sæt 7x7mm, m/klipsroset cc 30/38mm

Halvt sæt 8x8mm, m/massiv roset cc 30mm

Halvt sæt 8x8mm, m/massiv roset cc 38mm

Halvt sæt 8x8mm, m/klipsroset cc 30/38mm

Halvt sæt 9x9mm, m/klipsroset cc 38mm

14.1656.02.900

14.1611.02.900

14.1612.02.900

14.1616.02.907

14.1636.02.904



Halvt sæt 7x7mm, u/roset

Halvt sæt 8x8mm, u/roset

Halvt sæt 9x9mm, u/roset

14.1650.02.900

14.1610.02.900

14.1630.02.907

EN1906:2010



Dørgreb godkendt til branddøre i henhold til DIN 18273

Dørgreb U form 19mm



Dørgreb U form 19mm

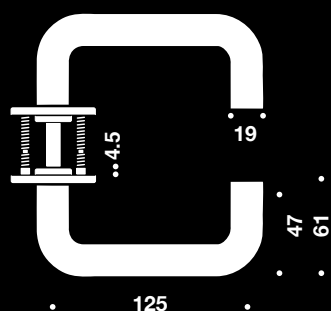

Beskrivelse

Sæt 7x7mm, m/klipsroset cc 30/38mm, 33-59mm

Sæt 7x7mm, m/klipsroset cc 30/38mm, 59-85mm

Sæt 8x8mm, m/massiv roset cc 30mm, 33-59mm

Sæt 8x8mm, m/massiv roset cc 30mm, 59-85mm

Sæt 8x8mm, m/massiv roset cc 38mm, 33-59mm

Sæt 8x8mm, m/massiv roset cc 38mm, 59-85mm

Sæt 8x8mm, m/klipsroset cc 30/38mm, 33-59mm

Sæt 8x8mm, m/klipsroset cc 30/38mm, 59-85mm

Sæt 9x9mm, m/klipsroset cc 38mm, 33-59mm

Sæt 9x9mm, m/klipsroset cc 38mm, 59-85mm

Varenummer

14.1856.02.010

14.1856.02.020

14.1811.02.013

14.1811.02.021

14.1812.02.010

14.1812.02.020

14.1816.02.016

14.1816.02.024

14.1836.02.013

14.1836.02.021



Halvt sæt 7x7mm, m/klipsroset cc 30/38mm

Halvt sæt 8x8mm, m/massiv roset cc 30mm

Halvt sæt 8x8mm, m/massiv roset cc 38mm

Halvt sæt 8x8mm, m/klipsroset cc 30/38mm

Halvt sæt fast funktion, m/klipsroset cc 30/38mm, M8

Halvt sæt fast funktion, m/klipsroset cc 30/38mm, bøsning

Halvt sæt 9x9mm, m/klipsroset cc 38mm

14.1856.02.900

14.1811.02.900

14.1812.02.900

14.1816.02.903

14.1850.02.120

14.1850.02.140

14.1836.02.901



Halvt sæt 7x7mm, u/roset

Halvt sæt 8x8mm, u/roset

14.1850.02.900

14.1810.02.906



Dørgreb godkendt til branddøre i henhold til DIN 18273



Dørgreb godkendt til DIN 179

Dørgreb C form 19mm



Dørgreb C form 19mm

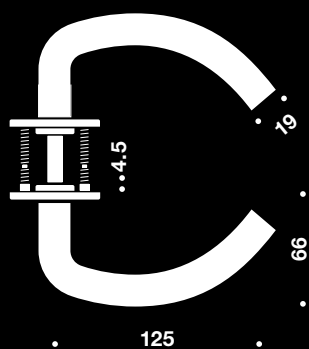

Beskrivelse

Sæt 7x7mm, m/klipsroset cc 30/38mm, 33-59mm

Sæt 7x7mm, m/klipsroset cc 30/38mm, 59-85mm

Sæt 8x8mm, m/massiv roset cc 30mm, 33-59mm

Sæt 8x8mm, m/massiv roset cc 30mm, 59-85mm

Sæt 8x8mm, m/massiv roset cc 38mm, 33-59mm

Sæt 8x8mm, m/massiv roset cc 38mm, 59-85mm

Sæt 8x8mm, m/klipsroset cc 30/38mm, 33-59mm

Sæt 8x8mm, m/klipsroset cc 30/38mm, 59-85mm

Sæt 9x9mm, m/klipsroset cc 38mm, 33-59mm

Sæt 9x9mm, m/klipsroset cc 38mm, 59-85mm

Varenummer

14.2356.02.010

14.2356.02.020

14.2311.02.010

14.2311.02.020

14.2312.02.010

14.2312.02.020

14.2316.02.010

14.2316.02.020

14.2336.02.010

14.2336.02.020



Halvt sæt 7x7mm, m/klipsroset cc 30/38mm

Halvt sæt 8x8mm, m/massiv roset cc 30mm

Halvt sæt 8x8mm, m/massiv roset cc 38mm

Halvt sæt 8x8mm, m/klipsroset cc 30/38mm

Halvt sæt 9x9mm, m/klipsroset cc 38mm

14.2356.02.900

14.2311.02.900

14.2312.02.900

14.2316.02.900

14.2336.02.900

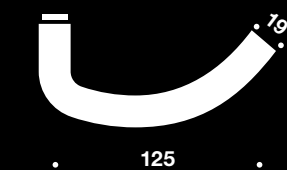

Halvt sæt 7x7mm, u/roset

Halvt sæt 8x8mm, u/roset

Halvt sæt 9x9mm, u/roset

14.2350.02.900

14.2310.02.900

14.2330.02.900



Dørgreb godkendt til branddøre i henhold til DIN 18273

Dørgreb U2 form 19mm



Dørgreb U2 form 19mm

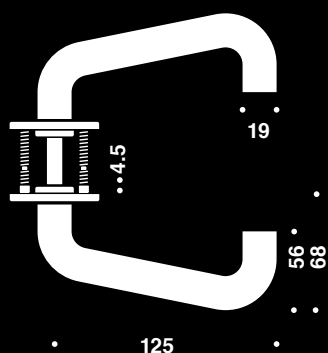

Beskrivelse

Sæt 7x7mm, m/klipsroset cc 30/38mm, 33-59mm

Sæt 7x7mm, m/klipsroset cc 30/38mm, 59-85mm

Sæt 8x8mm, m/massiv roset cc 30mm, 33-59mm

Sæt 8x8mm, m/massiv roset cc 30mm, 59-85mm

Sæt 8x8mm, m/massiv roset cc 38mm, 33-59mm

Sæt 8x8mm, m/massiv roset cc 38mm, 59-85mm

Sæt 8x8mm, m/klipsroset cc 30/38mm, 33-59mm

Sæt 8x8mm, m/klipsroset cc 30/38mm, 59-85mm

Sæt 9x9mm, m/klipsroset cc 38mm, 33-59mm

Sæt 9x9mm, m/klipsroset cc 38mm, 59-85mm

Varenummer

14.0856.02.010

14.0856.02.020

14.0811.02.010

14.0811.02.020

14.0812.02.010

14.0812.02.020

14.0816.02.010

14.0816.02.020

14.0836.02.010

14.0836.02.020

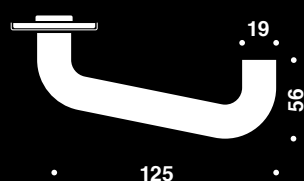

Halvt sæt 7x7mm, m/klipsroset cc 30/38mm

14.0856.02.900

Halvt sæt 8x8mm, m/massiv roset cc 30mm

14.0811.02.900

Halvt sæt 8x8mm, m/massiv roset cc 38mm

14.0812.02.900

Halvt sæt 8x8mm, m/klipsroset cc 30/38mm

14.0816.02.900

Halvt sæt 9x9mm, m/klipsroset cc 38mm

14.0836.02.900

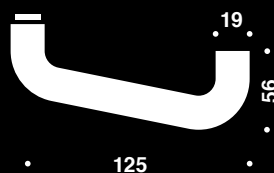

Halvt sæt 7x7mm, u/roset

14.0850.02.900

Halvt sæt 8x8mm, u/roset

14.0810.02.900

Halvt sæt 9x9mm, u/roset

14.0830.02.900



Dørgreb godkendt til branddøre i henhold til DIN 18273

Dørgreb C2 form 19mm

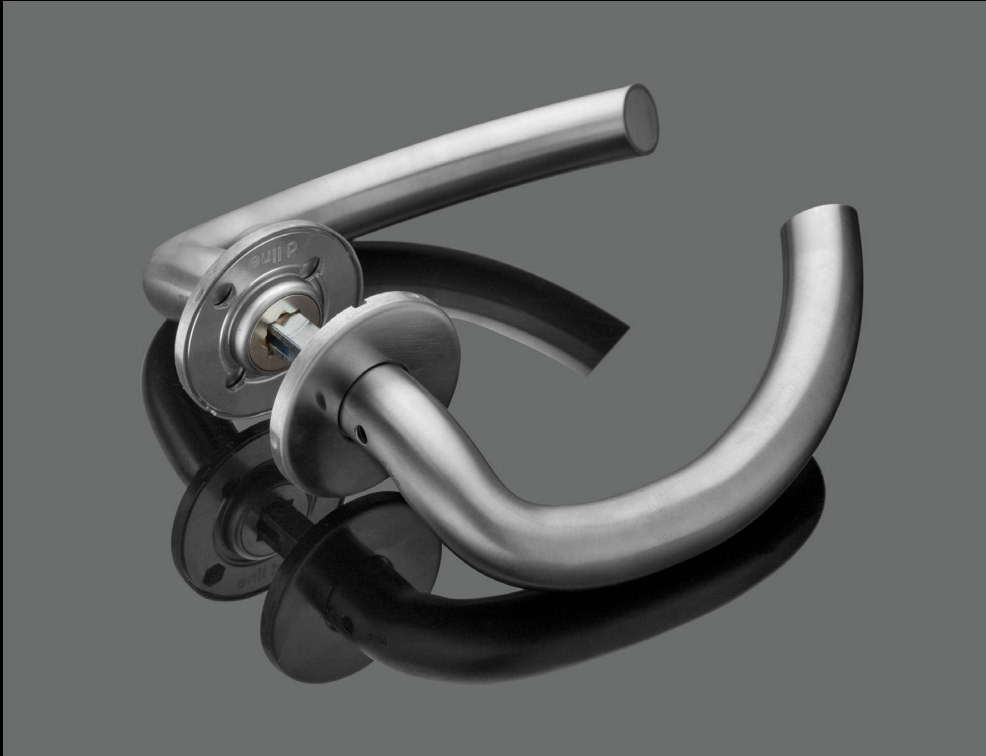

Dørgreb C2 form 19mm

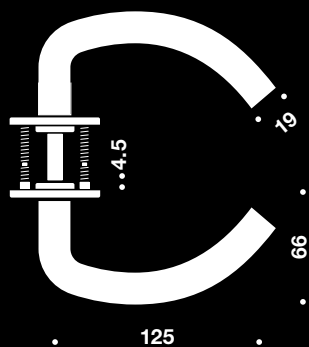

Beskrivelse

Sæt 7x7mm, m/klipsroset cc 30/38mm, 33-59mm
 Sæt 7x7mm, m/klipsroset cc 30/38mm, 59-85mm

Varenummer

14.0956.02.010
 14.0956.02.020

Sæt 8x8mm, m/massiv roset cc 30mm, 33-59mm
 Sæt 8x8mm, m/massiv roset cc 30mm, 59-85mm

14.0911.02.010
 14.0911.02.020

Sæt 8x8mm, m/massiv roset cc 38mm, 33-59mm
 Sæt 8x8mm, m/massiv roset cc 38mm, 59-85mm

14.0912.02.010
 14.0912.02.020

Sæt 8x8mm, m/klipsroset cc 30/38mm, 33-59mm
 Sæt 8x8mm, m/klipsroset cc 30/38mm, 59-85mm

14.0916.02.010
 14.0916.02.020

Sæt 9x9mm, m/klipsroset cc 38mm, 33-59mm
 Sæt 9x9mm, m/klipsroset cc 38mm, 59-85mm

14.0936.02.010
 14.0936.02.020

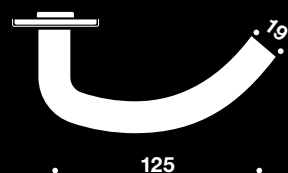

Halvt sæt 7x7mm, m/klipsroset cc 30/38mm, H
 Halvt sæt 7x7mm, m/klipsroset cc 30/38mm, V

14.0956.02.920
 14.0956.02.930

Halvt sæt 8x8mm, m/massiv roset cc 30mm, H
 Halvt sæt 8x8mm, m/massiv roset cc 30mm, V
 Halvt sæt 8x8mm, m/massiv roset cc 38mm, H
 Halvt sæt 8x8mm, m/massiv roset cc 38mm, V

14.0911.02.920
 14.0911.02.930
 14.0912.02.920
 14.0912.02.930

Halvt sæt 8x8mm, m/klipsroset cc 30/38mm, H
 Halvt sæt 8x8mm, m/klipsroset cc 30/38mm, V

14.0916.02.920
 14.0916.02.930

Halvt sæt 9x9mm, m/klipsroset cc 38mm, H
 Halvt sæt 9x9mm, m/klipsroset cc 38mm, V

14.0936.02.920
 14.0936.02.930

Halvt sæt 7x7mm, u/roset, H
 Halvt sæt 7x7mm, u/roset, V

14.0950.02.920
 14.0950.02.930

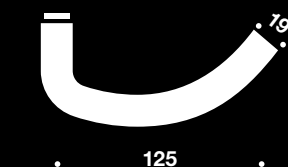

Halvt sæt 8x8mm, u/roset, H
 Halvt sæt 8x8mm, u/roset, V

14.0910.02.920
 14.0910.02.930

Halvt sæt 9x9mm, u/roset, H
 Halvt sæt 9x9mm, u/roset, V

14.0930.02.920
 14.0930.02.930



Dørgreb godkendt
 til branddøre i hen-
 hold til DIN 18273

Dørgreb M form 19mm



Dørgreb M form 19mm

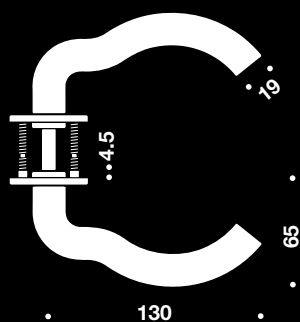

Beskrivelse

Sæt 7x7mm, m/klipsroset cc 30/38mm, 33-44mm

Sæt 7x7mm, m/klipsroset cc 30/38mm, 44-60mm

Sæt 8x8mm, m/massiv roset cc 30mm, 33-44mm

Sæt 8x8mm, m/massiv roset cc 30mm, 44-60mm

Sæt 8x8mm, m/massiv roset cc 38mm, 33-44mm

Sæt 8x8mm, m/massiv roset cc 38mm, 44-60mm

Sæt 8x8mm, m/klipsroset cc 30/38mm, 33-44mm

Sæt 8x8mm, m/klipsroset cc 30/38mm, 44-60mm

Varenummer

14.1956.02.010

14.1956.02.020

14.1911.02.010

14.1911.02.020

14.1912.02.010

14.1912.02.020

14.1916.02.014

14.1916.02.022

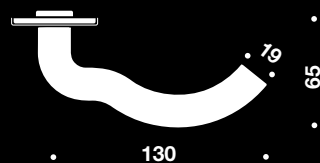

Halvt sæt 7x7mm, m/klipsroset cc 30/38mm

14.1956.02.900

Halvt sæt 8x8mm, m/massiv roset cc 30mm

14.1911.02.900

Halvt sæt 8x8mm, m/massiv roset cc 38mm

14.1912.02.900

Halvt sæt 8x8mm, m/klipsroset cc 30/38mm

14.1916.02.900

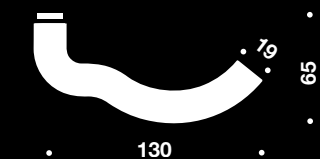

Halvt sæt 7x7mm, u/roset

14.1950.02.900

Halvt sæt 8x8mm, u/roset

14.1910.02.900

EN1906:2010



CLASS 4

Dørgreb LF form 19mm



Dørgreb LF form 19mm

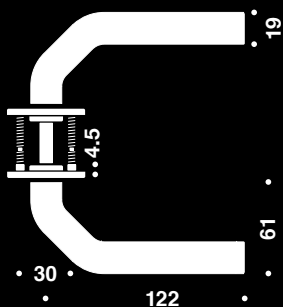

Beskrivelse

Sæt 7x7mm, m/klipsroset cc 30/38mm, 33-44mm

Sæt 7x7mm, m/klipsroset cc 30/38mm, 44-52mm

Sæt 8x8mm, m/massiv roset cc 30mm, 33-44mm

Sæt 8x8mm, m/massiv roset cc 30mm, 44-52mm

Sæt 8x8mm, m/massiv roset cc 38mm, 33-44mm

Sæt 8x8mm, m/massiv roset cc 38mm, 44-52mm

Sæt 8x8mm, m/klipsroset cc 30/38mm, 33-44mm

Sæt 8x8mm, m/klipsroset cc 30/38mm, 44-52mm

Sæt 9x9mm, m/klipsroset cc 38mm, 33-44mm

Sæt 9x9mm, m/klipsroset cc 38mm, 44-52mm

Varenummer

14.2156.02.010

14.2156.02.020

14.2111.02.010

14.2111.02.020

14.2112.02.010

14.2112.02.020

14.2116.02.010

14.2116.02.020

14.2136.02.010

14.2136.02.020

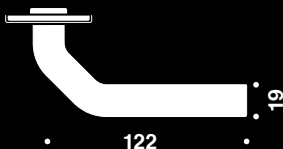

Halvt sæt 7x7mm, m/klipsroset cc 30/38mm

14.2156.02.900

Halvt sæt 8x8mm, m/massiv roset cc 30mm

14.2111.02.900

Halvt sæt 8x8mm, m/massiv roset cc 38mm

14.2112.02.900

Halvt sæt 8x8mm, m/klipsroset cc 30/38mm

14.2116.02.900

Halvt sæt 9x9mm, m/klipsroset cc 38mm

14.2136.02.900

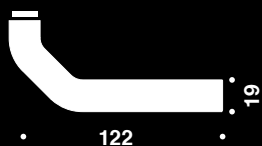

Halvt sæt 7x7mm, u/roset

14.2150.02.900

Halvt sæt 8x8mm, u/roset

14.2110.02.900

Halvt sæt 9x9mm, u/roset

14.2130.02.900

EN1906:2010



Dørgreb godkendt til branddøre i henhold til DIN 18273

Dørgreb UF form 19mm



Dørgreb UF form 19mm

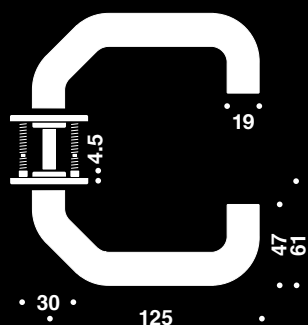

Beskrivelse

Sæt 7x7mm, m/klipsroset cc 30/38mm, 33-44mm

Sæt 7x7mm, m/klipsroset cc 30/38mm, 44-52mm

Sæt 8x8mm, m/massiv roset cc 30mm, 33-44mm

Sæt 8x8mm, m/massiv roset cc 30mm, 44-52mm

Sæt 8x8mm, m/massiv roset cc 38mm, 33-44mm

Sæt 8x8mm, m/massiv roset cc 38mm, 44-52mm

Sæt 8x8mm, m/klipsroset cc 30/38mm, 33-44mm

Sæt 8x8mm, m/klipsroset cc 30/38mm, 44-52mm

Sæt 9x9mm, m/klipsroset cc 38mm, 33-44mm

Sæt 9x9mm, m/klipsroset cc 38mm, 44-52mm

Varenummer

14.2056.02.010

14.2056.02.020

14.2011.02.010

14.2011.02.020

14.2012.02.010

14.2012.02.020

14.2016.02.010

14.2016.02.020

14.2036.02.010

14.2036.02.020

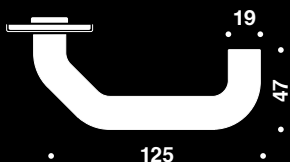

Halvt sæt 7x7mm, m/klipsroset cc 30/38mm

Halvt sæt 8x8mm, m/massiv roset cc 30mm

Halvt sæt 8x8mm, m/massiv roset cc 38mm

Halvt sæt 8x8mm, m/klipsroset cc 30/38mm

Halvt sæt 9x9mm, m/klipsroset cc 38mm

14.2056.02.900

14.2011.02.900

14.2012.02.900

14.2016.02.900

14.2036.02.900

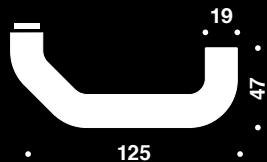

Halvt sæt 7x7mm, u/roset

Halvt sæt 8x8mm, u/roset

Halvt sæt 9x9mm, u/roset

14.2050.02.900

14.2010.02.908

14.2030.02.900



Dørgreb godkendt til branddøre i henhold til DIN 18273



Dørgreb godkendt til DIN 179

Dørgreb LF form 19mm



Dørgreb LF form 19mm

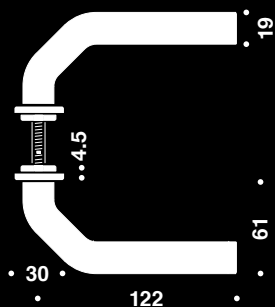

Beskrivelse

Sæt 7x7mm, m/oval klipsroset cc 50mm, 33-44mm

Sæt 7x7mm, m/oval massiv roset cc 50mm, 44-52mm

Sæt 8x8mm, m/oval massiv roset cc 50mm, 33-44mm

Sæt 8x8mm, m/oval massiv roset cc 50mm, 44-52mm

Sæt 8x8mm, m/oval klipsroset cc 50mm, 33-44mm

Sæt 8x8mm, m/oval klipsroset cc 50mm, 44-52mm

Sæt 9x9mm, m/oval klipsroset cc 50mm, 33-44mm

Sæt 9x9mm, m/oval klipsroset cc 50mm, 44-52mm

Varenummer

14.2157.02.010

14.2157.02.020

14.2114.02.010

14.2114.02.020

14.2117.02.010

14.2117.02.020

14.2137.02.010

14.2137.02.020

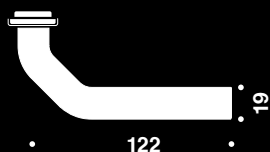

Halvt sæt 7x7mm, m/oval klipsroset cc 50mm

14.2157.02.900

Halvt sæt 8x8mm, m/oval massiv roset cc 50mm

14.2114.02.900

Halvt sæt 8x8mm, m/oval klipsroset cc 50mm

14.2117.02.900

Halvt sæt 9x9mm, m/oval klipsroset cc 50mm

14.2137.02.900



Dørgreb godkendt til branddøre i henhold til DIN 18273

Dørgreb UF form 19mm



Dørgreb UF form 19mm

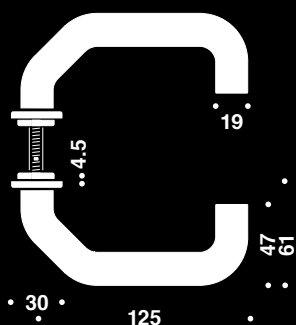

Beskrivelse

Sæt 7x7mm, m/oval klipsroset cc 50mm, 33-44mm

Sæt 7x7mm, m/oval massiv roset cc 50mm, 44-52mm

Sæt 8x8mm, m/oval massiv roset cc 50mm, 33-44mm

Sæt 8x8mm, m/oval massiv roset cc 50mm, 44-52mm

Sæt 8x8mm, m/oval klipsroset cc 50mm, 33-44mm

Sæt 8x8mm, m/oval klipsroset cc 50mm, 44-52mm

Sæt 9x9mm, m/oval klipsroset cc 50mm, 33-44mm

Sæt 9x9mm, m/oval klipsroset cc 50mm, 44-52mm

Varenummer

14.2057.02.010

14.2057.02.020

14.2014.02.010

14.2014.02.020

14.2017.02.012

14.2017.02.021

14.2037.02.010

14.2037.02.020

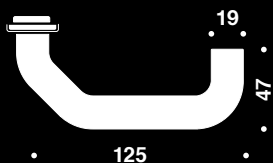

Halvt sæt 7x7mm, m/oval klipsroset cc 50mm

14.2057.02.900

Halvt sæt 8x8mm, m/oval massiv roset cc 50mm

14.2014.02.900

Halvt sæt 8x8mm, m/oval klipsroset cc 50mm

14.2017.02.900

Halvt sæt 9x9mm, m/oval klipsroset cc 50mm

14.2037.02.900



Dørgreb godkendt til branddøre i henhold til DIN 18273



Dørgreb godkendt til DIN 179

Dørgreb B form 19mm



Dørgreb B form 19mm

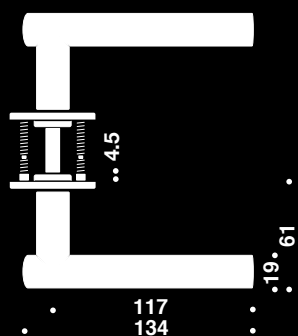

Beskrivelse

Sæt 7x7mm, m/klipsroset cc 30/38mm, 33-59mm
 Sæt 7x7mm, m/klipsroset cc 30/38mm, 59-85mm

Varenummer

14.2456.02.010
 14.2456.02.020

Sæt 8x8mm, m/massiv roset cc 30mm, 33-59mm
 Sæt 8x8mm, m/massiv roset cc 30mm, 59-85mm

14.2411.02.010
 14.2411.02.020

Sæt 8x8mm, m/massiv roset cc 38mm, 33-59mm
 Sæt 8x8mm, m/massiv roset cc 38mm, 59-85mm

14.2412.02.010
 14.2412.02.020

Sæt 8x8mm, m/klipsroset cc 30/38mm, 33-59mm
 Sæt 8x8mm, m/klipsroset cc 30/38mm, 59-85mm

14.2416.02.010
 14.2416.02.020

Sæt 9x9mm, m/klipsroset cc 38mm, 33-59mm
 Sæt 9x9mm, m/klipsroset cc 38mm, 59-85mm

14.2436.02.010
 14.2436.02.020

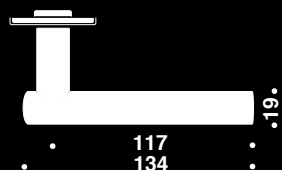

Halvt sæt 7x7mm, m/klipsroset cc 30/38mm, H
 Halvt sæt 7x7mm, m/klipsroset cc 30/38mm, V

14.2456.02.920
 14.2456.02.930

Halvt sæt 8x8mm, m/massiv roset cc 30mm, H
 Halvt sæt 8x8mm, m/massiv roset cc 30mm, V
 Halvt sæt 8x8mm, m/massiv roset cc 38mm, H
 Halvt sæt 8x8mm, m/massiv roset cc 38mm, V

14.2411.02.920
 14.2411.02.930
 14.2412.02.920
 14.2412.02.930

Halvt sæt 8x8mm, m/klipsroset cc 30/38mm, H
 Halvt sæt 8x8mm, m/klipsroset cc 30/38mm, V

14.2416.02.920
 14.2416.02.930

Halvt sæt 9x9mm, m/klipsroset cc 38mm, H
 Halvt sæt 9x9mm, m/klipsroset cc 38mm, V

14.2436.02.920
 14.2436.02.930

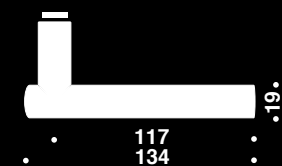

Halvt sæt 7x7mm, u/roset, H
 Halvt sæt 7x7mm, u/roset, V

14.2450.02.920
 14.2450.02.930

Halvt sæt 8x8mm, u/roset, H
 Halvt sæt 8x8mm, u/roset, V

14.2410.02.920
 14.2410.02.930

Halvt sæt 9x9mm, u/roset, H
 Halvt sæt 9x9mm, u/roset, V

14.2430.02.920
 14.2430.02.930



Dørgreb godkendt
 til branddøre i hen-
 hold til DIN 18273

Dørgreb FF form 19mm



Dørgreb FF form 19mm

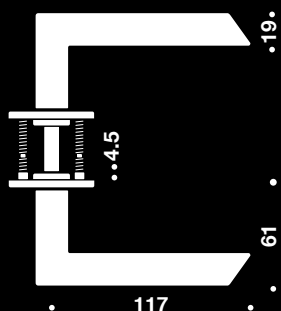

Beskrivelse

Sæt 7x7mm, m/klipsroset cc 30/38mm, 33-59mm

Sæt 7x7mm, m/klipsroset cc 30/38mm, 59-85mm

Sæt 8x8mm, m/massiv roset cc 30mm, 33-59mm

Sæt 8x8mm, m/massiv roset cc 30mm, 59-85mm

Sæt 8x8mm, m/massiv roset cc 38mm, 33-59mm

Sæt 8x8mm, m/massiv roset cc 38mm, 59-85mm

Sæt 8x8mm, m/klipsroset cc 30/38mm, 33-59mm

Sæt 8x8mm, m/klipsroset cc 30/38mm, 59-85mm

Sæt 9x9mm, m/klipsroset cc 38mm, 33-59mm

Sæt 9x9mm, m/klipsroset cc 38mm, 59-85mm

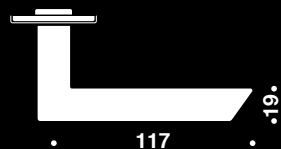

Halvt sæt 7x7mm, m/klipsroset cc 30/38mm

Halvt sæt 8x8mm, m/massiv roset cc 30mm

Halvt sæt 8x8mm, m/massiv roset cc 38mm

Halvt sæt 8x8mm, m/klipsroset cc 30/38mm

Halvt sæt 9x9mm, m/klipsroset cc 38mm



Halvt sæt 7x7mm, u/roset

Halvt sæt 8x8mm, u/roset

Halvt sæt 9x9mm, u/roset

Varenummer

14.2556.02.010

14.2556.02.020

14.2511.02.010

14.2511.02.020

14.2512.02.010

14.2512.02.020

14.2516.02.010

14.2516.02.020

14.2536.02.010

14.2536.02.020

14.2556.02.900

14.2511.02.900

14.2512.02.900

14.2516.02.900

14.2536.02.900

14.2550.02.900

14.2510.02.900

14.2530.02.900

EN1906:2010



Dørgreb godkendt til branddøre i henhold til DIN 18273

Dørgreb FFG form 19mm



Dørgreb FFG form 19mm

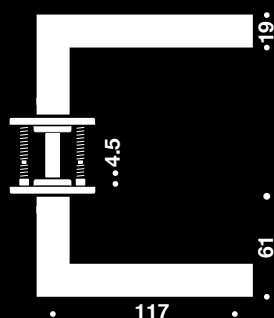

Beskrivelse

Sæt 7x7mm, m/klipsroset cc 30/38mm, 33-59mm

Sæt 7x7mm, m/klipsroset cc 30/38mm, 59-85mm

Sæt 8x8mm, m/massiv roset cc 30mm, 33-59mm

Sæt 8x8mm, m/massiv roset cc 30mm, 59-85mm

Sæt 8x8mm, m/massiv roset cc 38mm, 33-59mm

Sæt 8x8mm, m/massiv roset cc 38mm, 59-85mm

Sæt 8x8mm, m/klipsroset cc 30/38mm, 33-59mm

Sæt 8x8mm, m/klipsroset cc 30/38mm, 59-85mm

Sæt 9x9mm, m/klipsroset cc 38mm, 33-59mm

Sæt 9x9mm, m/klipsroset cc 38mm, 59-85mm

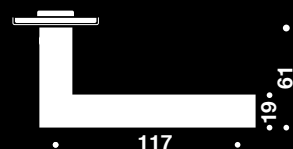

Halvt sæt 7x7mm, m/klipsroset cc 30/38mm

Halvt sæt 8x8mm, m/massiv roset cc 30mm

Halvt sæt 8x8mm, m/massiv roset cc 38mm

Halvt sæt 8x8mm, m/klipsroset cc 30/38mm

Halvt sæt 9x9mm, m/klipsroset cc 38mm



Halvt sæt 7x7mm, u/roset

Halvt sæt 8x8mm, u/roset

Halvt sæt 9x9mm, u/roset

Varenummer

14.0256.02.010

14.0256.02.020

14.0211.02.010

14.0211.02.020

14.0212.02.010

14.0212.02.020

14.0216.02.010

14.0216.02.020

14.0236.02.010

14.0236.02.020

14.0256.02.900

14.0211.02.900

14.0212.02.900

14.0216.02.900

14.0236.02.900

14.0250.02.900

14.0210.02.900

14.0230.02.900



Dørgreb godkendt til branddøre i henhold til DIN 18273

Dørgreb FFU form 19mm



Dørgreb FFU form 19mm

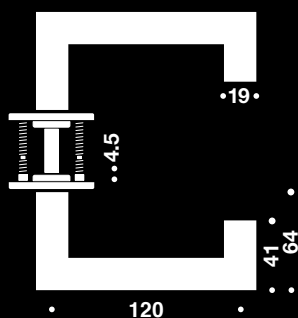

Beskrivelse

Sæt 7x7mm, m/klipsroset cc 30/38mm, 33-59mm

Sæt 7x7mm, m/klipsroset cc 30/38mm, 59-85mm

Sæt 8x8mm, m/massiv roset cc 30mm, 33-59mm

Sæt 8x8mm, m/massiv roset cc 30mm, 59-85mm

Sæt 8x8mm, m/massiv roset cc 38mm, 33-59mm

Sæt 8x8mm, m/massiv roset cc 38mm, 59-85mm

Sæt 8x8mm, m/klipsroset cc 30/38mm, 33-59mm

Sæt 8x8mm, m/klipsroset cc 30/38mm, 59-85mm

Sæt 7x7mm, w/F17S, 33-59mm

Sæt 7x7mm, w/F17S, 59-85mm

Sæt 8x8mm, w/F17S, 33-59mm

Sæt 8x8mm, w/F17S, 59-85mm

Varenummer

14.0356.02.010

14.0356.02.020

14.0311.02.010

14.0311.02.020

14.0312.02.010

14.0312.02.020

14.0316.02.010

14.0316.02.020

14.0358.02.010

14.0358.02.020

14.0318.02.010

14.0318.02.020

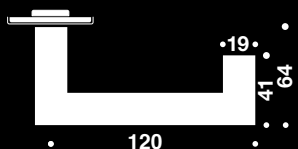

Halvt sæt 7x7mm, m/klipsroset cc 30/38mm

14.0356.02.900

Halvt sæt 8x8mm, m/massiv roset cc 30mm

14.0311.02.900

Halvt sæt 8x8mm, m/massiv roset cc 38mm

14.0312.02.900

Halvt sæt 8x8mm, m/klipsroset cc 30/38mm

14.0316.02.900

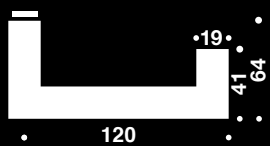

Halvt sæt 7x7mm, u/roset

14.0350.02.900

Halvt sæt 8x8mm, u/roset

14.0310.02.900



Dørgreb
godkendt
til DIN 179

Dørgreb O form 19mm



Dørgreb O form 19mm

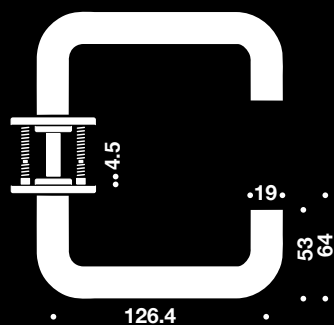

Beskrivelse

Sæt 7x7mm, m/klipsroset cc 30/38mm, 33-59mm

Sæt 7x7mm, m/klipsroset cc 30/38mm, 59-85mm

Sæt 8x8mm, m/massiv roset cc 30mm, 33-59mm

Sæt 8x8mm, m/massiv roset cc 30mm, 59-85mm

Sæt 8x8mm, m/massiv roset cc 38mm, 33-59mm

Sæt 8x8mm, m/massiv roset cc 38mm, 59-85mm

Sæt 8x8mm, m/klipsroset cc 30/38mm, 33-59mm

Sæt 8x8mm, m/klipsroset cc 30/38mm, 59-85mm

Varenummer

14.2756.02.010

14.2756.02.020

14.2711.02.010

14.2711.02.020

14.2712.02.010

14.2712.02.020

14.2716.02.010

14.2716.02.020



Halvt sæt 7x7mm, m/klipsroset cc 30/38mm, H

Halvt sæt 7x7mm, m/klipsroset cc 30/38mm, V

Halvt sæt 8x8mm, m/massiv roset cc 30mm, H

Halvt sæt 8x8mm, m/massiv roset cc 30mm, V

Halvt sæt 8x8mm, m/massiv roset cc 38mm, H

Halvt sæt 8x8mm, m/massiv roset cc 38mm, V

Halvt sæt 8x8mm, m/klipsroset cc 30/38mm, H

Halvt sæt 8x8mm, m/klipsroset cc 30/38mm, V

14.2756.02.920

14.2756.02.930

14.2711.02.920

14.2711.02.930

14.2712.02.920

14.2712.02.930

14.2716.02.920

14.2716.02.930



Halvt sæt 7x7mm, u/roset, H

Halvt sæt 7x7mm, u/roset, V

Halvt sæt 8x8mm, u/roset, H

Halvt sæt 8x8mm, u/roset, V

14.2750.02.920

14.2750.02.930

14.2710.02.920

14.2710.02.930



Dørgreb
godkendt
til DIN 179

Dørgreb L form 22mm



Dørgreb L form 22mm

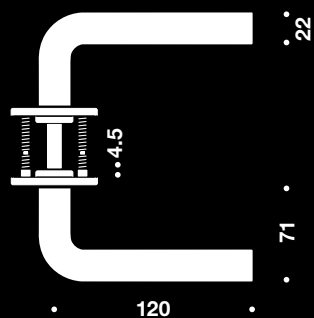

Beskrivelse

Sæt 7x7mm, m/klipsroset cc 30/38mm, 33-59mm
 Sæt 7x7mm, m/klipsroset cc 30/38mm, 59-85mm

Sæt 8x8mm, m/massiv roset cc 30mm, 33-59mm
 Sæt 8x8mm, m/massiv roset cc 30mm, 59-85mm

Sæt 8x8mm, m/massiv roset cc 38mm, 33-59mm
 Sæt 8x8mm, m/massiv roset cc 38mm, 59-85mm

Sæt 8x8mm, m/klipsroset cc 30/38mm, 33-59mm
 Sæt 8x8mm, m/klipsroset cc 30/38mm, 59-85mm

Sæt 9x9mm, m/klipsroset cc 38mm, 33-59mm M4
 Sæt 9x9mm, m/klipsroset cc 38mm, 59-85mm Ø4,5

Varenummer

14.0056.02.010
 14.0056.02.020

14.0011.02.010
 14.0011.02.020

14.0012.02.010
 14.0012.02.020

14.0016.02.010
 14.0016.02.020

14.0036.02.010
 14.0036.02.020

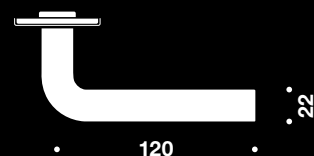

Halv sæt 7x7mm, m/klipsroset cc 30/38mm

14.0056.02.900

Halv sæt 8x8mm, m/massiv roset cc 30mm
 Halv sæt 8x8mm, m/massiv roset cc 38mm

14.0011.02.900
 14.0012.02.900

Halv sæt 8x8mm, m/klipsroset cc 30/38mm

14.0016.02.900

Halv sæt 9x9mm, m/klipsroset cc 38mm

14.0036.02.900

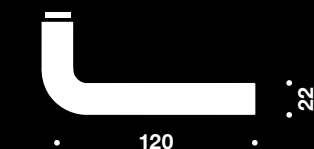

Halv sæt 7x7mm, u/roset

14.0050.02.900

Halv sæt 8x8mm, u/roset

14.0010.02.900

Halv sæt 9x9mm, u/roset

14.0030.02.900



Dørgreb godkendt
 til branddøre i hen-
 hold til DIN 18273

Dørgreb U form 22mm



Dørgreb U form 22mm

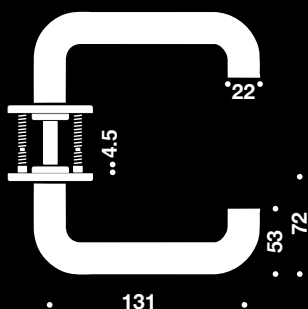

Beskrivelse

Sæt 7x7mm, m/klipsroset cc 30/38mm, 33-59mm
 Sæt 7x7mm, m/klipsroset cc 30/38mm, 59-85mm

Sæt 8x8mm, m/massiv roset cc 30mm, 33-59mm
 Sæt 8x8mm, m/massiv roset cc 30mm, 59-85mm

Sæt 8x8mm, m/massiv roset cc 38mm, 33-59mm
 Sæt 8x8mm, m/massiv roset cc 38mm, 59-85mm

Sæt 8x8mm, m/klipsroset cc 30/38mm, 33-59mm
 Sæt 8x8mm, m/klipsroset cc 30/38mm, 59-85mm

Sæt 9x9mm, m/klipsroset cc 38mm, 33-59mm
 Sæt 9x9mm, m/klipsroset cc 38mm, 59-85mm

Varenummer

14.0156.02.010
 14.0156.02.020

14.0111.02.010
 14.0111.02.020

14.0112.02.010
 14.0112.02.020

14.0116.02.010
 14.0116.02.020

14.0136.02.010
 14.0136.02.020

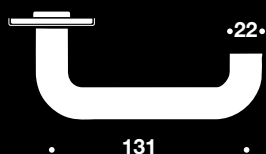

Halv sæt 7x7mm, m/klipsroset cc 30/38mm

14.0156.02.900

Halv sæt 8x8mm, m/massiv roset cc 30mm
 Halv sæt 8x8mm, m/massiv roset cc 38mm

14.0111.02.900
 14.0112.02.900

Halv sæt 8x8mm, m/klipsroset cc 30/38mm

14.0116.02.900

Halv sæt 9x9mm, m/klipsroset cc 38mm

14.0136.02.900



Halv sæt 7x7mm, u/roset

14.0150.02.900

Halv sæt 8x8mm, u/roset

14.0110.02.900

Halv sæt 9x9mm, u/roset

14.0130.02.900

EN1906:2010



Dørgreb godkendt
 til branddøre i hen-
 hold til DIN 18273

Dørgreb FK form forsat knop



Dørgreb FK form forsat knop

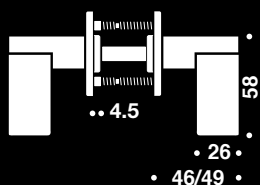

Beskrivelse

Sæt 7x7mm, m/klipsroset cc 30/38mm, 33-49mm

Sæt 7x7mm, m/klipsroset cc 30/38mm, 49-65mm

Sæt 8x8mm, m/massiv roset cc 30mm, 33-49mm

Sæt 8x8mm, m/massiv roset cc 30mm, 49-65mm

Sæt 8x8mm, m/massiv roset cc 38mm, 33-49mm

Sæt 8x8mm, m/massiv roset cc 38mm, 49-65mm

Sæt 8x8mm, m/klipsroset cc 30/38mm, 33-49mm

Sæt 8x8mm, m/klipsroset cc 30/38mm, 49-65mm

Sæt 9x9mm, m/klipsroset cc 38mm, 33-49mm

Sæt 9x9mm, m/klipsroset cc 38mm, 49-65mm

Varenummer

14.1756.02.010

14.1756.02.020

14.1711.02.010

14.1711.02.020

14.1712.02.010

14.1712.02.020

14.1716.02.018

14.1716.02.026

14.1736.02.010

14.1736.02.020

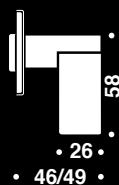

Halvt sæt 7x7mm, m/klipsroset cc 30/38mm

14.1756.02.900

Halvt sæt 8x8mm, m/massiv roset cc 30mm

14.1711.02.900

Halvt sæt 8x8mm, m/massiv roset cc 38mm

14.1712.02.900

Halvt sæt 8x8mm, m/klipsroset cc 30/38mm

14.1716.02.905

Halvt sæt fast funktion, u/roset, M6 (for montering på langskilt eller roset)

14.1710.02.800

Halvt sæt 9x9mm, m/klipsroset cc 38mm

14.1736.02.900

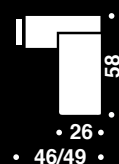

Halvt sæt 7x7mm, t/kuglelejerose

14.1750.02.900

Halvt sæt 8x8mm, t/kuglelejerose

14.1710.02.908

Halvt sæt 9x9mm, t/kuglelejerose

14.1730.02.908

Halvt sæt 7x7mm, t/langskilt

14.1750.02.700

Halvt sæt 8x8mm, t/langskilt

14.1710.02.700

Halvt sæt 9x9mm, t/langskilt

14.1730.02.700



Dørgreb godkendt til branddøre i henhold til DIN 18273

Dørgreb CK form cylindrisk knop

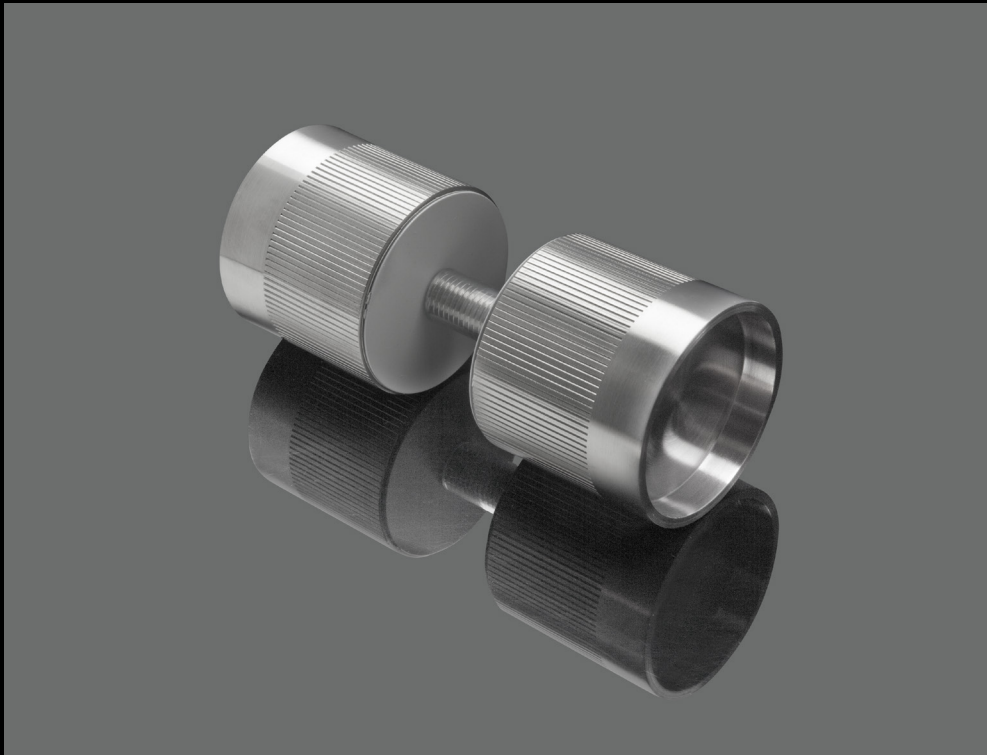

Dørgreb CK form cylindrisk knop

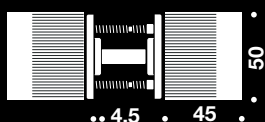

Beskrivelse

Sæt 7x7mm, m/klipsroset cc 30/38mm, 33-64mm

Sæt 7x7mm, m/klipsroset cc 30/38mm, 64-96mm

Sæt 8x8mm, m/massiv roset cc 30mm, 33-64mm

Sæt 8x8mm, m/massiv roset cc 30mm, 64-96mm

Sæt 8x8mm, m/massiv roset cc 38mm, 33-64mm

Sæt 8x8mm, m/massiv roset cc 38mm, 64-96mm

Sæt 8x8mm, m/klipsroset cc 30/38mm, 33-64mm

Sæt 8x8mm, m/klipsroset cc 30/38mm, 64-96mm

Varenummer

14.3056.02.010

14.3056.02.020

14.3011.02.010

14.3011.02.020

14.3012.02.010

14.3012.02.020

14.3016.02.010

14.3016.02.020

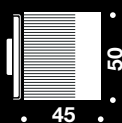

Halvt sæt fast funktion, u/roset, M6 (for montering på langskilt eller roset)

14.3010.02.800

Sæt for glasdør, inkl. M10 monteringsæt

14.3040.02.019

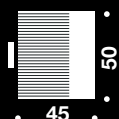

Halvt sæt 7x7mm, t/kuglelejerose

14.3050.02.908

Halvt sæt 8x8mm, t/kuglelejerose

14.3010.02.900

Halvt sæt 7x7mm, t/langskilt

14.3050.02.700

Halvt sæt 8x8mm, t/langskilt

14.3010.02.700

Dørgreb KK form rund knop



Dørgreb KK form rund knop

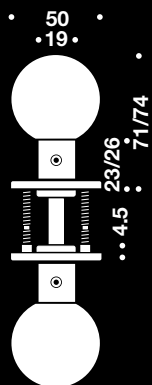

Beskrivelse

Sæt 7x7mm, m/klipsroset cc 30/38mm, 33-49mm
Sæt 7x7mm, m/klipsroset cc 30/38mm, 49-65mm

Varenummer

14.3156.02.010
14.3156.02.020

Sæt 8x8mm, m/massiv roset cc 30mm, 33-49mm
Sæt 8x8mm, m/massiv roset cc 30mm, 49-65mm

14.3111.02.010
14.3111.02.020

Sæt 8x8mm, m/massiv roset cc 38mm, 33-49mm
Sæt 8x8mm, m/massiv roset cc 38mm, 49-65mm

14.3112.02.010
14.3112.02.020

Sæt 8x8mm, m/klipsroset cc 30/38mm, 33-49mm
Sæt 8x8mm, m/klipsroset cc 30/38mm, 49-65mm

14.3116.02.013
14.3116.02.021

Sæt 9x9mm, m/klipsroset cc 38mm, 33-49mm
Sæt 9x9mm, m/klipsroset cc 38mm, 49-65mm

14.3136.02.010
14.3136.02.020

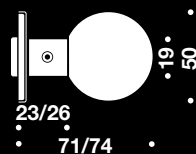

Halvt sæt 7x7mm, m/klipsroset cc 30/38mm

14.3156.02.900

Halvt sæt 8x8mm, m/massiv roset cc 30mm
Halvt sæt 8x8mm, m/massiv roset cc 38mm

14.3111.02.900
14.3112.02.900

Halvt sæt 8x8mm, m/klipsroset cc 30/38mm

14.3116.02.901

Halvt sæt fast funktion, u/roset, M6 (for montering på langskilt eller roset)

14.3110.02.800

Halvt sæt 9x9mm, m/klipsroset cc 38mm

14.3136.02.901

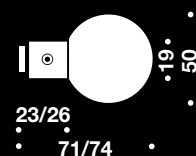

Halvt sæt 7x7mm, t/kuglelejerose

14.3150.02.900

Halvt sæt 8x8mm, t/kuglelejerose

14.3110.02.900

Halvt sæt 9x9mm, t/kuglelejerose

14.3130.02.900

Halvt sæt 7x7mm, t/langskilt

14.3150.02.700

Halvt sæt 8x8mm, t/langskilt

14.3110.02.700

Halvt sæt 9x9mm, t/langskilt

14.3130.02.700



Dørgreb godkendt
til branddøre i hen-
hold til DIN 18273

Ø130mm knop



Ø130mm knop

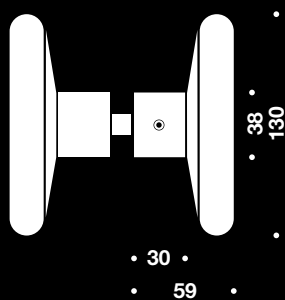

Beskrivelse

Sæt til glasdør, u/roset, 0-38mm, inkl. monteringssæt

Varenummer

14.3000.02.010

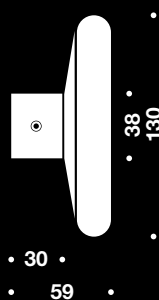

Halvt sæt m/bøsning til trædør

14.3000.02.900

EN1906:2010



CLASS 4

Dørgreb forlænger

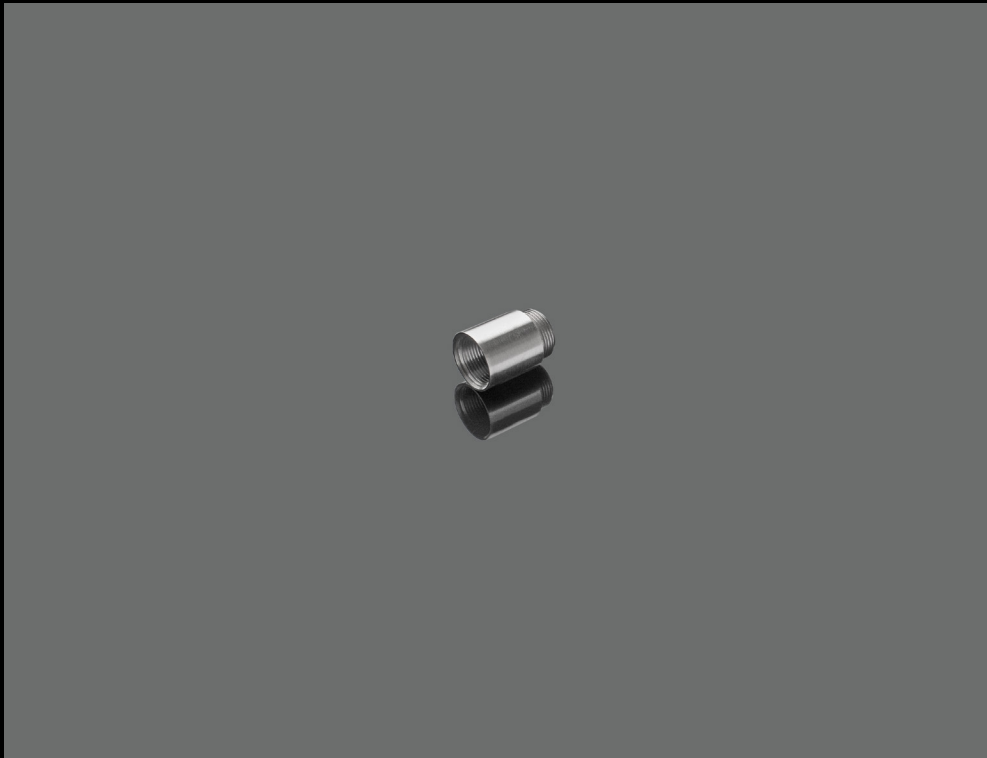

Dørgreb forlænger

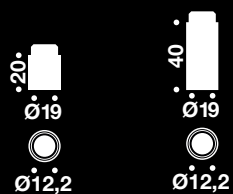

Beskrivelse

Halsforlænger, Ø19x20mm

Halsforlænger, Ø19x40mm

Varenummer

14.2900.02.020

14.2900.02.040

Standard og delte dørgrebspinde

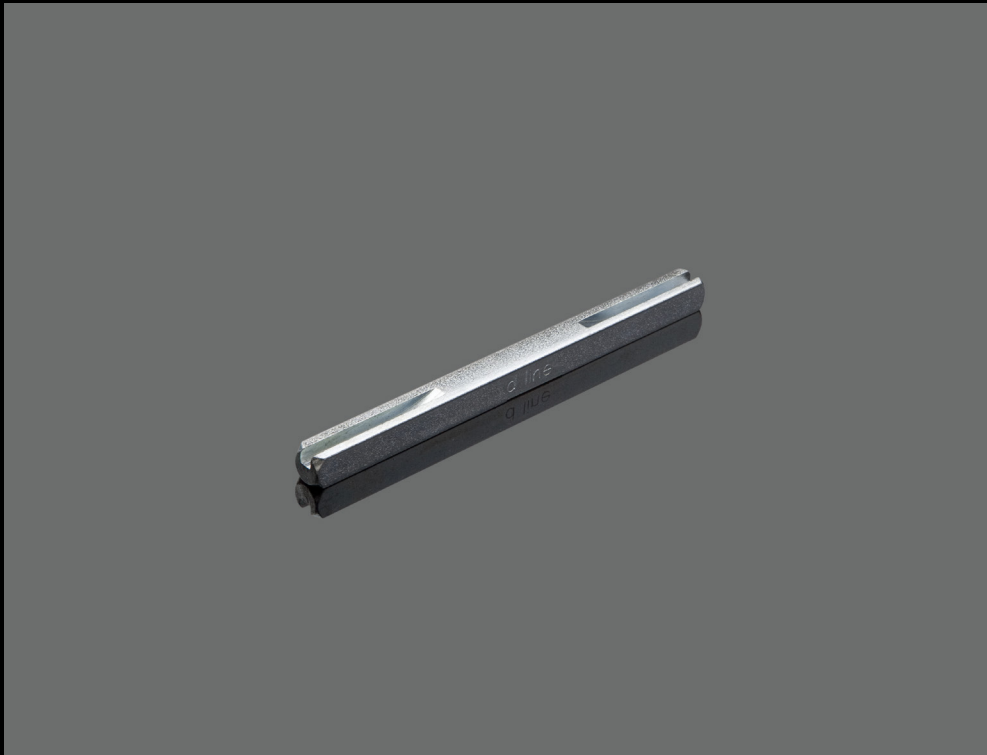

Dørgrebspinde 7x7mm og 8x8mm



7

Beskrivelse

7x7mm, for dørgrebstype L-U-C-B-FF, 33-59mm, 7x7x92mm
 7x7mm, for dørgrebstype L-U-C-B-FF, 59-85mm, 7x7x116mm
 7x7mm, for dørgrebstype L-U-C-B-FF, 85-111mm, 7x7x140mm

Varenummer

14.2850.92.092
 14.2850.92.116
 14.2850.92.140

7x7mm, for dørgrebstype M, 33-44mm, 7x7x76mm
 7x7mm, for dørgrebstype M, 44-60mm, 7x7x92mm
 7x7mm, for dørgrebstype M, 60-76mm, 7x7x108mm
 7x7mm, for dørgrebstype M, 76-92mm, 7x7x124mm
 7x7mm, for dørgrebstype M, 92-108mm, 7x7x140mm

14.2850.92.076
 14.2850.92.092
 14.2850.92.108
 14.2850.92.124
 14.2850.92.140

7x7mm, for knoptype CK, 33-64mm, 7x7x108mm
 7x7mm, for knoptype CK, 64-96mm, 7x7x140mm

14.2850.92.108
 14.2850.92.140

7x7mm, for knoptype FK-KK, 33-49mm, 7x7x92mm
 7x7mm, for knoptype FK-KK, 49-65mm, 7x7x108mm
 7x7mm, for knoptype FK-KK, 65-81mm, 7x7x124mm
 7x7mm, for knoptype FK-KK, 81-97mm, 7x7x140mm

14.2850.92.092
 14.2850.92.108
 14.2850.92.124
 14.2850.92.140

7x7mm, for dørgrebstype LF-UF, 33-44mm, 7x7x76mm
 7x7mm, for dørgrebstype LF-UF, 44-52mm, 7x7x84mm
 7x7mm, for dørgrebstype LF-UF, 52-60mm, 7x7x92mm
 7x7mm, for dørgrebstype LF-UF, 60-68mm, 7x7x100mm
 7x7mm, for dørgrebstype LF-UF, 68-76mm, 7x7x108mm

14.2850.92.076
 14.2850.92.084
 14.2850.92.092
 14.2850.92.100
 14.2850.92.108



8

Beskrivelse

8x8mm, for dørgrebstype L-U-C-B-FF, 33-59mm, 8x8x92mm
 8x8mm, for dørgrebstype L-U-C-B-FF, 59-85mm, 8x8x116mm
 8x8mm, for dørgrebstype L-U-C-B-FF, 85-111mm, 8x8x140mm

Varenummer

14.2810.92.092
 14.2810.92.116
 14.2810.92.140

8x8mm, for dørgrebstype M, 33-44mm, 8x8x76mm
 8x8mm, for dørgrebstype M, 44-60mm, 8x8x92mm
 8x8mm, for dørgrebstype M, 60-76mm, 8x8x108mm
 8x8mm, for dørgrebstype M, 76-92mm, 8x8x124mm
 8x8mm, for dørgrebstype M, 92-108mm, 8x8x140mm

14.2810.92.076
 14.2810.92.092
 14.2810.92.108
 14.2810.92.124
 14.2810.92.140

8x8mm, for knoptype CK, 33-64mm, 8x8x108mm
 8x8mm, for knoptype CK, 64-96mm, 8x8x140mm

14.2810.92.108
 14.2810.92.140

8x8mm, for knoptype FK-KK, 33-49mm, 8x8x92mm
 8x8mm, for knoptype FK-KK, 49-65mm, 8x8x108mm
 8x8mm, for knoptype FK-KK, 65-81mm, 8x8x124mm
 8x8mm, for knoptype FK-KK, 81-97mm, 8x8x140mm

14.2810.92.092
 14.2810.92.108
 14.2810.92.124
 14.2810.92.140

8x8mm, for dørgrebstype LF-UF, 33-44mm, 8x8x76mm
 8x8mm, for dørgrebstype LF-UF, 44-52mm, 8x8x84mm
 8x8mm, for dørgrebstype LF-UF, 52-60mm, 8x8x92mm
 8x8mm, for dørgrebstype LF-UF, 60-68mm, 8x8x100mm
 8x8mm, for dørgrebstype LF-UF, 68-76mm, 8x8x108mm

14.2810.92.076
 14.2810.92.084
 14.2810.92.092
 14.2810.92.100
 14.2810.92.108

Dørgrebspind t/fast montering m/hank



Beskrivelse

8x8mm, M8, 85mm

8x8mm, M8, 145mm

Varenummer

14.2830.92.801

14.2830.92.115

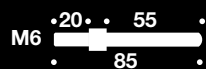

8x8mm, M6, 85mm

8x8mm, M6, 145mm

14.2840.92.801

14.2840.92.802



Dørgrebspind 9x9mm



Beskrivelse

9x9mm, for dørgrebstype L-U-C-B-FF, 33-59mm, 9x9x92mm
 9x9mm, for dørgrebstype L-U-C-B-FF, 59-85mm, 9x9x116mm
 9x9mm, for dørgrebstype L-U-C-B-FF, 85-111mm, 9x9x140mm

Varenummer

14.2830.92.092
 14.2830.92.116
 14.2830.92.140

9x9mm, for knoptype FK-KK, 33-49mm, 9x9x92mm
 9x9mm, for knoptype FK-KK, 49-65mm, 9x9x108mm
 9x9mm, for knoptype FK-KK, 65-81mm, 9x9x124mm
 9x9mm, for knoptype FK-KK, 81-97mm, 9x9x140mm

14.2830.92.092
 14.2830.92.108
 14.2830.92.124
 14.2830.92.140

9x9mm, for dørgrebstype LF-UF, 33-44mm, 9x9x76mm
 9x9mm, for dørgrebstype LF-UF, 44-52mm, 9x9x84mm
 9x9mm, for dørgrebstype LF-UF, 52-60mm, 9x9x92mm
 9x9mm, for dørgrebstype LF-UF, 60-68mm, 9x9x100mm
 9x9mm, for dørgrebstype LF-UF, 68-76mm, 9x9x108mm

14.2830.92.076
 14.2830.92.084
 14.2830.92.092
 14.2830.92.100
 14.2830.92.108

Delt dørgrebspind



Beskrivelse

8x8x92mm, for dørgrebstype L-U-C-B-FF, 33-59mm
 8x8x116mm, for dørgrebstype L-U-C-B-FF, 59-85mm
 8x8x140mm, for dørgrebstype L-U-C-B-FF, 85-111mm

Varenummer

14.2811.92.801
 14.2811.92.802
 14.2811.92.803



9x9x92mm, for dørgrebstype L-U-C-B-FF, 33-59mm
 9x9x116mm, for dørgrebstype L-U-C-B-FF, 59-85mm
 9x9x140mm, for dørgrebstype L-U-C-B-FF, 85-111mm

14.2811.92.901
 14.2811.92.902
 14.2811.92.903

Dørgrebspinde t/ensidig montage



Envejs dørgrebspind

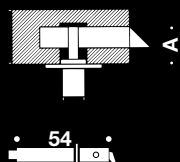

Beskrivelse

8x8x54mm, A=30-39mm

8x8x63mm, A=39-48mm

8x8x70mm, A=36-45mm

9x9x60mm, A=36-45mm

9x9x65mm, A=41-50mm

9x9x70mm, A=46-55mm

Varenummer

14.2800.92.801

14.2800.92.802

14.2800.92.803

14.2800.92.901

14.2800.92.902

14.2800.92.903

Ensidig dørgrebspind

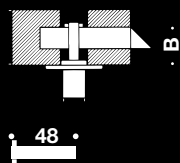

Beskrivelse

8x8x48mm, B=20-29mm

8x8x55mm, B=27-36mm

Varenummer

14.2805.92.801

14.2805.92.802

Ensidig dørgrebspind t/låsekasse m/delt grebsfunktion

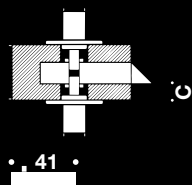

Beskrivelse

8x8x41mm, C=8-17

9x9x41mm, C=8-17

9x9x50mm, C=17-26

9x9x59mm, C=26-35

9x9x68mm, C=35-44

Varenummer

14.2810.92.801

14.2810.92.901

14.2810.92.902

14.2810.92.903

14.2810.92.904

Værktøj



Værktøj



Beskrivelse
Klipsaftrækker

Varenummer
14.2930.02.002



Torx værktøjssæt, TX10, skruetrækker og bit

14.9767.00.105

Torx skruetrækker TX10

14.9768.10.008

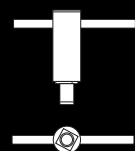

T/montering af kuglelejesætning

14.2935.00.089



T/montering af grisetrynebolt M8

14.4971.92.006

T/montering af grisetrynebolt M10/M12

14.4972.92.001



Boreværktøjer



Boreværktøjer



Beskrivelse

Ø42mm, t/returfjeder, t/forborede døre, Ø20-40mm

Varenummer

14.2924.00.005



Ø32mm styret 8mm bor t/forborede døre Ø25-32mm

14.2926.00.004

Ø25mm styret 8mm bor t/forborede trædøre Ø9-25mm

14.2928.00.003



T/styrebrikker, t/forborede trædøre, Ø40mm, CC30mm, afstand 7-20mm

14.2925.00.107

T/styrebrikker, t/forborede trædøre, Ø40mm, CC30mm, afstand 20-40mm

14.2925.00.204



T/udboring af Ø40mm hul t/monteringsplade CC30mm

14.3455.00.007







Ø25mm, t/forborede ståldøre, Ø9-25mm

14.2929.00.008

Skruer



Skruer

	Beskrivelse	Varenummer
 <p>• M4 • TX10</p>	Bøsningsskrue TX10 m/bøsning, M4x39mm (u/knæk)	14.2961.74.030
	Bøsningsskrue TX10 m/bøsning, M4x100mm	14.2961.74.107
	Bøsningsskrue TX10, M4x39mm (u/knæk)	14.9704.74.040
	Bøsningsskrue TX10, M4x100mm	14.9704.74.065
	M4x12mm bøsning	14.9704.74.018
	M4 skruer benyttet til montering af rosetter og langskilte	
 <p>• M5 • TX10</p>	Bøsningsskrue TX10 m/bøsning, M5x75mm	14.2962.74.071
	Bøsningsskrue TX10 m/bøsning, M5x100mm	14.2962.74.101
	Bøsningsskrue TX10, M5x75mm	14.2981.74.750
	Bøsningsskrue TX10, M5x100mm	14.2981.74.990
	M5x12mm bøsning	14.9704.74.031
	M5 skruer benyttet til montering af cylinderringe og sikkerheds langskilte	
 <p>• TX10</p>	Selvskærende skrue 3,5x10mm	14.2951.02.102
	Selvskærende skrue 3,5x16mm	14.2951.02.161
	Selvskærende skrue 4,2x10mm	14.2951.02.200
	Selvskærende skrue 4,2x16mm	14.2951.02.260
	Pinolskrue t/Ø16mm dørgreb, M5x6,8mm	14.9701.02.016
	Pinolskrue t/Ø19mm dørgreb, M5x8,3mm	14.9701.02.019

Returfjedre og styrebrikker



Returfjedre og styrebrikker



Beskrivelse

Styrebrik 4,5mm t/skruemontering, CC30mm

Varenummer

14.2986.00.006



Styrebrik t/kugleleje Ø25mm

14.2990.00.002

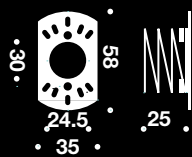

Styrebrik t/ståldøre tykkelse >60mm, CC30mm, m/skruer M4x10mm

14.2988.00.005

Styrebrik t/ståldøre tykkelse <60mm, CC30mm, m/skruer M4x10mm

14.2988.00.609



Enkelt-sided returfjeder, CC38mm

14.2993.00.014



Dobbelt-sided returfjeder, CC38mm

14.2992.00.028

Rosetter m/kugleleje

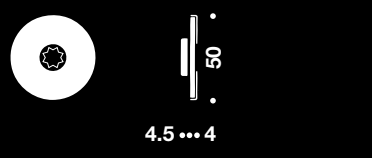
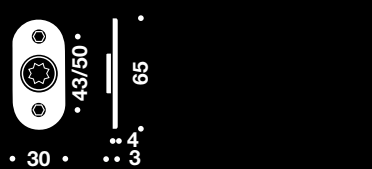

Rosetter m/kugleleje

	Beskrivelse	Varenummer
 <p>•30/38• 4.5 ... 3</p>	<p>T/dørgreb, massiv cc 30mm T/dørgreb, massiv cc 38mm</p>	<p>14.3210.02.154 14.3210.02.201</p>
 <p>•30/38• 4.5 ... 4</p>	<p>T/14mm dørgreb, m/klipsroset cc 30/38mm T/16mm dørgreb, m/klipsroset cc 30/38mm T/19mm dørgreb, m/klipsroset cc 30/38mm</p>	<p>14.3216.02.600 14.3216.02.607 14.3216.02.909</p>
 <p>•43/50• • 30 • 3.4 65</p>	<p>T/14mm dørgreb, m/klipsroset cc 43mm T/16mm dørgreb, m/klipsroset cc 43mm T/19mm dørgreb, m/klipsroset cc 43mm</p>	<p>14.3217.02.336 14.3217.02.369 14.3217.02.393</p>
 <p>•43/50• • 30 • 4.5 65</p>	<p>T/14mm dørgreb, m/klipsroset cc 50mm T/16mm dørgreb, m/klipsroset cc 50mm T/19mm dørgreb, m/klipsroset cc 50mm</p> <p>T/dørgreb, massiv cc 43mm T/dørgreb, massiv cc 50mm</p>	<p>14.3217.02.433 14.3217.02.466 14.3217.02.491 14.3211.02.443 14.3211.02.450</p>

Rosetter t/fast dørgræb/knopper



Rosetter t/fast dørgreb/knopper



Beskrivelse

M/hul t/fast knopmontering, m/M4 bøsninger, m/klipsroset cc 38mm

M/hul t/fast knopmontering, m/klipsroset cc 30/38mm

M/hul t/fast knopmontering Ø50mm, m/fast klipsroset m/fast dørgrebspind cc 30mm

M/hul t/fast knopmontering Ø50mm, m/fast klipsroset m/fast dørgrebspind, cc 38mm

8x8mm dørgrebspind, m/klipsroset cc 30/38mm

Varenummer

14.3258.02.381

14.3258.02.900

14.3258.02.100

14.3257.02.420

14.3259.02.900

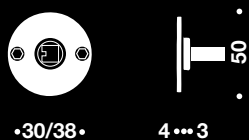

8x8mm dørgrebspind, massiv cc 30mm, V

8x8mm dørgrebspind, massiv cc 30mm, H

8x8mm dørgrebspind, massiv cc 38mm

14.3259.02.101

14.3259.02.102

14.3259.02.203

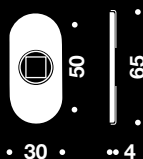

M/hul t/fast knopmontering, m/klipsroset cc 50mm

14.3257.02.900

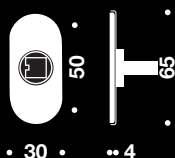

8x8mm dørgrebspind, m/klipsroset cc 50mm

14.3267.02.900

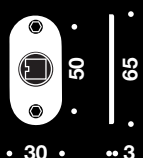

M/hul t/fast knopmontering, massiv cc 50mm

14.3257.02.400

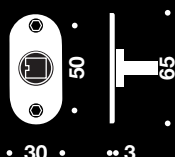

8x8mm dørgrebspind, massiv cc 50mm

14.3267.02.400

Nøgle- og blindskilte



Nøgle- og blindskilte



Beskrivelse
Nøgleskilt m/klipsroset cc 27/30/38mm

Varenummer
14.3235.02.804



Nøgleskilt m/massiv roset cc 27mm
Nøgleskilt m/massiv roset cc 30 mm
Nøgleskilt m/massiv roset cc 38mm

14.3230.02.551
14.3230.02.100
14.3230.02.208



Blindskilt m/klipsroset cc 27/30/38mm, hul M4
Blindskilt m/klipsroset cc 30mm, t/cylinderbesætning hul M5

14.3245.02.808
14.3465.02.100

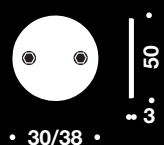

Blindskilt m/massiv roset cc 30mm
Blindskilt m/massiv roset cc 38mm, hul M4
Blindskilt m/massiv roset cc 30mm, t/cylinderbesætning hul M5

14.3240.02.104
14.3240.02.201
14.3460.02.108



Islåningsbøsning Ø16mm

14.3250.02.001

Oval 30x65mm nøgle- og blindskilte



Oval 30x65mm nøgle- og blindskilte

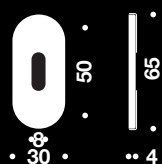

Beskrivelse
Nøgleskilt m/klipsroset cc 50mm

Varenummer
14.3237.02.401

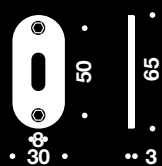

Nøgleskilt m/massiv roset cc 50mm

14.3234.02.400



Blindskilt m/klipsroset cc 43mm
Blindskilt m/klipsroset cc 50mm

14.3247.02.300
14.3247.02.408

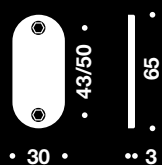

Blindskilt m/massiv roset cc 43mm
Blindskilt m/massiv roset cc 50mm

14.3241.02.300
14.3241.02.350

Ø50mm cylinderringe t/oval cylinder ASSA

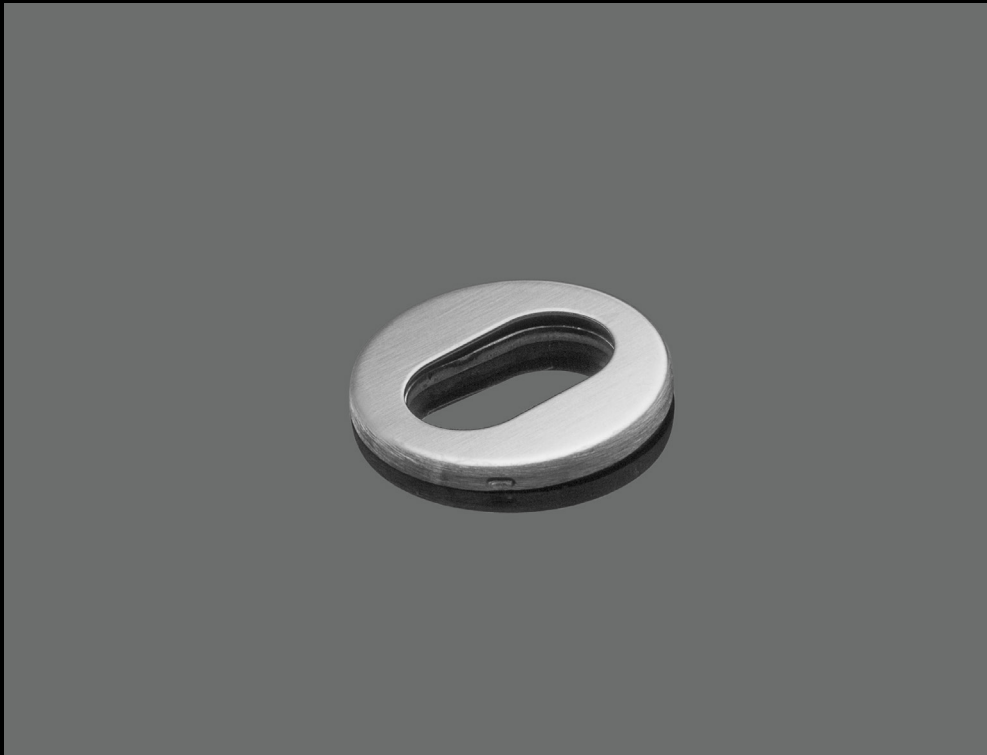

Ø50mm cylinderringe t/oval cylinder ASSA

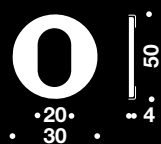

Beskrivelse

M/klipsroset cc 30mm

Varenummer

14.3436.02.139

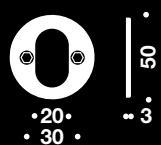

Massiv cc 30mm

14.3432.02.149

Ø50mm cylinderringe PZ



Ø50mm cylinderringe PZ

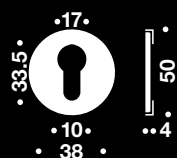

Beskrivelse
M/klipsroset cc 38mm

Varenummer
14.3435.02.215

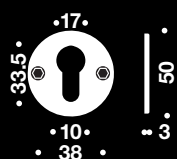

Massiv cc 38mm

14.3430.02.212

Ø50mm cylinderringe UNION



Ø50mm cylinderringe UNION

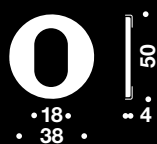

Beskrivelse
M/klipsroset cc 38mm

Varenummer
14.3435.02.223

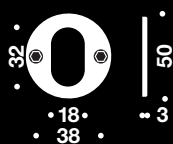

Massiv cc 38mm

14.3430.02.221

Ø50mm cylinderringe KESO/KABA

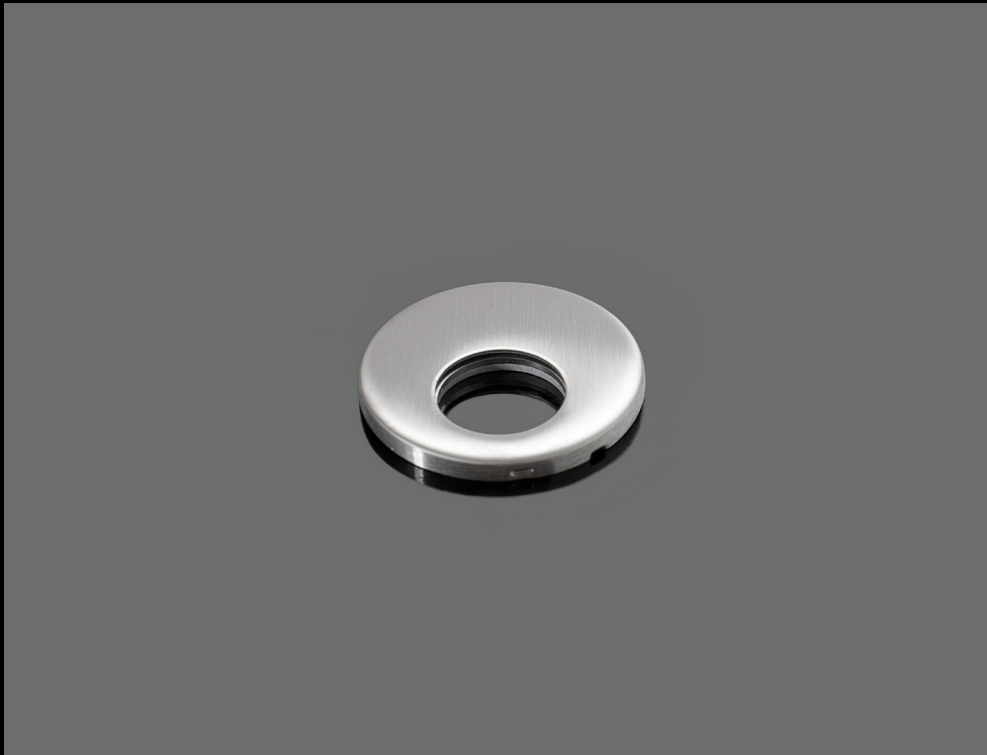

Ø50mm cylinderringe KESO/KABA

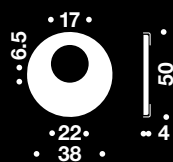

Beskrivelse
M/klipsroset cc 38mm

Varenummer
14.3435.02.258

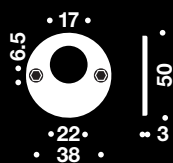

Massiv cc 38mm

14.3430.02.255

Cylinderringe



Cylinderringe

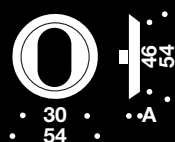

Beskrivelse

T/oval cylinder, 6mm udvendig
 T/oval cylinder, 8mm udvendig
 T/oval cylinder, 11mm udvendig
 T/oval cylinder, 13mm udvendig
 T/oval cylinder, 16mm udvendig
 T/oval cylinder, 18mm udvendig
 T/oval cylinder, 21mm udvendig

Varenummer

14.3441.02.067
 14.3441.02.083
 14.3441.02.113
 14.3441.02.130
 14.3441.02.164
 14.3441.02.181
 14.3441.02.211

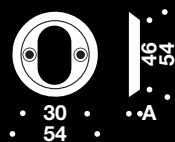

T/oval cylinder, 6mm indvendig
 T/oval cylinder, 8mm indvendig
 T/oval cylinder, 11mm indvendig
 T/oval cylinder, 13mm indvendig
 T/oval cylinder, 16mm indvendig
 T/oval cylinder, 18mm indvendig
 T/oval cylinder, 21mm indvendig

14.3451.02.061
 14.3451.02.087
 14.3451.02.117
 14.3451.02.168
 14.3451.02.184
 14.3451.02.213
 14.3451.02.214

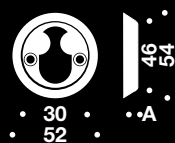

T/oval cylinder rokoko, 6mm indvendig
 T/oval cylinder rokoko, 8mm indvendig
 T/oval cylinder rokoko, 11mm indvendig
 T/oval cylinder rokoko, 13mm indvendig
 T/oval cylinder rokoko, 16mm indvendig
 T/oval cylinder rokoko, 18mm indvendig
 T/oval cylinder rokoko, 21mm indvendig

14.3453.02.060
 14.3453.02.086
 14.3453.02.116
 14.3453.02.132
 14.3453.02.167
 14.3453.02.167
 14.3453.02.183

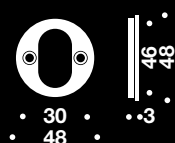

Underlagsroset t/langskilt
 Se boreværktøjer for boreværktøj

14.9710.00.067

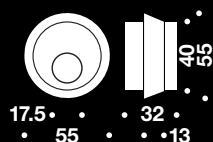

Sikkerhedscylinder, 13mm, t/oval cylinder

14.3438.02.130

Ø54mm cylinderringe PZ



Ø54mm cylinderringe PZ

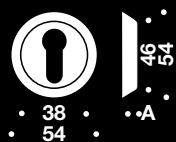

Beskrivelse

PZ, 6mm udvendig
PZ, 8mm udvendig
PZ, 11mm udvendig
PZ, 13mm udvendig
PZ, 16mm udvendig
PZ, 18mm udvendig

Varenummer

14.3444.02.061
14.3444.02.087
14.3444.02.117
14.3444.02.133
14.3444.02.168
14.3444.02.184

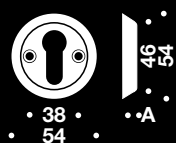

PZ, 6mm indvendig
PZ, 8mm indvendig

14.3454.02.064
14.3454.02.081

Oval 30x65mm cylinderringe PZ



Oval 30x65mm cylinderringe PZ



Beskrivelse
M/klipsroset cc 50mm

Varenummer
14.3437.02.419

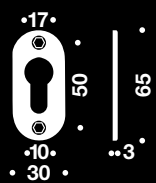

Massiv cc 50mm

14.3430.02.410

Oval 30x65mm cylinderringe ASSA



Oval 30x65mm cylinderringe ASSA

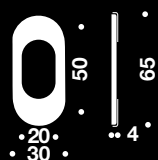

Beskrivelse

M/klipsroset cc 50mm

Varenummer

14.3437.02.440

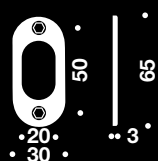

Massiv cc 50mm

14.3430.02.440

Oval 30x65mm cylinderringe KESO/KABA



Oval 30x65mm cylinderringe KESO/KABA

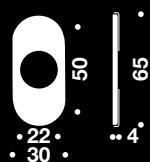

Beskrivelse

M/klipsroset cc 50mm

Varenummer

14.3437.02.450

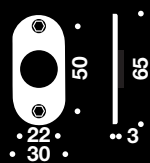











Massiv cc 50mm

14.3430.02.450

Vridergreb

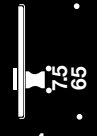

Vridergreb

		Beskrivelse	Varenummer
		M/klipsroset, cc 30mm, m/pind t/oval cylinder t/ASSA og Boda	14.3416.02.160
• 30 •	•• 4 • • 18 •	M/klipsroset, cc 38mm, m/pind 8x8mm	14.3416.02.280
		M/klipsroset, cc 38mm, m/pind 6x6mm	14.3416.02.500
• 38 •	•• 4 • • 18 •		
		Massiv, cc 30mm, m/pind t/oval cylinder t/ASSA og Boda	14.3410.02.169
•• 5.5 • • 30 •	•• 3 • • 18 •	Massiv, cc 38mm, m/pind 8x8mm	14.3410.02.282
		Massiv, cc 38mm, m/pind 6x6mm	14.3410.02.260
• 38 •	•• 3 • • 18 •		
		M/klipsroset, cc 50 mm, m/pind t/oval cylinder	14.3417.02.460
• 30 •	•• 4 •		
		Massiv, cc 50 mm, m/pind t/oval cylinder	14.3413.02.460
• 30 •	•• 3 •		

Ø50mm vridergreb – handicap



Ø50mm vridergreb – handicap



Beskrivelse

M/klipsroset, cc 30mm, m/pind t/oval cylinder, H

M/klipsroset, cc 30mm, m/pind t/oval cylinder, V

M/klipsroset, cc 38mm, m/pind 8x8mm

M/klipsroset, cc 38mm, m/pind 6x6mm

Varenummer

14.3418.02.150

14.3418.02.160

14.3418.02.280

14.3418.02.500

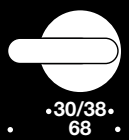

Massiv, cc 30mm, m/pind t/oval cylinder, H

Massiv, cc 30mm, m/pind t/oval cylinder, V

Massiv, cc 38mm, m/pind 8x8mm

Massiv, cc 38mm, m/pind 6x6mm

14.3411.02.163

14.3411.02.171

14.3411.02.287

14.3411.02.260

Nødudgangsbesætning

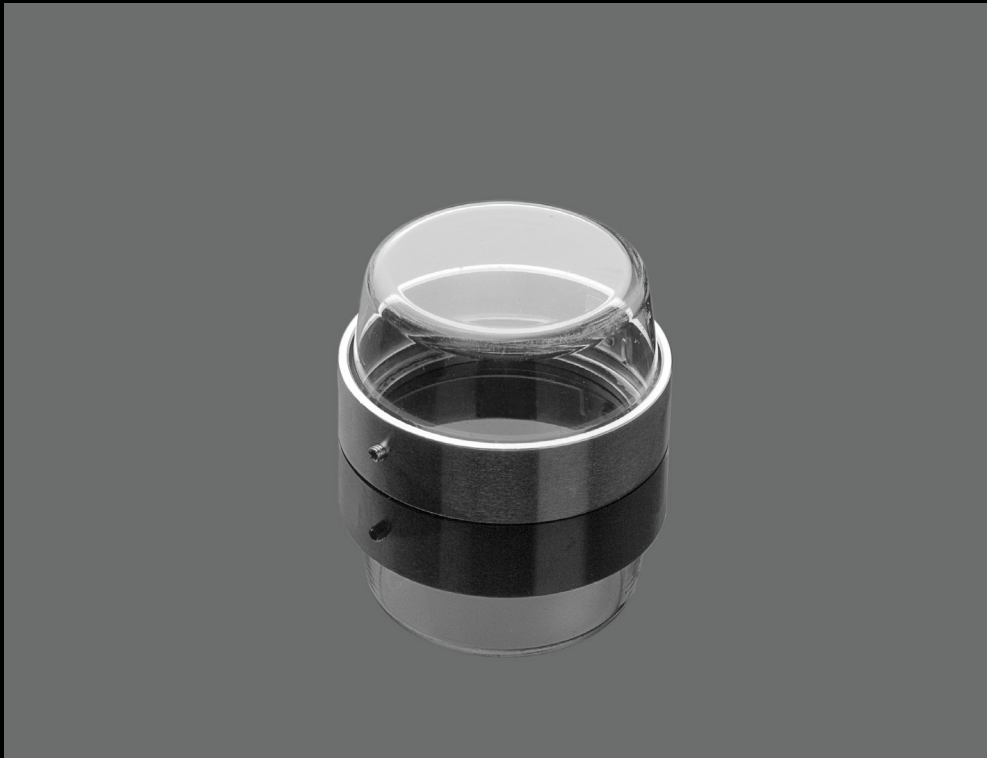

Nødudgangsbesætning

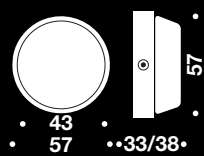

Beskrivelse

Inkl. glaskappe t/oval cylinder

Varenummer

14.3420.74.007

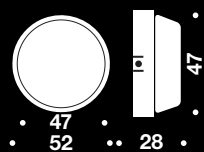

Inkl. glaskappe t/TrioVing

14.3421.74.000

Glaskappe t/14.3421 og 14.3420

14.3420.00.003

Ø50mm toiletbesætninger



Ø50mm toiletbesætninger

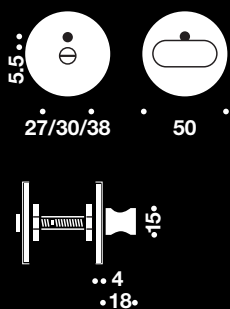

Beskrivelse

M/klipsroset, cc 27mm, 5mm pind og 180°, 34-48mm
 M/klipsroset, cc 30mm, 5mm pind og 90°, 34-48mm
 M/klipsroset, cc 38mm, 8mm pind og 90°, 34-48mm
 M/klipsroset, cc 38mm, 5mm pind og 90°, 34-48mm
 M/klipsroset, cc 38mm, 6mm pind og 90°, 34-48mm

Varenummer

14.3475.02.104
 14.3475.02.155
 14.3475.02.309
 14.3475.02.457
 14.3475.02.503

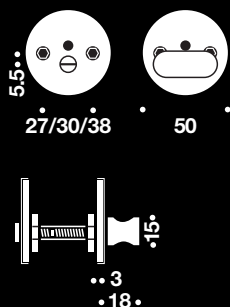

Massiv, cc 27mm, 5mm pind og 180°, 34-48mm
 Massiv, cc 30mm, 5mm pind og 90°, 34-48mm
 Massiv, cc 38mm, 8mm pind og 90°, 34-48mm
 Massiv, cc 38mm, 5mm pind og 90°, 34-48mm
 Massiv, cc 38mm, 6mm pind og 90°, 34-48mm

14.3470.02.101
 14.3470.02.152
 14.3470.02.306
 14.3470.02.454
 14.3470.02.501

Ø50mm toiletbesætninger – handicap



Ø50mm toiletbesætninger – handicap

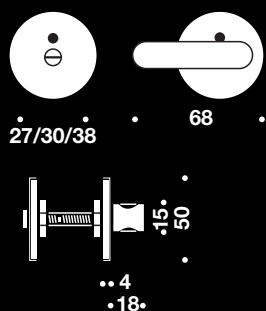

Beskrivelse

M/klipsroset, cc 27mm, 5mm pind og 180°, 34-48mm
 M/klipsroset, cc 30mm, 5mm pind og 90°, 34-48mm, H
 M/klipsroset, cc 30mm, 5mm pind og 90°, 34-48mm, V
 M/klipsroset, cc 38mm, 8mm pind og 90°, 34-48mm
 M/klipsroset, cc 38mm, 5mm pind og 90°, 34-48mm
 M/klipsroset, cc 38mm, 6mm pind og 90°, 34-48mm

Varenummer

14.3478.02.102
 14.3478.02.150
 14.3478.02.160
 14.3478.02.300
 14.3478.02.450
 14.3478.02.500

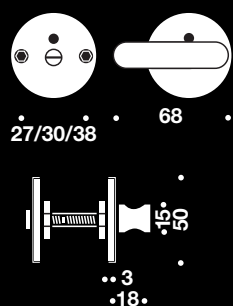

Massiv, cc 27mm, 5mm pind og 180°, 34-48mm
 Massiv, cc 30mm, 5mm pind og 90°, 34-48mm, H
 Massiv, cc 30mm, 5mm pind og 90°, 34-48mm, V
 Massiv, cc 38mm, 8mm pind og 90°, 34-48mm
 Massiv, cc 38mm, 5mm pind og 90°, 34-48mm
 Massiv, cc 38mm, 6mm pind og 90°, 34-48mm

14.3471.02.103
 14.3471.02.157
 14.3471.02.165
 14.3471.02.335
 14.3471.02.450
 14.3471.02.500

Udenpåliggende toiletbesætninger



Udenpåliggende toiletbesætninger

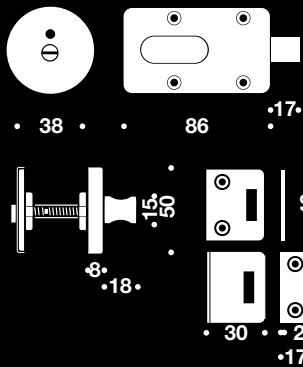

Beskrivelse

cc 38mm, 5mm pind, 18-34mm
cc 38mm, 5mm pind, 8-24mm

Varenummer

14.3476.02.028
14.3476.02.010

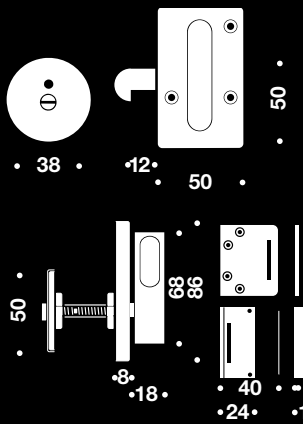

Hagelås-handicap, cc 38mm, 5mm pind, 26-42mm, H
Hagelås-handicap, cc 38mm, 5mm pind, 26-42mm, V

14.3479.02.021
14.3479.02.030

Toiletbesætning i skydedørsskål



Toiletbesætning i skydedørsskål



Beskrivelse

Toiletbesætning i skydedørsskål Ø50 5L90 t/oval cylinder

Toiletbesætning i skydedørsskål Ø50 6V90

Toiletbesætning i skydedørsskål Ø50 8L90

Varenummer

14.3974.02.095

14.3974.02.096

14.3974.02.098

Skydedørsskål rund

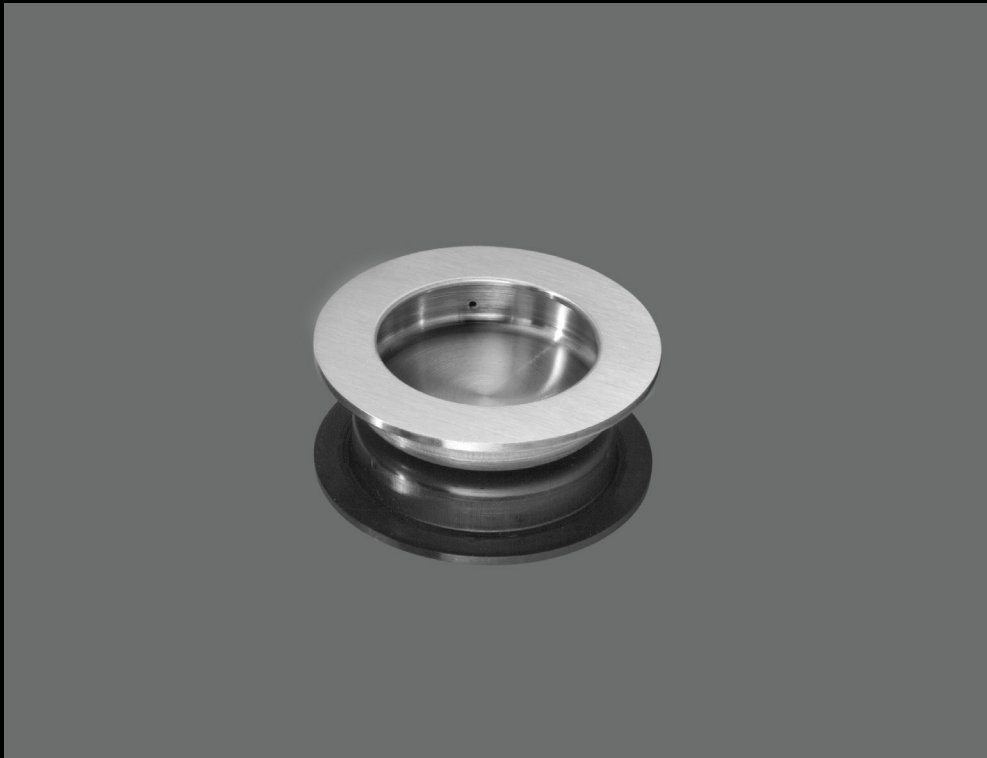

Skydedørsskål rund



Beskrivelse

Skålgreb Ø50mm

Skålgreb Ø80mm

Skålgreb Ø115mm

Varenummer

14.3900.02.051

14.3900.02.077

14.3900.02.115

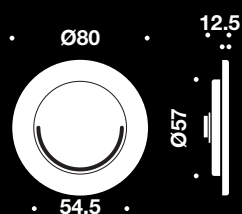

Ø80mm, t/hul t/8mm dørgrebspind

14.3910.02.001

Skydedørsskål oval



Skydedørsskål oval

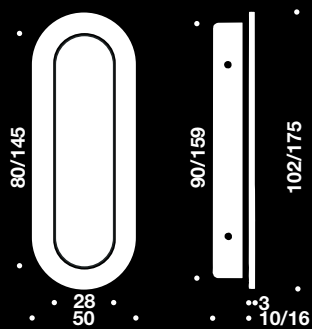

Beskrivelse
50x102mm
58x175mm

Varenummer
14.3950.02.105
14.3950.02.164

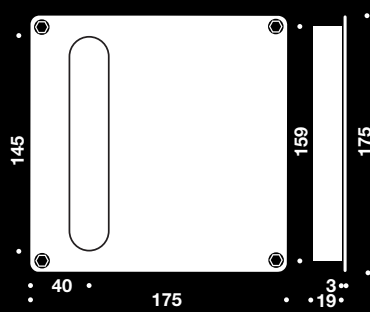

58x175 på faconskilt 175x175mm

14.3970.02.111

Langskilte MATRIX SKA standard

Dørgrebs-
 placering



Blind



M/dørgrebs-
 hul



Oval
 cylinder



Ø40mm
 hul



Rokoko
 cylinder



Vridergreb



Vridergreb -
 handicap



Toilet

210x60x2mm

Side 140

Side 142

Side 144

Side 146

Side 148

Side 150

Side 152

210x30x3mm

Side 154

Side 156

Side 158

Side 160

Side 162

175x175x2mm

Side 164

Side 166

Side 170

Side 172

Side 174

Side 176

SKA

d line
KNUD HOLSCHER DESIGN

Blind



Blind

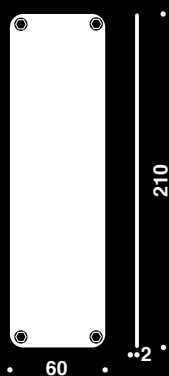

Beskrivelse
210x60x2mm

Varenummer
14.3701.02.008

SKA

d line
KNUD HOLSCHER DESIGN

M/dørgrebshul



M/dørgrebshul

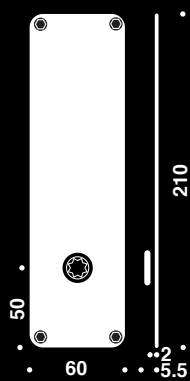

Beskrivelse
T/ASSA, 210x60x2mm

Varenummer
14.3650.02.011

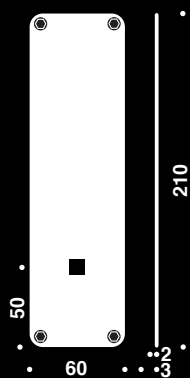

T/ASSA, 210x60x3mm

14.3550.02.010

Ovalcylinder



Ovalcylinder

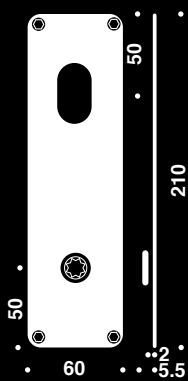

Beskrivelse

T/ASSA, 210x60x2mm, X=105mm

Varenummer

14.3650.02.097

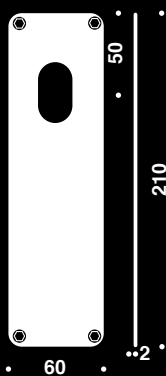

T/ASSA, 210x60x2mm

14.3650.02.000

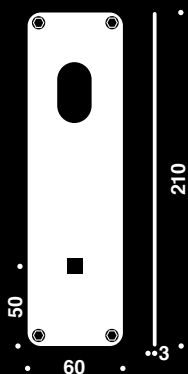

T/ASSA, 210x60x3mm, X=105mm

14.3550.02.285

Ø40mm hul



Ø40mm hul

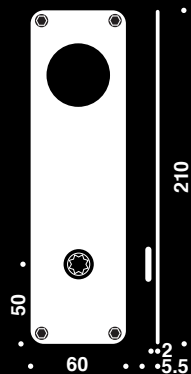

Beskrivelse
T/ASSA, 210x60x2mm, X=111mm

Varenummer
14.3650.02.291

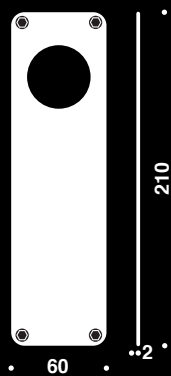

T/ASSA, 210x60x2mm

14.3650.02.280

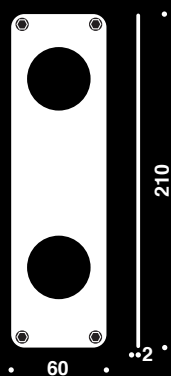

T/ASSA, 210x60x2mm, X=111mm

14.3650.02.170

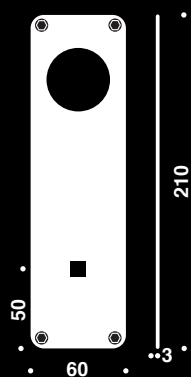

T/ASSA, 210x60x3mm, X=111mm

14.3550.02.290

Vridergreb



Vridergreb

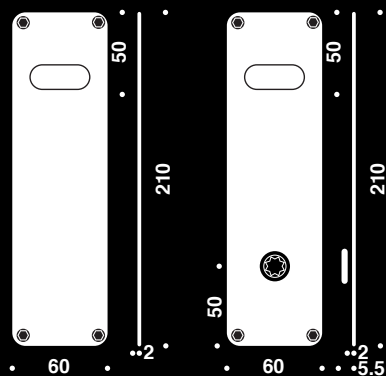

Beskrivelse

T/ASSA, 210x60x2mm, X=105mm

M/dørgrebshul, t/ASSA, 210x60x2mm, X=105mm

Varenummer

14.3650.02.100

14.3650.02.135

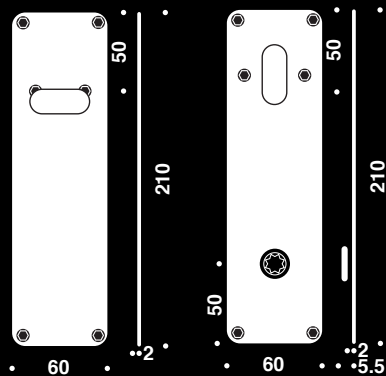

T/ASSA, 210x60x2mm, X=105mm

M/dørgrebshul, t/ASSA, 210x60x2mm, X=105mm

14.3650.02.130

14.3650.02.125

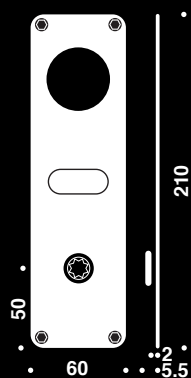

T/ASSA, 210x60x2mm, X=111

14.3650.02.391

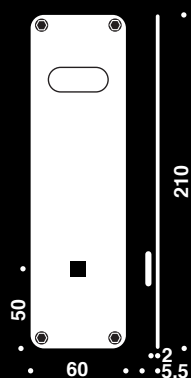

T/ASSA, 210x60x3mm, X=105mm

14.3550.02.130

Vridergreb – handicap



Vridergreb – handicap

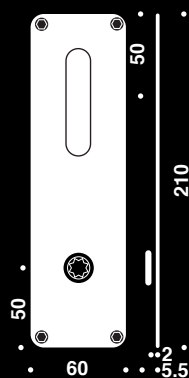

Beskrivelse

T/ASSA, 210x60x2mm, X=105mm

Varenummer

14.3650.02.150

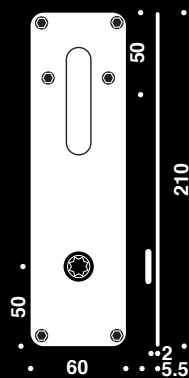

T/ASSA, 210x60x2mm, X=105mm, H

14.3650.02.250

T/ASSA, 210x60x2mm, X=105mm, V

14.3650.02.350

Toiletbesætning



Toiletbesætning

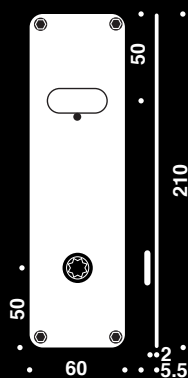

Beskrivelse

T/ASSA m/vridergreb, 210x60x2mm, X=105mm

Varenummer

14.3650.02.453

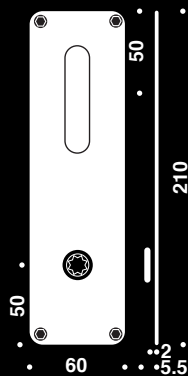

T/ASSA m/vridergreb – handicap, 210x60x2mm, X=105mm

14.3650.02.450

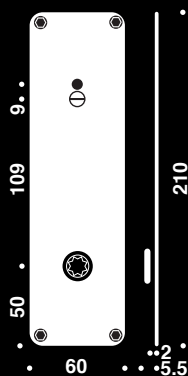

T/ASSA, 210x60x2mm, X=105mm

14.3650.02.411

SKA

d line
KNUD HOLSCHER DESIGN

Blind



Blind



Beskrivelse

Indvendig, t/ASSA, 210x30x3mm

Udvendig, t/ASSA, 210x30x3mm

Varenummer

14.3660.02.015

14.3701.02.200

SKA

d line
KNUD HOLSCHER DESIGN

M/dørgrebshul



M/dørgrebshul



Beskrivelse
T/ASSA, 210x30x3mm

Varenummer
14.3660.02.023

Ovalcylinder



Ovalcylinder



Beskrivelse

Indvendig, t/ASSA, 210x30x3mm, X=105

Indvendig, t/ASSA, 210x30x3mm, X=115

Udvendig, t/ASSA, 210x30x3mm, X=115-8mm

Udvendig, t/ASSA, 210x30x3mm, X=115-12mm

Udvendig, t/ASSA, 210x30x3mm, X=115-16mm

Udvendig, t/ASSA, 210x30x3mm, X=115-20mm

Varenummer

14.3660.02.097

14.3660.02.031

14.3662.02.081

14.3662.02.120

14.3662.02.162

14.3662.02.201

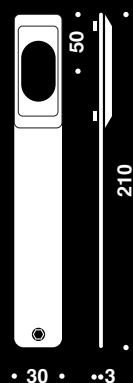

Indvendig, t/ASSA, 210x30x3mm

14.3660.02.058

Udvendig, t/ASSA, 210x30x3mm, 8mm

14.3661.02.087

Udvendig, t/ASSA, 210x30x3mm, 12mm

14.3661.02.125

Udvendig, t/ASSA, 210x30x3mm, 16mm

14.3661.02.168

Udvendig, t/ASSA, 210x30x3mm, 20mm

14.3661.02.206



Udvendig, t/ASSA, 210x30x3mm, X=0-0mm

14.3663.02.035

Udvendig, t/ASSA, 210x30x3mm, X=0-8mm

14.3663.02.086

Udvendig, t/ASSA, 210x30x3mm, X=0-12mm

14.3663.02.124

Udvendig, t/ASSA, 210x30x3mm, X=0-16mm

14.3663.02.167

Udvendig, t/ASSA, 210x30x3mm, X=0-20mm

14.3663.02.205

Rokoko cylinder



Rokoko cylinder



Beskrivelse

- Udvendig, t/ASSA, 210x30x3mm, X=115-8mm
- Udvendig, t/ASSA, 210x30x3mm, X=115-12mm
- Indvendig, t/ASSA, 210x30x3mm, X=115-16mm
- Udvendig, t/ASSA, 210x30x3mm, X=115-20mm

Varenummer

- 14.3672.02.085
- 14.3672.02.123
- 14.3672.02.166
- 14.3672.02.204

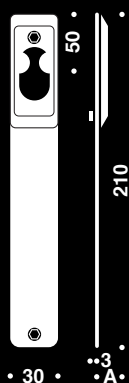

- Udvendig, t/ASSA, 210x30x3mm, X=0-8mm
- Udvendig, t/ASSA, 210x30x3mm, X=0-12mm
- Indvendig, t/ASSA, 210x30x3mm, X=0-16mm
- Udvendig, t/ASSA, 210x30x3mm, X=0-20mm

- 14.3671.02.081
- 14.3671.02.129
- 14.3671.02.161
- 14.3671.02.200

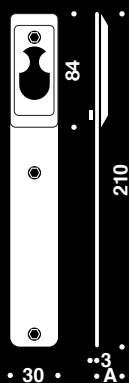

- Indvendig, t/ASSA, 210x30x3mm, X=115-8mm
- Indvendig, t/ASSA, 210x30x3mm, X=115-12mm
- Indvendig, t/ASSA, 210x30x3mm, X=115-16mm
- Indvendig, t/ASSA, 210x30x3mm, X=115-20mm

- 14.3673.02.080
- 14.3673.02.128
- 14.3673.02.161
- 14.3673.02.209

SKA

d line
KNUD HOLSCHER DESIGN

Vridergreb



Vridergreb

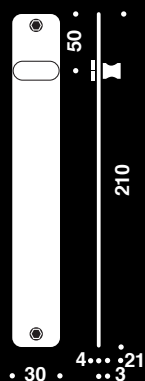

Beskrivelse

T/ASSA, 210x30x3mm

Varenummer

14.3660.02.066

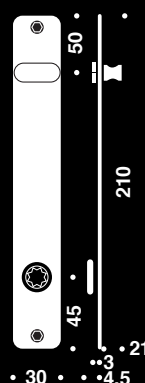

T/ASSA, 210x30x3mm, X=105

14.3660.02.135

T/ASSA, 210x30x3mm, X=115

14.3660.02.040

SKA

d line
KNUD HOLSCHER DESIGN

Blind

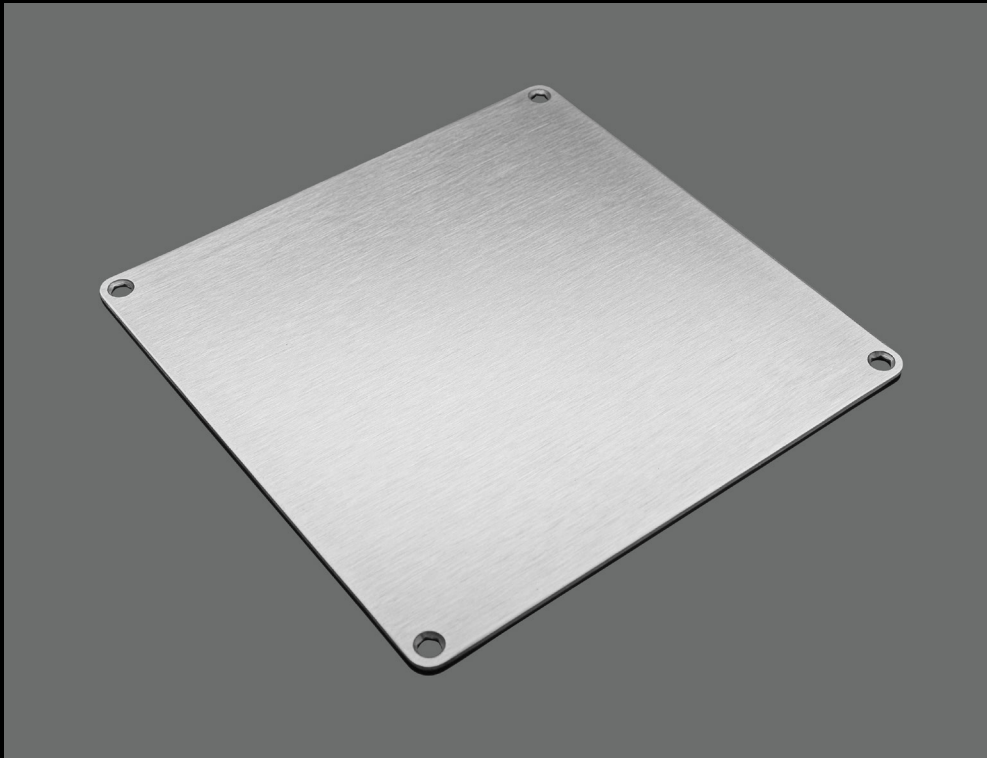

Blind

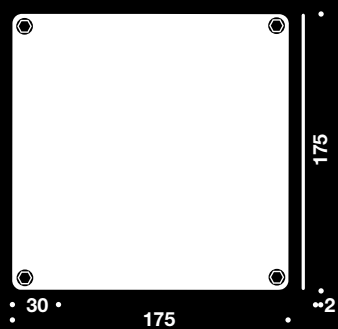

Beskrivelse
175x175x2mm

Varenummer
14.3776.02.006

M/dørgrebshul til oval cylinder



M/dørgrebshul til oval cylinder

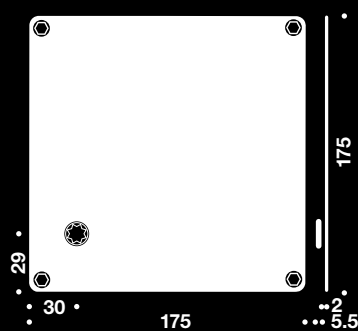

Beskrivelse

V, til oval cylinder, 175x175x2mm

H, til oval cylinder, 175x175x2mm

Varenummer

14.3675.02.038

14.3675.02.020

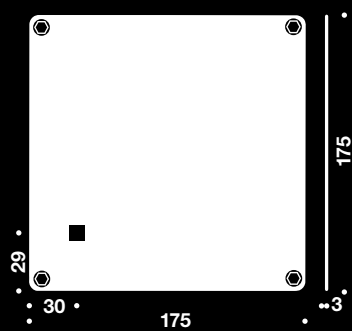

V, t/ASSA, 175x175x3mm

H, t/ASSA, 175x175x3mm

14.3575.02.038

14.3575.02.020

SKA

d line
KNUD HOLSCHER DESIGN

Oval cylinder



Oval cylinder

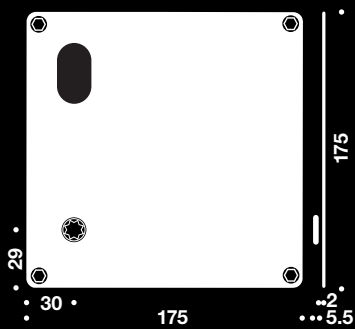

Beskrivelse

V, t/ASSA, 175x175x2mm, X=105

H, t/ASSA, 175x175x2mm, X=105

Varenummer

14.3675.02.119

14.3675.02.101

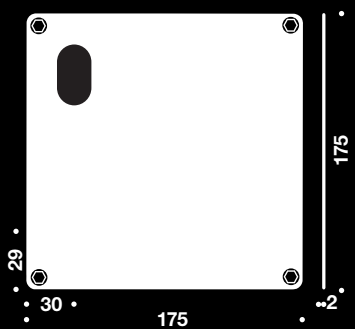

V, t/ASSA, 175x175x2mm

H, t/ASSA, 175x175x2mm,

14.3675.02.300

14.3675.02.200

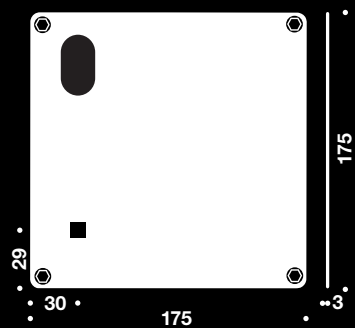

V, t/ASSA, 175x175x3mm, X=105

H, t/ASSA, 175x175x3mm, X=105

14.3575.02.119

14.3575.02.101

SKA

d line
KNUD HOLSCHER DESIGN

Ø40mm hul



Ø40mm hul

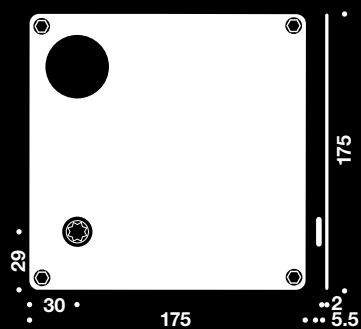

Beskrivelse
 V, t/ASSA, 175x175x2mm, X=111
 H, t/ASSA, 175x175x2mm, X=111

Varenummer
 14.3675.02.313
 14.3675.02.305

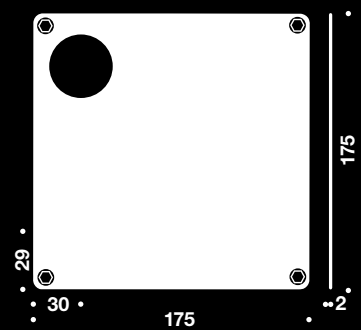

V, H/ASSA, 175x175x2mm
 H, t/ASSA, 175x175x2mm

14.3776.02.313
 14.3776.02.305

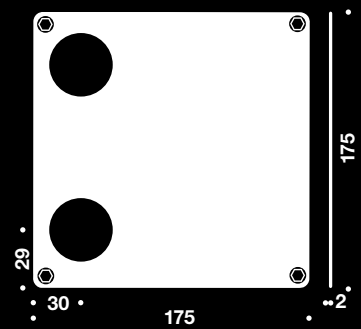

V, t/ASSA, 175x175x2mm, X=111
 H, t/ASSA, 175x175x2mm, X=111

14.3675.02.311
 14.3675.02.211

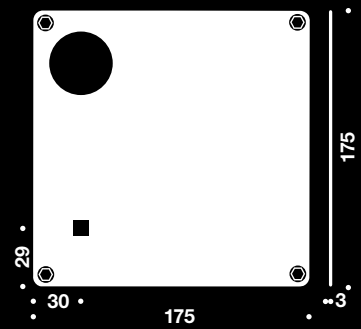

V, t/ASSA, 175x175x3mm, X=111
 H, t/ASSA, 175x175x3mm, X=111

14.3575.02.305
 14.3575.02.313

Vridergreb

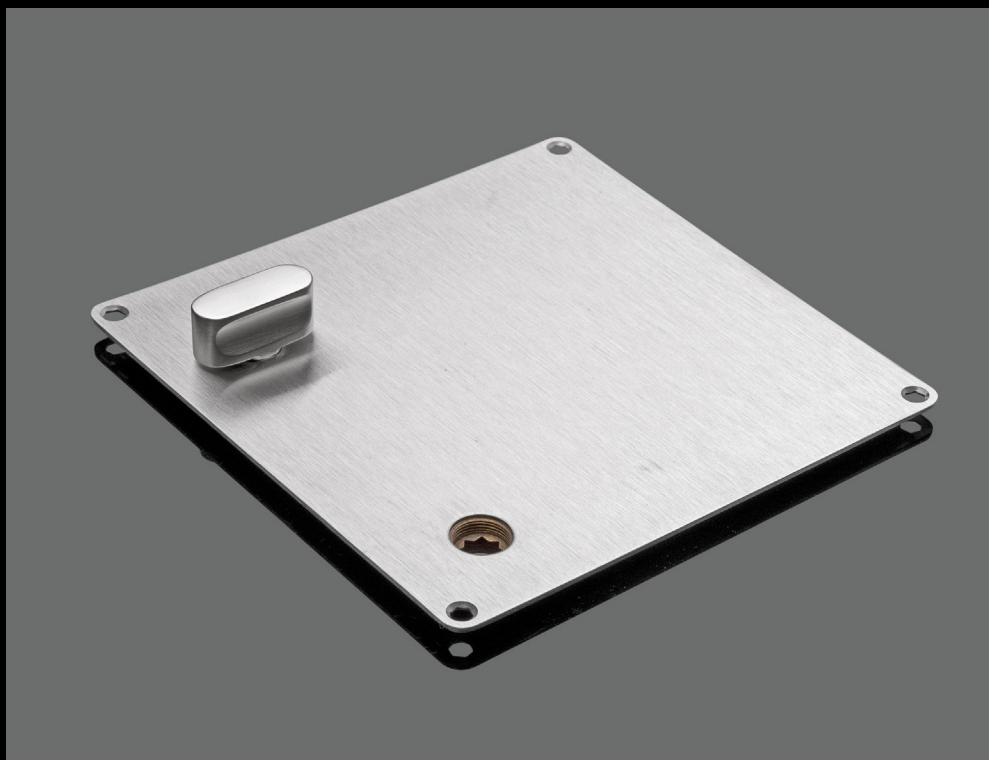

Vridergreb

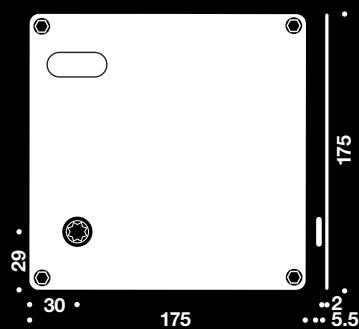
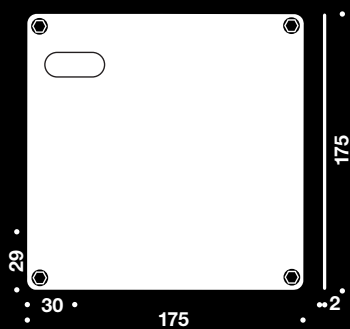

Beskrivelse

V, t/ASSA, u/dørgrebshul 175x175x2mm,
H, t/ASSA, u/dørgrebshul 175x175x2mm,

Varenummer

14.3675.02.350
14.3675.02.250

V, t/ASSA, m/dørgrebshul 175x175x2mm, X=105 14.3675.02.151
H, t/ASSA, m/dørgrebshul 175x175x2mm, X=105 14.3675.02.143

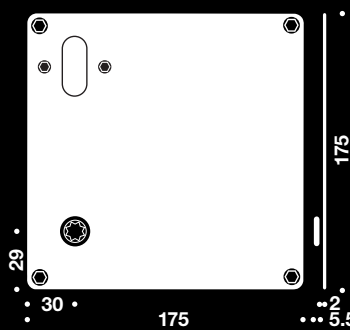

V, t/ASSA, 175x175x2mm, X=105
H, t/ASSA, 175x175x2mm, X=105

14.3675.02.355
14.3675.02.255

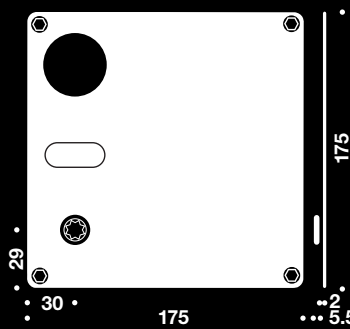

V, t/ASSA 2000, 175x175x2mm, X=111
H, t/ASSA 2000, 175x175x2mm, X=111

14.3675.02.310
14.3675.02.210

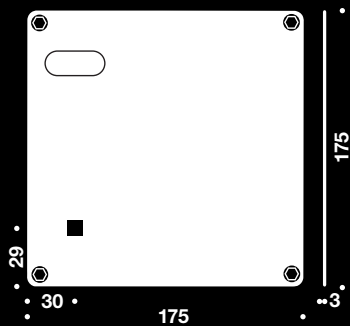

V, t/ASSA, 175x175x3mm, X=105
H, t/ASSA, 175x175x3mm, X=105

14.3575.02.151
14.3575.02.143

Vridergreb – handicap

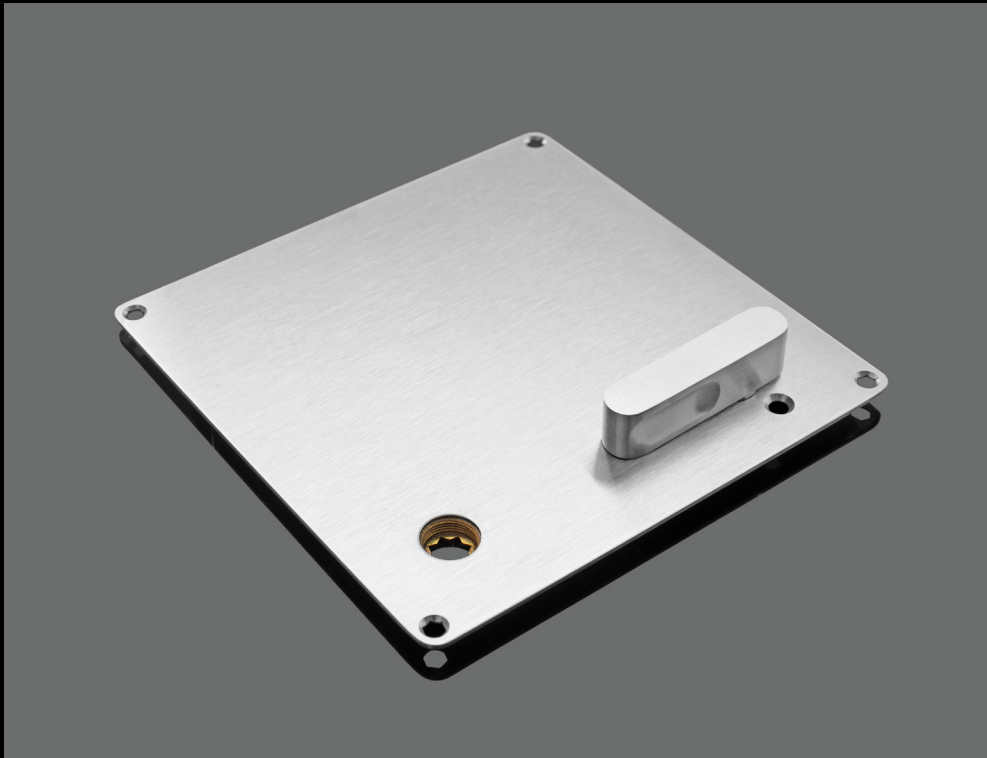

Vridergreb – handicap

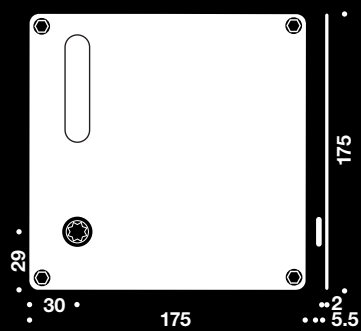

Beskrivelse

V, t/ASSA, 175x175x2mm, X=105

H, t/ASSA, 175x175x2mm, X=105

Varenummer

14.3675.02.351

14.3675.02.251

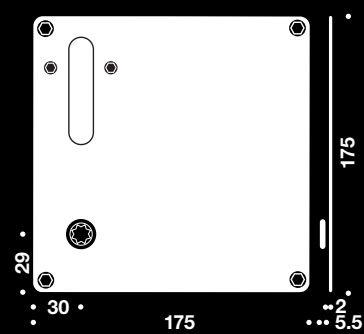

V, t/ASSA, 175x175x2mm, X=105

H, t/ASSA, 175x175x2mm, X=105

14.3675.02.353

14.3675.02.253

SKA

d line
KNUD HOLSCHER DESIGN

Toiletbesætning

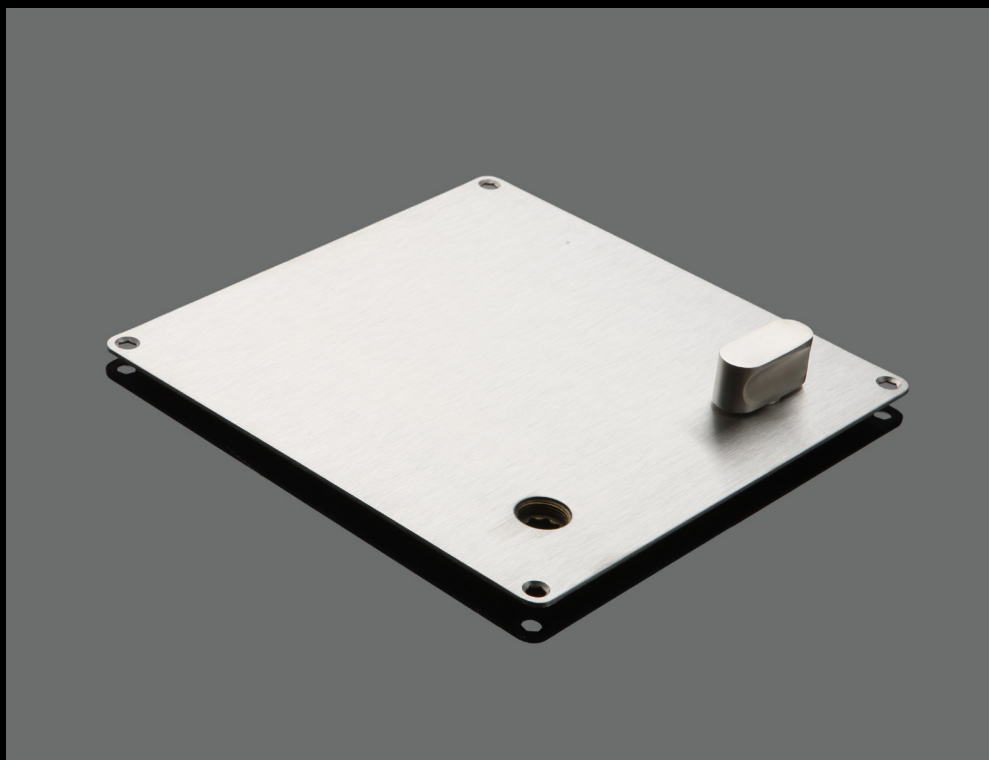

Toiletbesætning

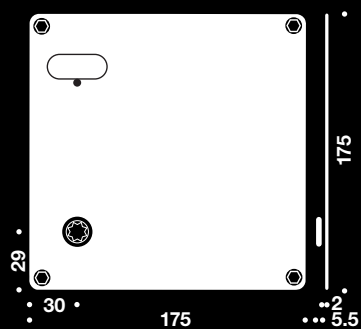

Beskrivelse

V, t/ASSA, 175x175x2mm, X=105

H, t/ASSA, 175x175x2mm, X=105

Varenummer

14.3675.02.470

14.3675.02.461

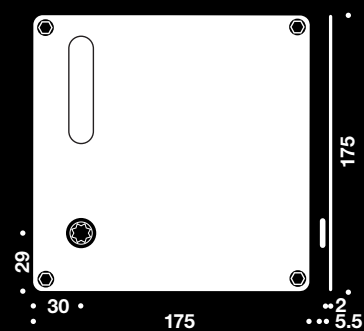

V, t/ASSA, 175x175x2mm, X=105

H, t/ASSA, 175x175x2mm, X=105

14367502370

14367502270

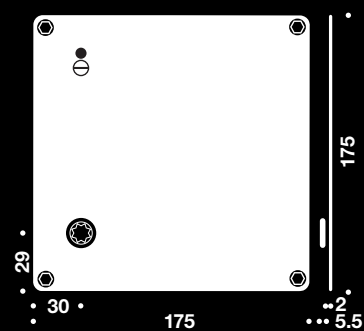

V, t/ASSA, 175x175x2mm, X=105

H, t/ASSA, 175x175x2mm, X=105

14.3675.02.437

14.3675.02.429

Langskilte MATRIX DIN standard

Dørgrebs-
 placering



Blind



M/dørgrebs-
 hul



PZ
 cylinderhul



Keso/kaba
 cylinderhul



Vridergreb



Vridergreb -
 handicap



Toilet



Nøglehul

210x60x2mm
 210x42x2mm
 170x60x2mm

Side 180

Side 182

Side 184

Side 186

Side 188

Side 190

Side 192

Side 194

210x30x2mm

Side 196

Side 198

Side 200

Side 202

175x175x2mm

Side 204

Side 206

Side 208

Side 210

Side 212

Side 214

DIN

d line
KNUD HOLSCHER DESIGN

Blind



Blind



Beskrivelse
T/ASSA, 210x60x2mm

Varenummer
14.3701.02.008



T/DIN, 210x42x2mm

14.3601.02.100

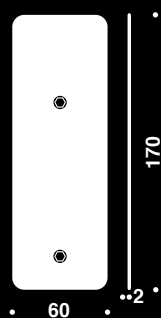

T/DIN, 170x60x2mm

14.3615.02.005

DIN

d line
KNUD HOLSCHER DESIGN

M/dørgrebshul



M/dørgrebshul

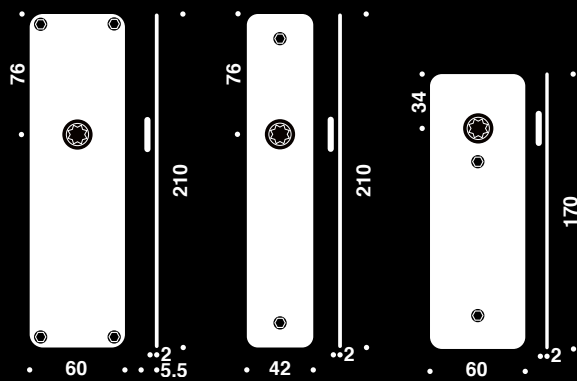

Beskrivelse
 T/DIN, 210x60x2mm
 T/DIN, 210x42x2mm
 T/DIN, 170x60x2mm

Varenummer
 14.3602.02.012
 14.3601.02.101
 14.3615.02.010

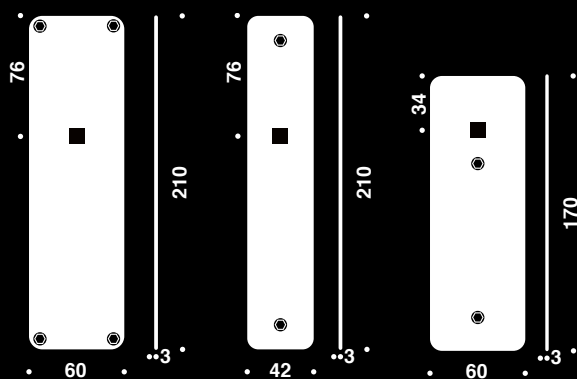

Beskrivelse
 T/DIN, 210x60x3mm
 T/DIN, 210x42x3mm
 T/DIN, 170x60x3mm

Varenummer
 14.3502.02.010
 14.3501.02.182
 14.3515.02.010

PZ cylinderhul



PZ cylinderhul

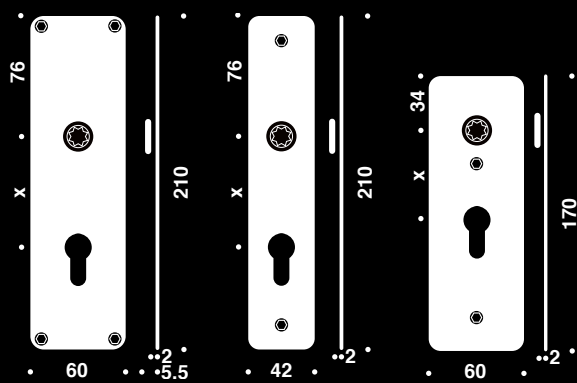

Beskrivelse

- T/DIN, 210x60x2mm, X=55
- T/DIN, 210x60x2mm, X=70
- T/DIN, 210x60x2mm, X=72
- T/DIN, 210x60x2mm, X=88
- T/DIN, 210x60x2mm, X=92

Varenummer

- 14.3602.02.205
- 14.3602.02.250
- 14.3602.02.292
- 14.3602.02.381
- 14.3602.02.211

- T/DIN, 210x42x2mm, X=55
- T/DIN, 210x42x2mm, X=70
- T/DIN, 210x42x2mm, X=72
- T/DIN, 210x42x2mm, X=88
- T/DIN, 210x42x2mm, X=92

- 14.3601.02.355
- 14.3601.02.365
- 14.3601.02.372
- 14.3601.02.385
- 14.3601.02.395

- T/DIN, 170x60x2mm, X=55
- T/DIN, 170x60x2mm, X=70
- T/DIN, 170x60x2mm, X=72
- T/DIN, 170x60x2mm, X=88
- T/DIN, 170x60x2mm, X=92

- 14.3615.02.974
- 14.3615.02.280
- 14.3615.02.290
- 14.3615.02.383
- 14.3615.02.292

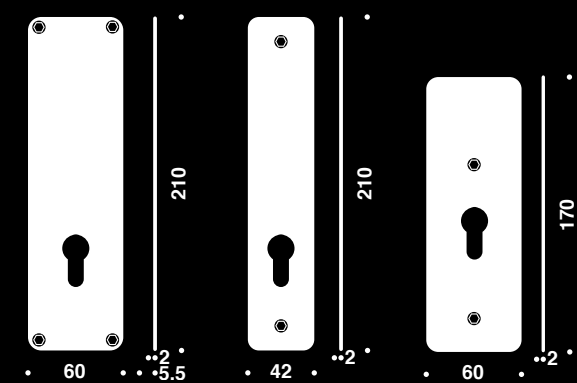

- T/DIN, 210x60x2mm
- T/DIN, 210x60x2mm
- T/DIN, 210x60x2mm
- T/DIN, 210x60x2mm
- T/DIN, 210x60x2mm

- 14.3602.02.155
- 14.3602.02.170
- 14.3602.02.172
- 14.3602.02.188
- 14.3602.02.192

- T/DIN, 210x42x2mm
- T/DIN, 210x42x2mm
- T/DIN, 210x42x2mm
- T/DIN, 210x42x2mm
- T/DIN, 210x42x2mm

- 14.3601.02.155
- 14.3601.02.170
- 14.3601.02.172
- 14.3601.02.188
- 14.3601.02.192

- T/DIN, 170x60x2mm
- T/DIN, 170x60x2mm
- T/DIN, 170x60x2mm
- T/DIN, 170x60x2mm
- T/DIN, 170x60x2mm

- 14.3615.02.155
- 14.3615.02.170
- 14.3615.02.172
- 14.3615.02.188
- 14.3615.02.192

Keso/kaba cylinderhul



Keso/kaba cylinderhul

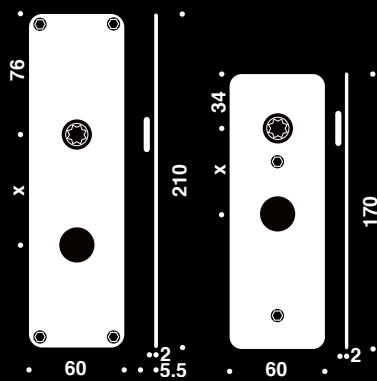

Beskrivelse
 T/DIN, 210x60x2mm, X=73,5
 T/DIN, 170x60x2mm, X=73,5

Varenummer
 14.3602.02.030
 14.3615.02.030

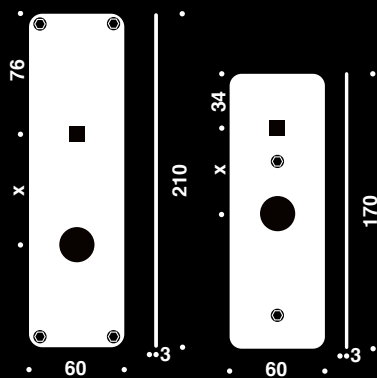

T/DIN, 210x60x3mm, X=73,5
 T/DIN, 170x60x3mm, X=73,5

14.3502.02.900
 14.3515.02.930

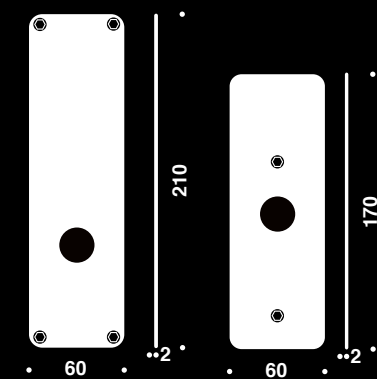

T/DIN, 210x60x2mm
 T/DIN, 170x60x2mm

14.3602.02.890
 14.3615.02.890

DIN

d line
KNUD HOLSCHER DESIGN

Toilet vridergreb



Toilet vridergreb

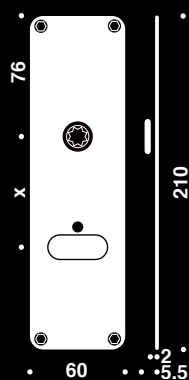

Beskrivelse

- T/DIN, 210x60x2mm, t/8mm pind, X=55
- T/DIN, 210x60x2mm, t/5mm pind, X=57
- T/DIN, 210x60x2mm, t/8mm pind, X=63
- T/DIN, 210x60x2mm, t/8mm pind, X=72
- T/DIN, 210x60x2mm, t/8mm pind, X=78

Varenummer

- 14.3602.02.450
- 14.3602.02.453
- 14.3602.02.460
- 14.3602.02.454
- 14.3602.02.551

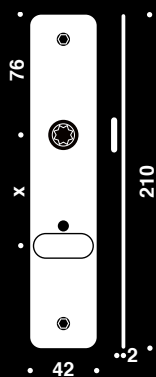

- T/DIN, 210x42x2mm, t/8mm pind, X=55
- T/DIN, 210x42x2mm, t/5mm pind, X=57
- T/DIN, 210x42x2mm, t/8mm pind, X=63
- T/DIN, 210x42x2mm, t/8mm pind, X=72
- T/DIN, 210x42x2mm, t/8mm pind, X=78

- 14.3601.02.455
- 14.3601.02.457
- 14.3601.02.463
- 14.3601.02.472
- 14.3601.02.478

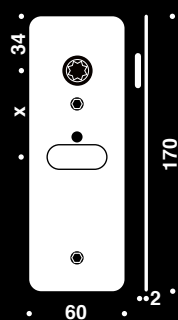

- T/DIN, 170x60x2mm, t/8mm pind, X=55
- T/DIN, 170x60x2mm, t/5mm pind, X=57
- T/DIN, 170x60x2mm, t/8mm pind, X=63
- T/DIN, 170x60x2mm, t/8mm pind, X=72
- T/DIN, 170x60x2mm, t/8mm pind, X=78

- 14.3615.02.455
- 14.3615.02.457
- 14.3615.02.463
- 14.3615.02.472
- 14.3615.02.516

DIN

d line
KNUD HOLSCHER DESIGN

Toilet vridergreb – handicap



Toilet vridergreb – handicap

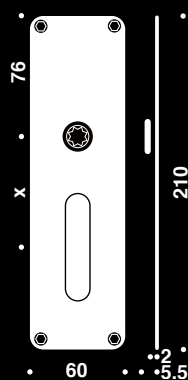

Beskrivelse

- T/DIN, 210x60x2mm, t/8mm pind, X=55
- T/DIN, 210x60x2mm, t/5mm pind, X=57
- T/DIN, 210x60x2mm, t/8mm pind, X=63
- T/DIN, 210x60x2mm, t/8mm pind, X=72
- T/DIN, 210x60x2mm, t/8mm pind, X=78

Varenummer

- 14.3602.02.420
- 14.3602.02.425
- 14.3602.02.430
- 14.3602.02.435
- 14.3602.02.440

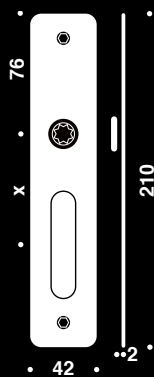

- T/DIN, 210x42x2mm, t/8mm pind, X=55
- T/DIN, 210x42x2mm, t/5mm pind, X=57
- T/DIN, 210x42x2mm, t/8mm pind, X=63
- T/DIN, 210x42x2mm, t/8mm pind, X=72
- T/DIN, 210x42x2mm, t/8mm pind, X=78

- 14.3601.02.420
- 14.3601.02.425
- 14.3601.02.430
- 14.3601.02.435
- 14.3601.02.440

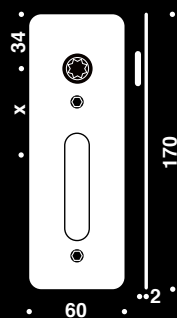

- T/DIN, 170x60x2mm, t/8mm pind, X=55
- T/DIN, 170x60x2mm, t/5mm pind, X=57
- T/DIN, 170x60x2mm, t/8mm pind, X=63
- T/DIN, 170x60x2mm, t/8mm pind, X=72
- T/DIN, 170x60x2mm, t/8mm pind, X=78

- 14.3615.02.420
- 14.3615.02.425
- 14.3615.02.430
- 14.3615.02.435
- 14.3615.02.440

DIN

d line
KNUD HOLSCHER DESIGN

Toiletmarkering



Toiletmarkering

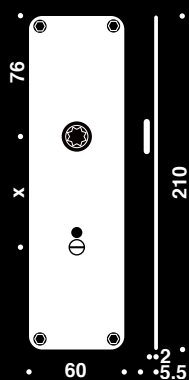

Beskrivelse

- T/DIN, 210x60x2mm, m/8mm pind, X=55
- T/DIN, 210x60x2mm, m/5mm pind, X=57
- T/DIN, 210x60x2mm, m/8mm pind, X=63
- T/DIN, 210x60x2mm, m/8mm pind, X=72
- T/DIN, 210x60x2mm, m/8mm pind, X=78

Varenummer

- 14.3602.02.403
- 14.3602.02.407
- 14.3602.02.409
- 14.3602.02.411
- 14.3602.02.519

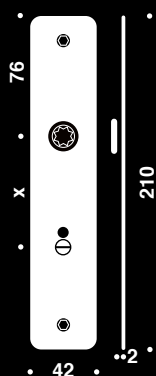

- T/DIN, 210x42x2mm, m/8mm pind, X=55
- T/DIN, 210x42x2mm, m/5mm pind, X=57
- T/DIN, 210x42x2mm, m/8mm pind, X=63
- T/DIN, 210x42x2mm, m/8mm pind, X=72
- T/DIN, 210x42x2mm, m/8mm pind, X=78

- 14.3601.02.405
- 14.3601.02.407
- 14.3601.02.410
- 14.3601.02.413
- 14.3601.02.417

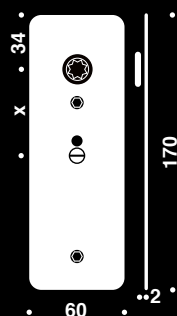

- T/DIN, 170x60x2mm, m/8mm pind, X=55
- T/DIN, 170x60x2mm, m/5mm pind, X=57
- T/DIN, 170x60x2mm, m/8mm pind, X=63
- T/DIN, 170x60x2mm, m/8mm pind, X=72
- T/DIN, 170x60x2mm, m/8mm pind, X=78

- 14.3615.02.405
- 14.3615.02.407
- 15.3615.02.410
- 14.3615.02.413
- 14.3615.02.417

DIN

d line
KNUD HOLSCHER DESIGN

Nøglehul



Nøglehul

			Beskrivelse	Varenummer
			T/DIN, 210x60x2mm, X=56	14.3602.02.050
			T/DIN, 210x60x2mm, X=72	14.3602.02.055
			T/DIN, 210x60x2mm, X=90	14.3602.02.060
			T/DIN, 210x42x2mm, X=56	14.3601.02.256
			T/DIN, 210x42x2mm, X=72	14.3601.02.272
			T/DIN, 210x42x2mm, X=90	14.3601.02.292
			T/DIN, 170x60x2mm, X=56	14.3615.02.050
			T/DIN, 170x60x2mm, X=72	14.3615.02.052
			T/DIN, 170x60x2mm, X=90	14.3615.02.092

			T/DIN, 210x60x2mm	14.3602.02.020
			T/DIN, 210x42x2mm	14.3601.02.020
			T/DIN, 170x60x2mm	14.3615.02.020

			T/DIN, 210x60x3mm, X=56	14.3502.02.045
			T/DIN, 210x42x3mm, X=56	14.3501.02.045
			T/DIN, 170x60x3mm, X=56	14.3615.02.045

DIN

d line
KNUD HOLSCHER DESIGN

M/dørgrebshul



M/dørgrebshul



Beskrivelse

T/DIN, 210x30x3mm (dørgrebshul fra top 67mm)

T/DIN, 210x30x3mm (dørgrebshul fra top 87mm)

Varenummer

14.3640.02.005

14.3640.02.010



T/DIN, 210x30x3mm (dørgrebshul fra top 67mm)

T/DIN, 210x30x3mm (dørgrebshul fra top 87mm)

14.3541.02.005

14.3541.02.010

DIN

d line
KNUD HOLSCHER DESIGN

PZ cylinderhul



PZ cylinderhul

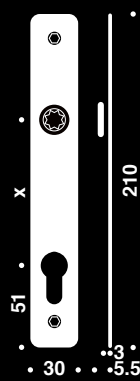

Beskrivelse

T/DIN, 210x30x3mm, X=92 (dørgrebshul fra top 67mm), intern

T/DIN, 210x30x3mm, X=72 (dørgrebshul fra top 87mm), intern

Varenummer

14.3642.02.033

14.3640.02.034

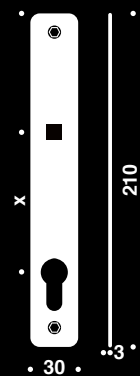

T/DIN, 210x30x3mm, X=92 (dørgrebshul fra top 67mm), intern

14.3542.02.210

T/DIN, 210x30x3mm, X=72 (dørgrebshul fra top 87mm), intern

14.3541.02.290

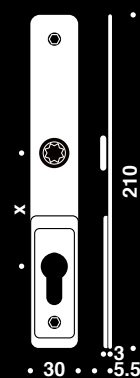

T/DIN, 210x30x3mm, X=92-8mm (dørgrebshul fra top 67mm), ekstern

14.3642.02.089

T/DIN, 210x30x3mm, X=92-12mm (dørgrebshul fra top 67mm), ekstern

14.3642.02.127

T/DIN, 210x30x3mm, X=72-8mm (dørgrebshul fra top 87mm), ekstern

14.3640.02.080

T/DIN, 210x30x3mm, X=72-12mm (dørgrebshul fra top 87mm), ekstern

14.3640.02.128

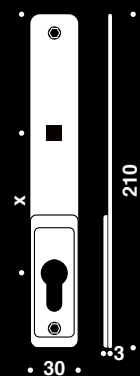

T/DIN, 210x30x3mm, X=92-8mm (dørgrebshul fra top 67mm), ekstern

14.3542.02.305

T/DIN, 210x30x3mm, X=72-8mm (dørgrebshul fra top 87mm), ekstern

14.3542.02.310

DIN

d line
KNUD HOLSCHER DESIGN

Toilet vridergreb



Toilet vridergreb

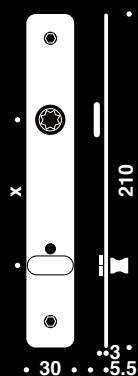

Beskrivelse

T/DIN, 210x30x3mm, t/8mm pind, X=63 (dørgrebshul fra top 87mm)

T/DIN, 210x30x3mm, t/8mm pind, X=72 (dørgrebshul fra top 87mm)

Varenummer

14.3640.02.205

14.3640.02.210

DIN

d line
KNUD HOLSCHER DESIGN

Toiletmarkering



Toiletmarkering

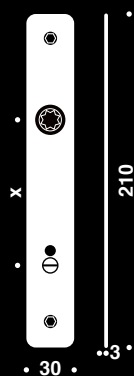

Beskrivelse

T/DIN, 210x30x3mm, m/8mm pind, X=63 (dørgrebshul fra top 87mm)

T/DIN, 210x30x3mm, m/8mm pind, X=72 (dørgrebshul fra top 87mm)

Varenummer

14.3640.02.305

14.3640.02.310

DIN

d line
KNUD HOLSCHER DESIGN

M/dørgrebshul

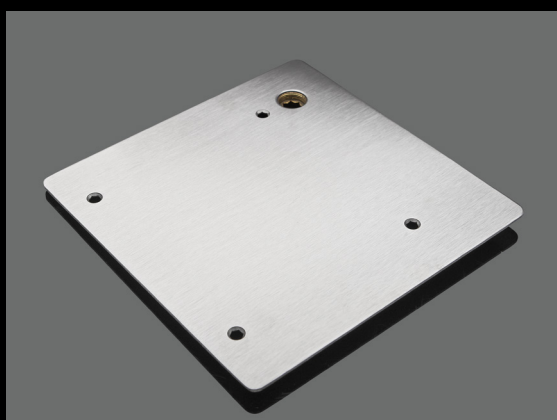
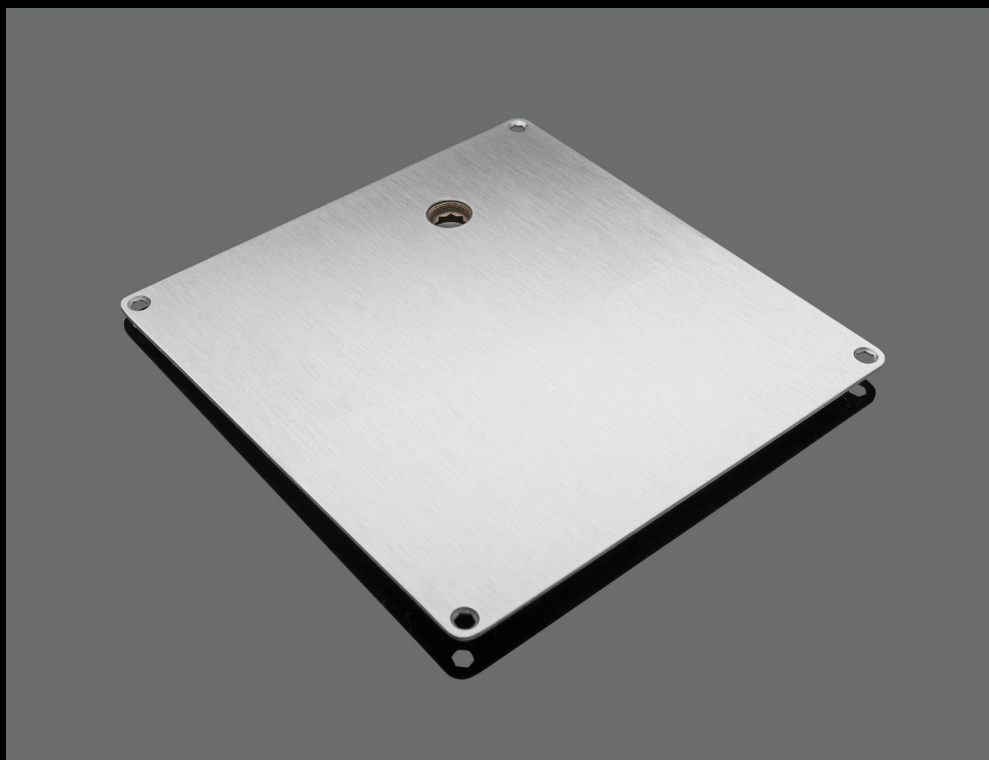

M/dørgrebshul

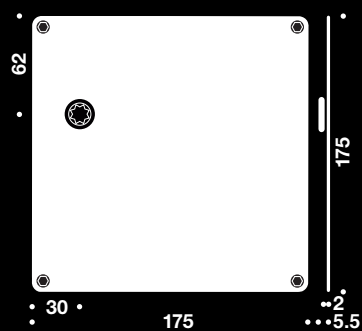

Beskrivelse

T/DIN, 175x175x2mm, X=0 (30x62mm fra top), V

T/DIN, 175x175x2mm, X=0 (30x62mm fra top), H

Varenummer

14.3625.02.030

14.3625.02.021

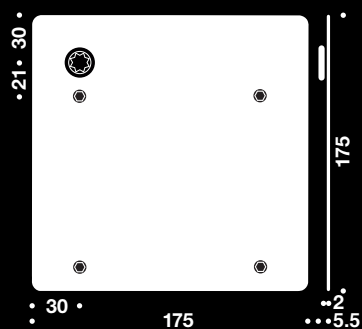

T/DIN, 175x175x2mm, X=0 (30x30mm fra top)

T/DIN, 175x175x2mm, X=0 (30x30mm fra top)

14.3636.02.038

14.3636.02.020

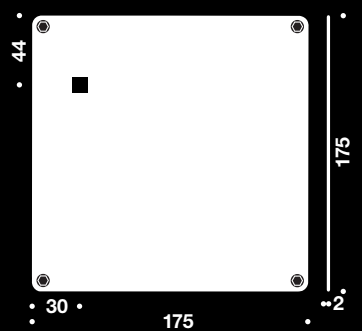

T/DIN, 175x175x2mm, X=0 (30x44mm fra top), V

T/DIN, 175x175x2mm, X=0 (30x44mm fra top), H

14.3522.02.030

14.3522.02.020

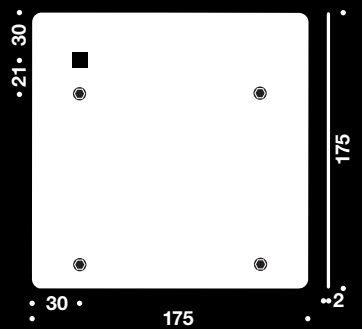

T/DIN, 175x175x2mm, X=0 (30x30mm fra top), V

T/DIN, 175x175x2mm, X=0 (30x30mm fra top), H

14.3536.02.030

14.3536.02.020

PZ cylinderhul



PZ cylinderhul

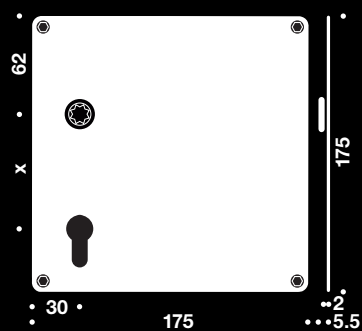

Beskrivelse

- T/DIN, 175x175x2mm, X=55 (30x62mm fra top), V
- T/DIN, 175x175x2mm, X=55 (30x62mm fra top), H
- T/DIN, 175x175x2mm, X=72 (30x62mm fra top), V
- T/DIN, 175x175x2mm, X=72 (30x62mm fra top), H

Varenummer

- 14.3625.02.213
- 14.3625.02.205
- 14.3625.02.315
- 14.3625.02.307

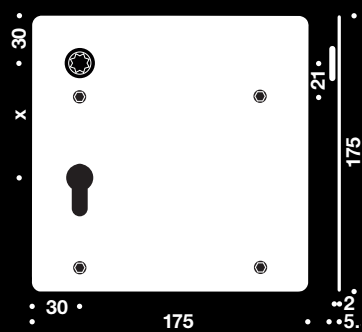

- T/DIN, 175x175x2mm, X=72 (30x30mm fra top), V
- T/DIN, 175x175x2mm, X=72 (30x30mm fra top), H

- 14.3636.02.313
- 14.3636.02.305

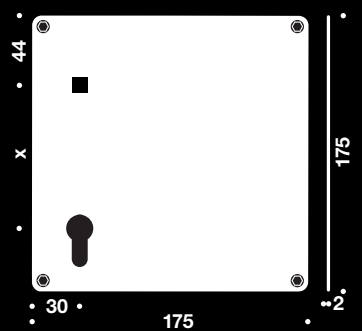

- T/DIN, 175x175x2mm, X=88 (30x44mm fra top), V
- T/DIN, 175x175x2mm, X=88 (30x44mm fra top), H

- 14.3522.02.390
- 14.3522.02.380

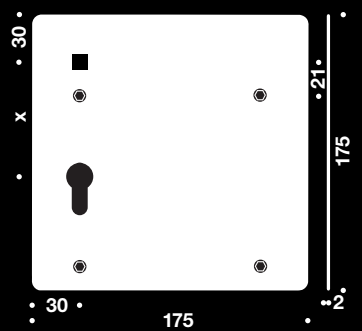

- T/DIN, 175x175x2mm, X=72 (30x30mm fra top), V
- T/DIN, 175x175x2mm, X=72 (30x30mm fra top), H

- 14.3536.02.310
- 14.3536.02.300

DIN

d line
KNUD HOLSCHER DESIGN

Toilet vridergreb

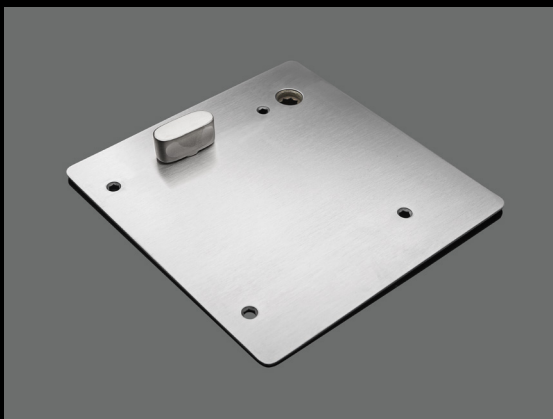

Toilet vridergreb

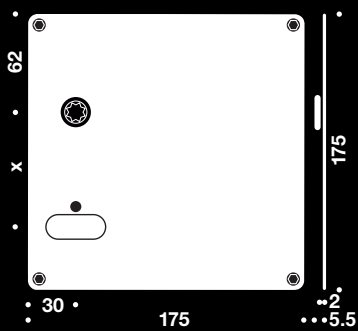

Beskrivelse

T/DIN, 175x175x2mm, t/8mm pind, X=63 (30x62mm fra top), V
 T/DIN, 175x175x2mm, t/8mm pind, X=63 (30x62mm fra top), H
 T/DIN, 175x175x2mm, t/8mm pind, X=72 (30x62mm fra top), V
 T/DIN, 175x175x2mm, t/8mm pind, X=72 (30x62mm fra top), H

Varenummer

14.3625.02.476
 14.3625.02.477
 14.3625.02.498
 14.3625.02.480

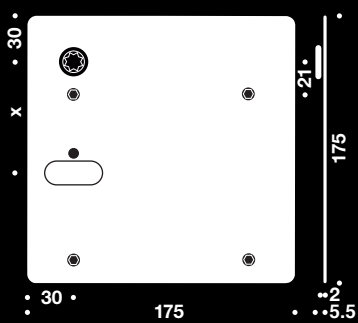

T/DIN, 175x175x2mm, t/8mm pind, X=78 (30x30mm fra top), V
 T/DIN, 175x175x2mm, t/8mm pind, X=78 (30x30mm fra top), H

14.3636.02.577
 14.3636.02.569

DIN

d line
KNUD HOLSCHER DESIGN

Toilet vridergreb – handicap



Toilet vridergreb – handicap

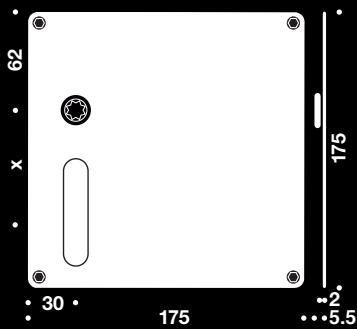

Beskrivelse

- T/DIN, 175x175x2mm, t/8mm pind, X=63 (30x62mm fra top), V
- T/DIN, 175x175x2mm, t/8mm pind, X=63 (30x62mm fra top), H
- T/DIN, 175x175x2mm, t/8mm pind, X=72 (30x62mm fra top), V
- T/DIN, 175x175x2mm, t/8mm pind, X=72 (30x62mm fra top), H

Varenummer

- 14.3625.02.479
- 14.3625.02.478
- 14.3625.02.500
- 14.3625.02.499

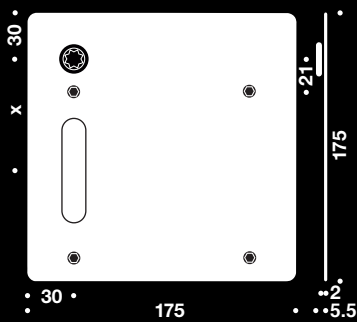

- T/DIN, 175x175x2mm, t/8mm pind, X=78 (30x30mm fra top), V
- T/DIN, 175x175x2mm, t/8mm pind, X=78 (30x30mm fra top), H

- 14.3636.02.587
- 14.3636.02.579

Toiletmarkering

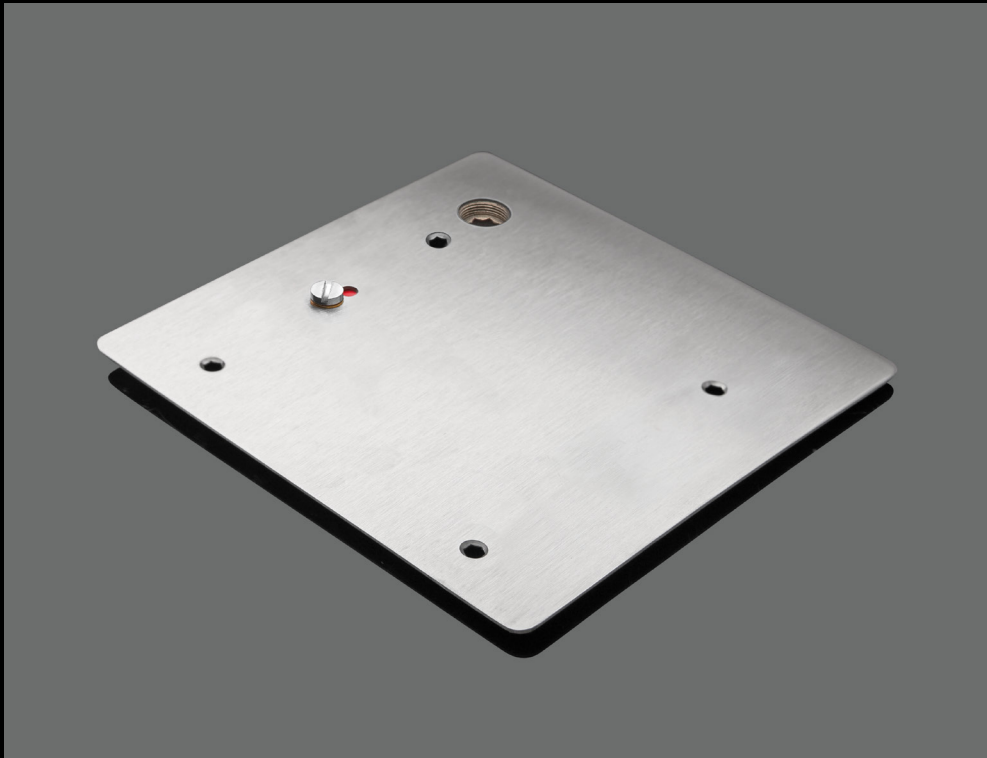

Toiletmarkering

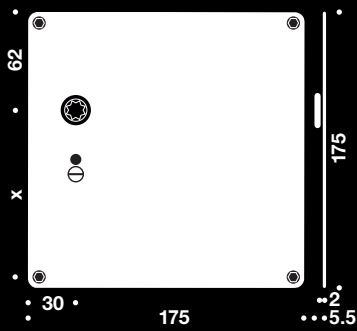

Beskrivelse

T/DIN, 175x175x2mm, m/8mm pind, X=63 (30x62mm fra top), V
 T/DIN, 175x175x2mm, m/8mm pind, X=63 (30x62mm fra top), H
 T/DIN, 175x175x2mm, m/8mm pind, X=72 (30x62mm fra top), V
 T/DIN, 175x175x2mm, m/8mm pind, X=72 (30x62mm fra top), H

Varenummer

14.3625.02.445
 14.3625.02.441
 14.3625.02.455
 14.3625.02.447

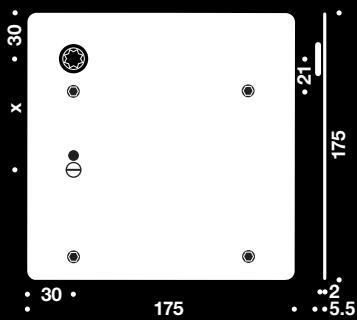

T/DIN, 175x175x2mm, m/8mm pind, X=78 (30x30mm fra top), V
 T/DIN, 175x175x2mm, m/8mm pind, X=78 (30x30mm fra top), H

14.3636.02.534
 14.3636.02.526

DIN

d line
KNUD HOLSCHER DESIGN

Nøglehul



Nøglehul

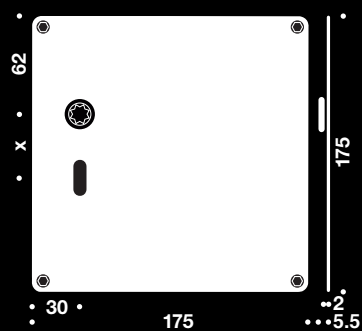

Beskrivelse

T/DIN, 175x175x2mm, X=56 (30x62mm fra top), V
 T/DIN, 175x175x2mm, X=56 (30x62mm fra top), H
 T/DIN, 175x175x2mm, X=72 (30x62mm fra top), V
 T/DIN, 175x175x2mm, X=72 (30x62mm fra top), H

Varenummer

14.3625.02.110
 14.3625.02.105
 14.3625.02.120
 14.3625.02.115

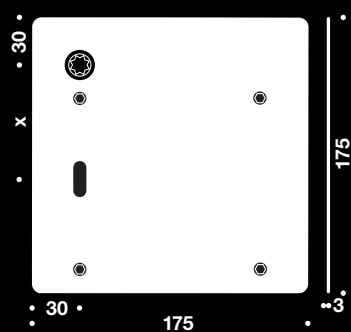

F/DIN 175x175x2 mm, X=72 mm, (30x30 mm fra top), V
 F/DIN 175x175x2 mm, X=72 mm, (30x30 mm fra top), H

14.3636.02.071
 14.3636.02.062

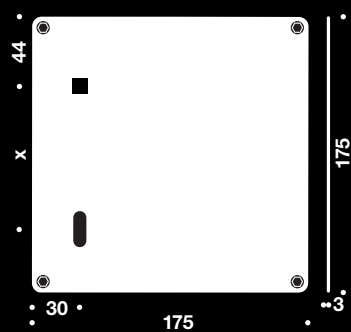

T/DIN, 175x175x3mm, X=90 (30x44mm fra top), V
 T/DIN, 175x175x3mm, X=90 (30x44mm fra top), H

14.3522.02.071
 14.3522.02.061

T/DIN, 175x175x3mm, X=72 (30x30mm fra top), V
 T/DIN, 175x175x3mm, X=72 (30x30mm fra top), H

14.3522.02.050
 14.3522.02.040

Ringetryk



Ringetryk



Beskrivelse
Ø50mm, m/klipsroset

Varenummer
14.5016.02.001

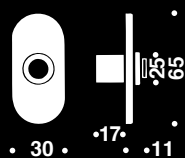

30x65mm, m/oval klipsroset

14.5021.02.002

Kvadratiske piktogrammer 175x175mm



Kvadratiske piktogrammer 175x175mm



Beskrivelse

- Rustfrit stål kvadratisk, kvinde
- Rustfrit stål kvadratisk, mand
- Rustfrit stål kvadratisk, unisex
- Rustfrit stål kvadratisk, handicap
- Rustfrit stål kvadratisk, telefon
- Rustfrit stål kvadratisk, garderobe
- Rustfrit stål kvadratisk, børnerum
- Rustfrit stål kvadratisk, restaurant
- Rustfrit stål kvadratisk, cafe
- Rustfrit stål kvadratisk, ikke ryger
- Rustfrit stål kvadratisk, ryger
- Rustfrit stål kvadratisk, pil

Varenummer

- 14.3777.02.019
- 14.3777.02.027
- 14.3777.02.035
- 14.3777.02.043
- 14.3777.02.051
- 14.3777.02.060
- 14.3777.02.078
- 14.3777.02.086
- 14.3777.02.094
- 14.3777.02.108
- 14.3777.02.116
- 14.3777.02.124

Piktogrammer



Piktogrammer



Ø76

Beskrivelse

Rustfrit stål, mand
 Rustfrit stål, kvinde
 Rustfrit stål, unisex
 Rustfrit stål, branddør hold lukket
 Rustfrit stål, branddør hold låst
 Rustfrit stål, handicap

Varenummer

14.3797.02.350
 14.3797.02.354
 14.3797.02.358
 14.3797.02.362
 14.3797.02.366
 14.3797.02.370

Frosted akryl, mand
 Frosted akryl, kvinde
 Frosted akryl, unisex
 Frosted akryl, branddør hold lukket
 Frosted akryl, branddør hold låst
 Frosted akryl, handicap

14.3797.02.349
 14.3797.02.353
 14.3797.02.357
 14.3797.02.361
 14.3797.02.365
 14.3797.02.369



86

Rustfrit stål kvadratisk, mand
 Rustfrit stål kvadratisk, kvinde
 Rustfrit stål kvadratisk, unisex
 Rustfrit stål kvadratisk, branddør hold lukket
 Rustfrit stål kvadratisk, branddør hold låst
 Rustfrit stål kvadratisk, handicap

14.3797.02.351
 14.3797.02.355
 14.3797.02.359
 14.3797.02.363
 14.3797.02.367
 14.3797.02.371

Frosted akryl kvadratisk, mand
 Frosted akryl kvadratisk, kvinde
 Frosted akryl kvadratisk, unisex
 Frosted akryl kvadratisk, handicap

14.3797.02.400
 14.3797.02.401
 14.3797.02.402
 14.3797.02.403

Futura heavy husnumre og bogstaver

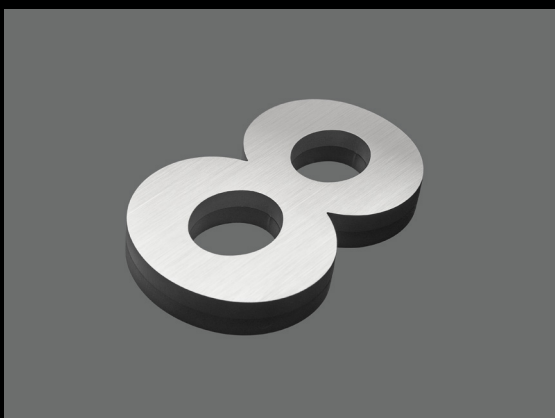

Futura heavy husnumre og bogstaver

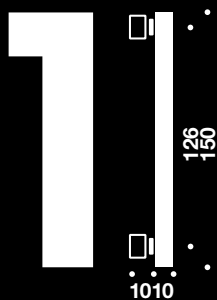

Beskrivelse

- 0, 154x104x10mm
- 1, 146x47x10mm
- 2, 150x96x10mm
- 3, 154x86x10mm
- 4, 149x107x10mm
- 5, 151x97x10mm
- 6, 156x103x10mm
- 7, 151x104x10mm
- 8, 155x86x10mm
- 9, 157x103x10mm

- a, 102x97x10mm
- b, 164x97x10mm
- c, 101x72x10mm
- d, 167x97x10mm
- e, 102x91x10mm
- Bindestreg, 47x10mm
- Punktum, Ø32x10mm

Varenummer

- 14.6020.02.000
- 14.6020.02.001
- 14.6020.02.002
- 14.6020.02.003
- 14.6020.02.004
- 14.6020.02.005
- 14.6020.02.006
- 14.6020.02.007
- 14.6020.02.008
- 14.6020.02.009
- 14.6021.02.001
- 14.6021.02.002
- 14.6021.02.003
- 14.6021.02.004
- 14.6021.02.005
- 14.6021.02.030
- 14.6021.02.040

Møbelhank lige Ø10mm



Møbelhank lige Ø10mm



Beskrivelse

Gevind M5 96mm
Gevind M5 128mm
Gevind M5 224mm
Gevind M5 320mm
Gevind M5 416mm
Gevind M5 512mm

Varenummer

14.3812.02.098
14.3812.02.136
14.3812.02.225
14.3812.02.322
14.3812.02.411
14.3812.02.519

Møbelknop



Møbelknop



Beskrivelse

Ø25mm hoved, gevind M5, Ø25x21mm

Varenummer

14.5600.02.107



Gevind M5, Ø14x23mm

14.5610.02.101



Gevind M5, Ø10x17mm

14.3816.02.011

Møbelhank



Møbelhank



Beskrivelse

Gevind M5, 32mm, cc 32mm

Gevind M5, 40mm, cc 32mm

Varenummer

14.3822.02.024

14.3842.02.030



Gevind M5, forkrøppet, 32mm, cc 32mm

14.3852.02.025

Gevind M5, vinkelbukket 45°, 32mm, cc 32mm

14.3852.02.041

Gevind M5, vinkelbukket 90°, 45mm, cc 32mm

14.3832.02.028



Gevind M8, 45mm, cc 45mm

14.4012.02.049

PZ Cylinder dørhank



PZ Cylinder dørhank

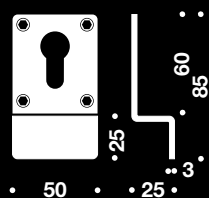

Beskrivelse
50x85x3mm

Varenummer
14.4010.02.290

Dørhanke lige Ø14mm

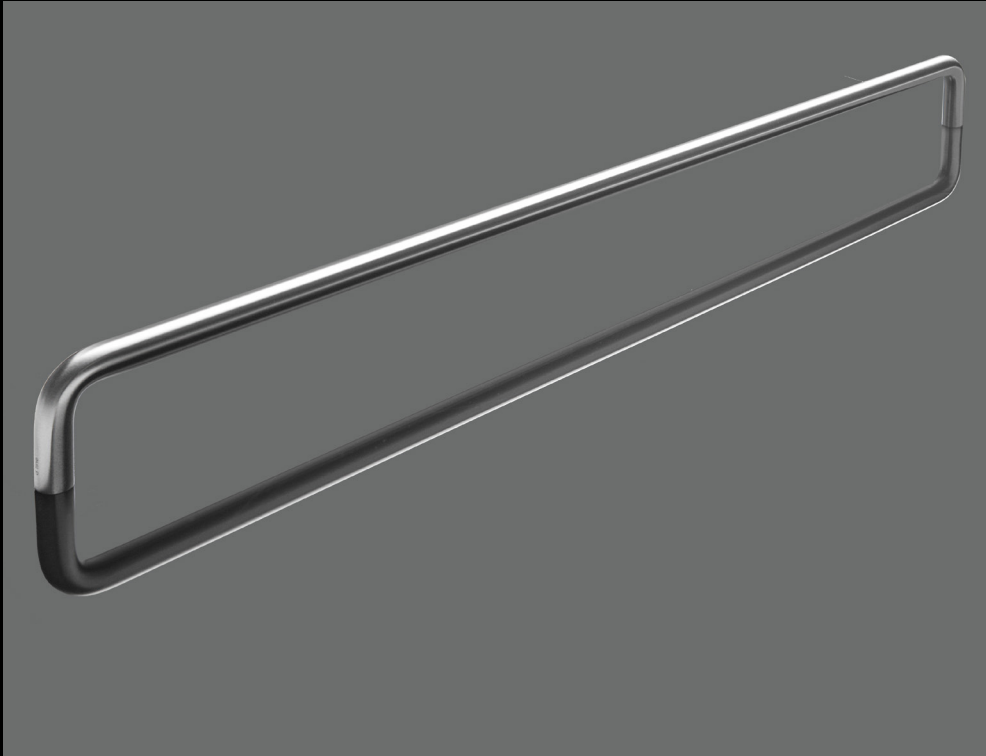

Dørhanke lige Ø14mm

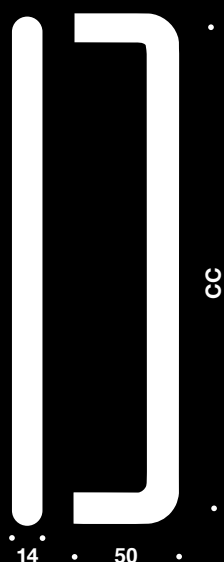

Beskrivelse	Varenummer
Gevind M8 cc 125mm	14.4012.02.120
Gevind M8 cc 300mm	14.4012.02.308
Gevind M8 cc 650mm	14.4012.02.651
Gevind M8 cc 0-300mm	14.4012.02.707
Gevind M8 cc 301-400mm	14.4012.02.715
Gevind M8 cc 401-500mm	14.4012.02.723
Gevind M8 cc 501-600mm	14.4012.02.731
Gevind M8 cc 601-700mm	14.4012.02.740
Gevind M8 cc 701-800mm	14.4012.02.758
Gevind M8 cc 801-900mm	14.4012.02.766
Gevind M8 cc 901-1000mm	14.4012.02.774
Gevind M8 cc 1001-1100mm	14.4012.02.782
Gevind M8 cc 1101-1200mm	14.4012.02.791
Gevind M8 cc 1201-1300mm	14.4012.02.804
Gevind M8 cc 1301-1400mm	14.4012.02.812
Gevind M8 cc 1401-1500mm	14.4012.02.821
Gevind M8 cc 1501-1600mm	14.4012.02.839
Gevind M8 cc 1601-1700mm	14.4012.02.847
Gevind M8 cc 1701-1800mm	14.4012.02.855
Gevind M8 cc 1801-1900mm	14.4012.02.863
Gevind M8 cc 1901-2000mm	14.4012.02.871
Bøsning cc 125mm	14.4014.02.129
Bøsning cc 300mm	14.4014.02.307
Bøsning cc 650mm	14.4014.02.650
Bøsning cc 0-300mm	14.4014.02.706
Bøsning cc 301-400mm	14.4014.02.714
Bøsning cc 401-500mm	14.4014.02.722
Bøsning cc 501-600mm	14.4014.02.731
Bøsning cc 601-700mm	14.4014.02.749
Bøsning cc 701-800mm	14.4014.02.757
Bøsning cc 801-900mm	14.4014.02.765
Bøsning cc 901-1000mm	14.4014.02.773
Bøsning cc 1001-1100mm	14.4014.02.781
Bøsning cc 1101-1200mm	14.4014.02.790
Bøsning cc 1201-1300mm	14.4014.02.803
Bøsning cc 1301-1400mm	14.4014.02.811
Bøsning cc 1401-1500mm	14.4014.02.820
Bøsning cc 1501-1600mm	14.4014.02.838
Bøsning cc 1601-1700mm	14.4014.02.846
Bøsning cc 1701-1800mm	14.4014.02.854
Bøsning cc 1801-1900mm	14.4014.02.862
Bøsning cc 1901-2000mm	14.4014.02.871

Dørhanke forkrøppet Ø14mm

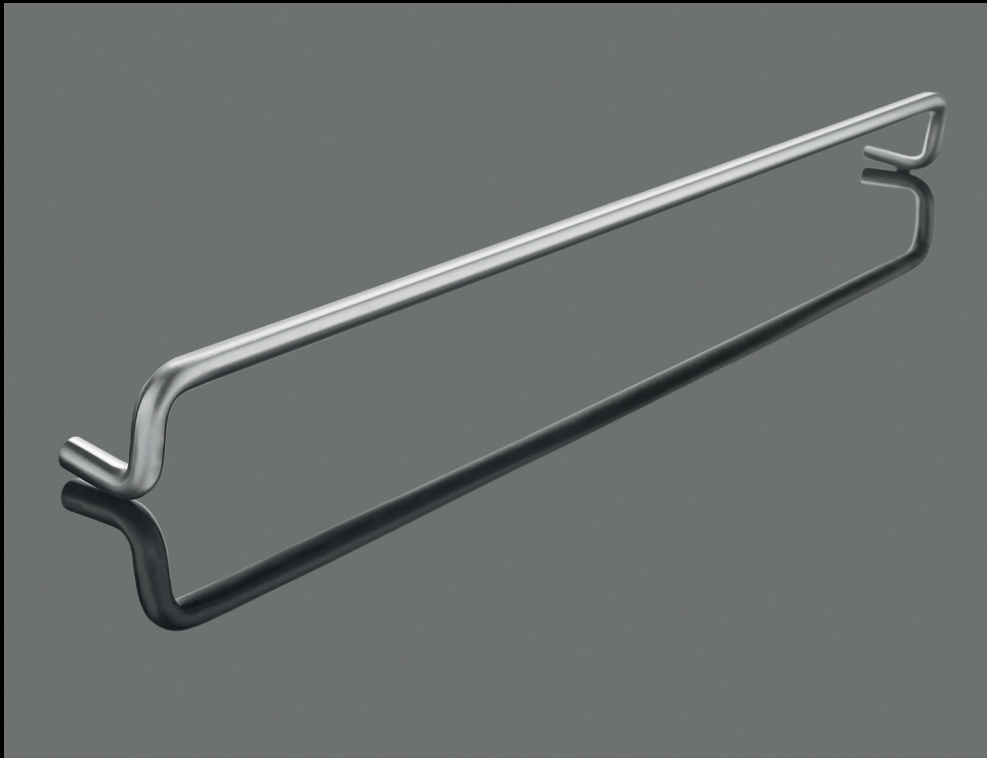

Dørhanke forkrøppet Ø14mm



Beskrivelse

Gevind M8 cc 125mm
 Gevind M8 cc 300mm
 Gevind M8 cc 650mm

Gevind M8 cc 0-300mm
 Gevind M8 cc 301-400mm
 Gevind M8 cc 401-500mm
 Gevind M8 cc 501-600mm
 Gevind M8 cc 601-700mm
 Gevind M8 cc 701-800mm
 Gevind M8 cc 801-900mm
 Gevind M8 cc 901-1000mm
 Gevind M8 cc 1001-1100mm
 Gevind M8 cc 1101-1200mm
 Gevind M8 cc 1201-1300mm
 Gevind M8 cc 1301-1400mm
 Gevind M8 cc 1401-1500mm
 Gevind M8 cc 1501-1600mm
 Gevind M8 cc 1601-1700mm
 Gevind M8 cc 1701-1800mm
 Gevind M8 cc 1801-1900mm
 Gevind M8 cc 1901-2000mm

Bøsning cc 125mm
 Bøsning cc 300mm
 Bøsning cc 650mm

Bøsning cc 0-300mm
 Bøsning cc 301-400mm
 Bøsning cc 401-500mm
 Bøsning cc 501-600mm
 Bøsning cc 601-700mm
 Bøsning cc 701-800mm
 Bøsning cc 801-900mm
 Bøsning cc 901-1000mm
 Bøsning cc 1001-1100mm
 Bøsning cc 1101-1200mm
 Bøsning cc 1201-1300mm
 Bøsning cc 1301-1400mm
 Bøsning cc 1401-1500mm
 Bøsning cc 1501-1600mm
 Bøsning cc 1601-1700mm
 Bøsning cc 1701-1800mm
 Bøsning cc 1801-1900mm
 Bøsning cc 1901-2000mm

Varenummer

14.4032.02.127
 14.4032.02.305
 14.4032.02.658

14.4032.02.704
 14.4032.02.712
 14.4032.02.721
 14.4032.02.739
 14.4032.02.747
 14.4032.02.755
 14.4032.02.764
 14.4032.02.777
 14.4032.02.785
 14.4032.02.793
 14.4032.02.807
 14.4032.02.815
 14.4032.02.823
 14.4032.02.837
 14.4032.02.845
 14.4032.02.853
 14.4032.02.865
 14.4032.02.873

14.4034.02.126
 14.4034.02.304
 14.4034.02.657

14.4034.02.703
 14.4034.02.711
 14.4034.02.720
 14.4034.02.738
 14.4034.02.746
 14.4034.02.754
 14.4034.02.763
 14.4034.02.776
 14.4034.02.784
 14.4034.02.792
 14.4034.02.806
 14.4034.02.814
 14.4034.02.822
 14.4034.02.836
 14.4034.02.844
 14.4034.02.852
 14.4034.02.864
 14.4034.02.872

Dørhanke lige Ø19mm

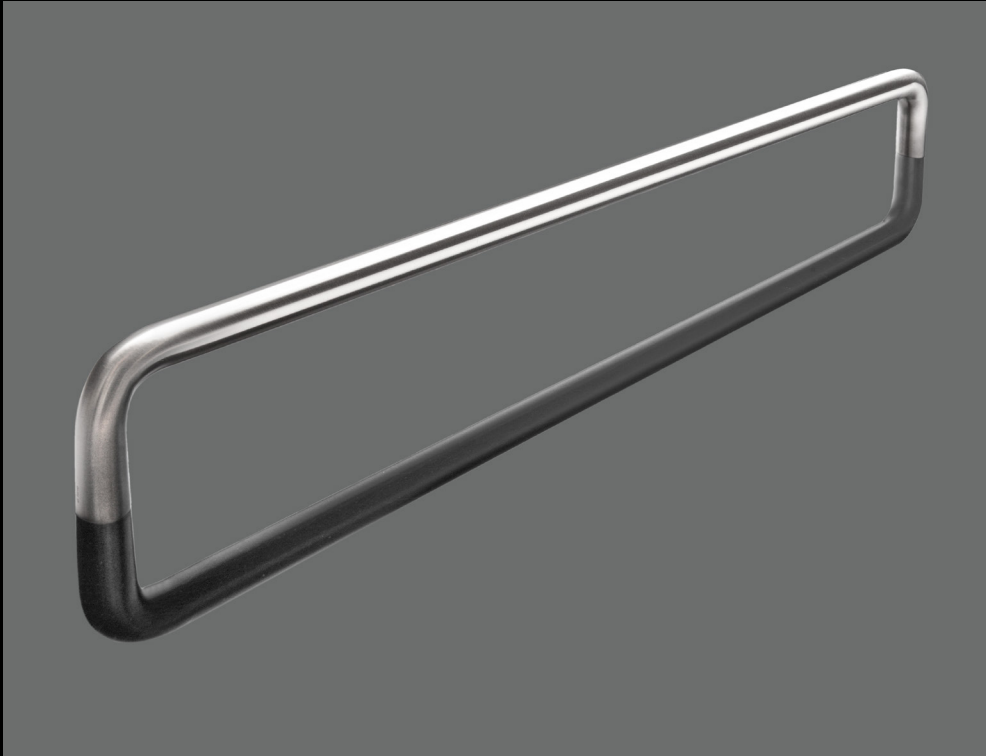

Dørhanke lige Ø19mm

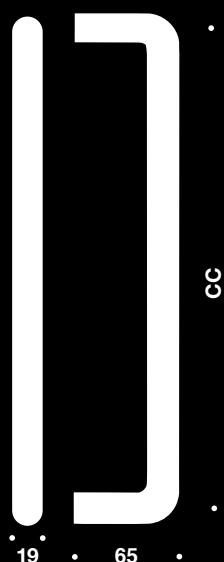

Beskrivelse	Varenummer
Gevind M8 cc 125mm	14.4212.02.126
Gevind M8 cc 200mm	14.4212.02.207
Gevind M8 cc 300mm	14.4212.02.304
Gevind M8 cc 400mm	14.4212.02.405
Gevind M8 cc 450mm	14.4212.02.450
Gevind M8 cc 650mm	14.4212.02.657
Gevind M8 cc 0-300mm	14.4212.02.703
Gevind M8 cc 301-400mm	14.4212.02.711
Gevind M8 cc 401-500mm	14.4212.02.720
Gevind M8 cc 501-600mm	14.4212.02.738
Gevind M8 cc 601-700mm	14.4212.02.746
Gevind M8 cc 701-800mm	14.4212.02.754
Gevind M8 cc 801-900mm	14.4212.02.762
Gevind M8 cc 901-1000mm	14.4212.02.771
Gevind M8 cc 1001-1100mm	14.4212.02.789
Gevind M8 cc 1101-1200mm	14.4212.02.797
Gevind M8 cc 1201-1300mm	14.4212.02.801
Gevind M8 cc 1301-1400mm	14.4212.02.819
Gevind M8 cc 1401-1500mm	14.4212.02.827
Gevind M8 cc 1501-1600mm	14.4212.02.835
Gevind M8 cc 1601-1700mm	14.4212.02.843
Gevind M8 cc 1701-1800mm	14.4212.02.851
Gevind M8 cc 1801-1900mm	14.4212.02.860
Gevind M8 cc 1901-2000mm	14.4212.02.878
Bøsning cc 125mm	14.4214.02.125
Bøsning cc 200mm	14.4214.02.206
Bøsning cc 300mm	14.4214.02.303
Bøsning cc 400mm	14.4214.02.404
Bøsning cc 450mm	14.4214.02.450
Bøsning cc 650mm	14.4214.02.656
Bøsning cc 0-300mm	14.4214.02.702
Bøsning cc 301-400mm	14.4214.02.711
Bøsning cc 401-500mm	14.4214.02.729
Bøsning cc 501-600mm	14.4214.02.737
Bøsning cc 601-700mm	14.4214.02.745
Bøsning cc 701-800mm	14.4214.02.753
Bøsning cc 801-900mm	14.4214.02.761
Bøsning cc 901-1000mm	14.4214.02.770
Bøsning cc 1001-1100mm	14.4214.02.788
Bøsning cc 1101-1200mm	14.4214.02.796
Bøsning cc 1201-1300mm	14.4214.02.800
Bøsning cc 1301-1400mm	14.4214.02.818
Bøsning cc 1401-1500mm	14.4214.02.826
Bøsning cc 1501-1600mm	14.4214.02.834
Bøsning cc 1601-1700mm	14.4214.02.842
Bøsning cc 1701-1800mm	14.4214.02.851
Bøsning cc 1801-1900mm	14.4214.02.869
Bøsning cc 1901-2000mm	14.4214.02.877
Gevind M8/bøsning cc 300mm	14.4218.02.301
Gevind M8/bøsning cc 650mm	14.4218.02.654

Vertikal/horisontal dørhank m/grisetrynebolt

Foto på vej

Vertikal/horisontal dørhank m/grisetrynebolt

Beskrivelse	Varenummer
Sæt 1	
x1 300mm horisontal	14.4212.02.304
x1 650mm vertikal	14.4218.02.654
x1	14.4915.92.380
x3	14.4965.00.301
x2	14.4920.02.306
Sæt 2	
x1 650mm horisontal	14.4212.02.657
x1 650mm vertikal	14.4218.02.654
x1	14.4915.92.380
x3	14.4965.00.301
x2	14.4920.02.306
Sæt 3	
x1 300mm horisontal	14.4212.02.304
x1 300mm vertikal	14.4218.02.301
x1	14.4915.92.380
x3	14.4965.00.301
x2	14.4920.02.306
Sæt 4	
x1 500mm horisontal	14.4212.02.720
x1 300mm vertikal	14.4218.02.301
x1	14.4915.92.380
x3	14.4965.00.301
x2	14.4920.02.306

Dørhanke forkrøppet Ø19mm

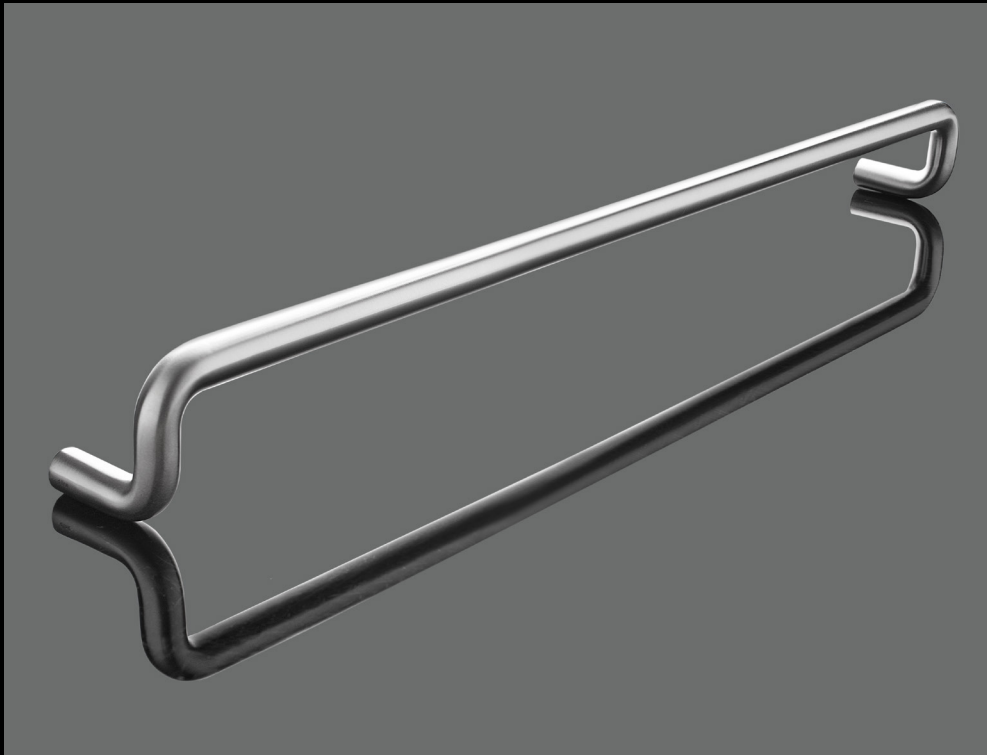

Dørhanke forkrøppet Ø19mm



Beskrivelse

Gevind M8 cc 125mm
 Gevind M8 cc 300mm
 Gevind M8 cc 400mm
 Gevind M8 cc 650mm

Gevind M8 cc 0-300mm
 Gevind M8 cc 301-400mm
 Gevind M8 cc 401-500mm
 Gevind M8 cc 501-600mm
 Gevind M8 cc 601-700mm
 Gevind M8 cc 701-800mm
 Gevind M8 cc 801-900mm
 Gevind M8 cc 901-1000mm
 Gevind M8 cc 1001-1100mm
 Gevind M8 cc 1101-1200mm
 Gevind M8 cc 1201-1300mm
 Gevind M8 cc 1301-1400mm
 Gevind M8 cc 1401-1500mm
 Gevind M8 cc 1501-1600mm
 Gevind M8 cc 1601-1700mm
 Gevind M8 cc 1701-1800mm
 Gevind M8 cc 1801-1900mm
 Gevind M8 cc 1901-2000mm

Bøsning cc 125mm
 Bøsning cc 300mm
 Bøsning cc 400mm
 Bøsning cc 650mm

Bøsning cc 0-300mm
 Bøsning cc 301-400mm
 Bøsning cc 401-500mm
 Bøsning cc 501-600mm
 Bøsning cc 601-700mm
 Bøsning cc 701-800mm
 Bøsning cc 801-900mm
 Bøsning cc 901-1000mm
 Bøsning cc 1001-1100mm
 Bøsning cc 1101-1200mm
 Bøsning cc 1201-1300mm
 Bøsning cc 1301-1400mm
 Bøsning cc 1401-1500mm
 Bøsning cc 1501-1600mm
 Bøsning cc 1601-1700mm
 Bøsning cc 1701-1800mm
 Bøsning cc 1801-1900mm
 Bøsning cc 1901-2000mm

Varenummer

14.4232.02.123
 14.4232.02.301
 14.4232.02.405
 14.4232.02.654

14.4232.02.701
 14.4232.02.719
 14.4232.02.727
 14.4232.02.735
 14.4232.02.743
 14.4232.02.751
 14.4232.02.760
 14.4232.02.778
 14.4232.02.781
 14.4232.02.791
 14.4232.02.803
 14.4232.02.815
 14.4232.02.827
 14.4232.02.839
 14.4232.02.841
 14.4232.02.853
 14.4232.02.865
 14.4232.02.877

14.4234.02.122
 14.4234.02.301
 14.4234.02.404
 14.4234.02.653

14.4234.02.700
 14.4234.02.718
 14.4234.02.726
 14.4234.02.734
 14.4234.02.742
 14.4234.02.751
 14.4234.02.769
 14.4234.02.777
 14.4234.02.785
 14.4234.02.793
 14.4234.02.801
 14.4234.02.813
 14.4234.02.825
 14.4234.02.837
 14.4234.02.849
 14.4234.02.851
 14.4234.02.863
 14.4234.02.875

Dørhanke lige Ø25mm

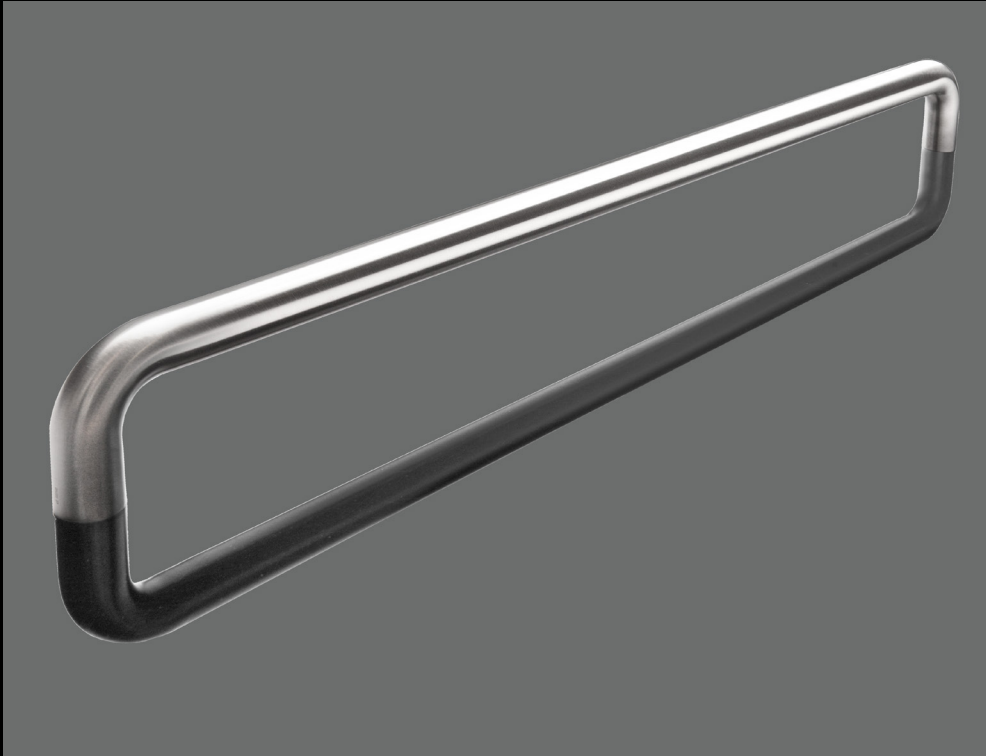

Dørhanke lige Ø25mm

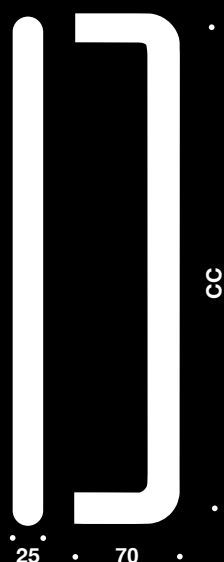

Beskrivelse	Varenummer
Gevind M10 cc 300mm	14.4412.02.301
Gevind M10 cc 650mm	14.4412.02.653
Gevind M10 cc 0-300mm	14.4412.02.700
Gevind M10 cc 301-400mm	14.4412.02.718
Gevind M10 cc 401-500mm	14.4412.02.726
Gevind M10 cc 501-600mm	14.4412.02.734
Gevind M10 cc 601-700mm	14.4412.02.742
Gevind M10 cc 701-800mm	14.4412.02.751
Gevind M10 cc 801-900mm	14.4412.02.769
Gevind M10 cc 901-1000mm	14.4412.02.777
Gevind M10 cc 1001-1100mm	14.4412.02.785
Gevind M10 cc 1101-1200mm	14.4412.02.793
Gevind M10 cc 1201-1300mm	14.4412.02.807
Gevind M10 cc 1301-1400mm	14.4412.02.815
Gevind M10 cc 1401-1500mm	14.4412.02.823
Gevind M10 cc 1501-1600mm	14.4412.02.831
Gevind M10 cc 1601-1700mm	14.4412.02.840
Gevind M10 cc 1701-1800mm	14.4412.02.858
Gevind M10 cc 1801-1900mm	14.4412.02.866
Gevind M10 cc 1901-2000mm	14.4412.02.874
Bøsning cc 300mm	14.4414.02.300
Bøsning cc 650mm	14.4414.02.652
Bøsning cc 0-300mm	14.4414.02.709
Bøsning cc 301-400mm	14.4414.02.717
Bøsning cc 401-500mm	14.4414.02.725
Bøsning cc 501-600mm	14.4414.02.733
Bøsning cc 601-700mm	14.4414.02.741
Bøsning cc 701-800mm	14.4414.02.750
Bøsning cc 801-900mm	14.4414.02.768
Bøsning cc 901-1000mm	14.4414.02.776
Bøsning cc 1001-1100mm	14.4414.02.784
Bøsning cc 1101-1200mm	14.4414.02.792
Bøsning cc 1201-1300mm	14.4414.02.806
Bøsning cc 1301-1400mm	14.4414.02.814
Bøsning cc 1401-1500mm	14.4414.02.822
Bøsning cc 1501-1600mm	14.4414.02.831
Bøsning cc 1601-1700mm	14.4414.02.849
Bøsning cc 1701-1800mm	14.4414.02.857
Bøsning cc 1801-1900mm	14.4414.02.865
Bøsning cc 1901-2000mm	14.4414.02.873
Gevind M10/bøsning cc 300mm	14.4418.02.308
Gevind M10/bøsning cc 650mm	14.4418.02.651

Vertikal/horisontal dørhank m/grisetrynebolt

Foto på vej

Vertikal/horisontal dørhank m/grisetrynebolt

Beskrivelse	Varenummer
Sæt 1	
x1 300mm horisontal	14.4412.02.301
x1 650mm vertikal	14.4418.02.651
x1	14.4915.92.380
x3	14.4965.00.351
x2	14.4922.02.305
Sæt 2	
x1 650mm horisontal	14.4412.02.653
x1 650mm vertikal	14.4418.02.651
x1	14.4915.92.380
x3	14.4965.00.351
x2	14.4922.02.305
Sæt 3	
x1 300mm horisontal	14.4412.02.301
x1 300mm vertikal	14.4418.02.308
x1	14.4915.92.380
x3	14.4965.00.351
x2	14.4922.02.305
Sæt 4	
x1 500mm horisontal	14.4412.02.726
x1 650mm vertikal	14.4218.02.654
x1	14.4915.92.380
x3	14.4965.00.301
x2	14.4920.02.306

Dørhanke forkrøppet Ø25mm

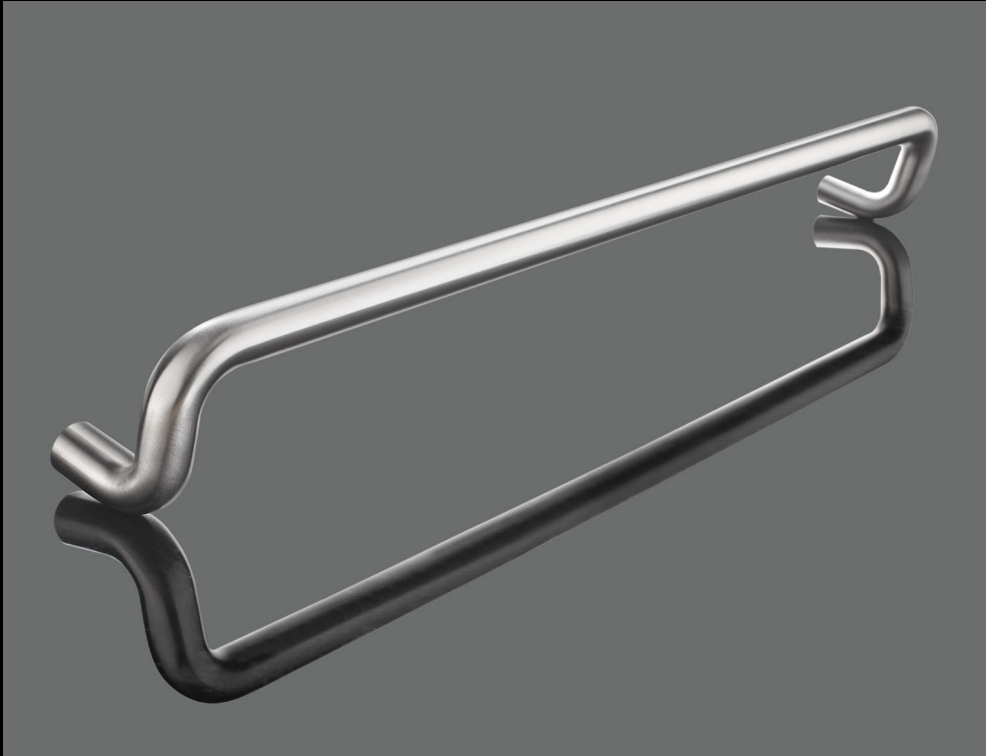

Dørhanke forkrøppet Ø25mm



Beskrivelse

Gevind M10 cc 300mm
Gevind M10 cc 650mm

Gevind M10 cc 0-300mm
Gevind M10 cc 301-400mm
Gevind M10 cc 401-500mm
Gevind M10 cc 501-600mm
Gevind M10 cc 601-700mm
Gevind M10 cc 701-800mm
Gevind M10 cc 801-900mm
Gevind M10 cc 901-1000mm
Gevind M10 cc 1001-1100mm
Gevind M10 cc 1101-1200mm
Gevind M10 cc 1201-1300mm
Gevind M10 cc 1301-1400mm
Gevind M10 cc 1401-1500mm
Gevind M10 cc 1501-1600mm
Gevind M10 cc 1601-1700mm
Gevind M10 cc 1701-1800mm
Gevind M10 cc 1801-1900mm
Gevind M10 cc 1901-2000mm

Bøsning cc 300mm
Bøsning cc 650mm

Bøsning cc 0-300mm
Bøsning cc 301-400mm
Bøsning cc 401-500mm
Bøsning cc 501-600mm
Bøsning cc 601-700mm
Bøsning cc 701-800mm
Bøsning cc 801-900mm
Bøsning cc 901-1000mm
Bøsning cc 1001-1100mm
Bøsning cc 1101-1200mm
Bøsning cc 1201-1300mm
Bøsning cc 1301-1400mm
Bøsning cc 1401-1500mm
Bøsning cc 1501-1600mm
Bøsning cc 1601-1700mm
Bøsning cc 1701-1800mm
Bøsning cc 1801-1900mm
Bøsning cc 1901-2000mm

Varenummer

14.4432.02.308
14.4432.02.651

14.4432.02.707
14.4432.02.715
14.4432.02.723
14.4432.02.731
14.4432.02.740
14.4432.02.758
14.4432.02.766
14.4432.02.774
14.4432.02.787
14.4432.02.799
14.4432.02.801
14.4432.02.813
14.4432.02.825
14.4432.02.837
14.4432.02.849
14.4432.02.851
14.4432.02.863
14.4432.02.875

14.4434.02.307
14.4434.02.650

14.4434.02.706
14.4434.02.714
14.4434.02.722
14.4434.02.731
14.4434.02.749
14.4434.02.757
14.4434.02.765
14.4434.02.773
14.4434.02.786
14.4434.02.798
14.4434.02.800
14.4434.02.812
14.4434.02.824
14.4434.02.836
14.4434.02.848
14.4434.02.850
14.4434.02.862
14.4434.02.874

Dørhanke lige Ø32mm



Dørhanke lige Ø32mm

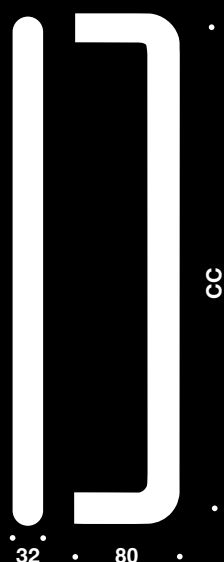

Beskrivelse	Varenummer
Gevind M12 cc 300mm	14.4612.02.307
Gevind M12 cc 650mm	14.4612.02.650
Gevind M12 cc 0-300mm	14.4612.02.706
Gevind M12 cc 301-400mm	14.4612.02.714
Gevind M12 cc 401-500mm	14.4612.02.722
Gevind M12 cc 501-600mm	14.4612.02.731
Gevind M12 cc 601-700mm	14.4612.02.749
Gevind M12 cc 701-800mm	14.4612.02.757
Gevind M12 cc 801-900mm	14.4612.02.765
Gevind M12 cc 901-1000mm	14.4612.02.773
Gevind M12 cc 1001-1100mm	14.4612.02.781
Gevind M12 cc 1101-1200mm	14.4612.02.790
Gevind M12 cc 1201-1300mm	14.4612.02.803
Gevind M12 cc 1301-1400mm	14.4612.02.811
Gevind M12 cc 1401-1500mm	14.4612.02.820
Gevind M12 cc 1501-1600mm	14.4612.02.838
Gevind M12 cc 1601-1700mm	14.4612.02.846
Gevind M12 cc 1701-1800mm	14.4612.02.854
Gevind M12 cc 1801-1900mm	14.4612.02.862
Gevind M12 cc 1901-2000mm	14.4612.02.871
Gevind M12 cc 2001-2100mm	14.4612.02.889
Gevind M12 cc 2101-2200mm	14.4612.02.897
Gevind M12 cc 2201-2300mm	14.4612.02.901
Gevind M12 cc 2301-2400mm	14.4612.02.919
Gevind M12 cc 2401-2500mm	14.4612.02.927
Gevind M12 cc 2501-2600mm	14.4612.02.935
Gevind M12 cc 2601-2700mm	14.4612.02.943
Gevind M12 cc 2701-2800mm	14.4612.02.951
Gevind M12 cc 2801-2900mm	14.4612.02.969
Gevind M12 cc 2901-3000mm	14.4612.02.977
Bøsning cc 300mm	14.4614.02.306
Bøsning cc 650mm	14.4614.02.659
Bøsning cc 0-300mm	14.4614.02.705
Bøsning cc 301-400mm	14.4614.02.713
Bøsning cc 401-500mm	14.4614.02.721
Bøsning cc 501-600mm	14.4614.02.730
Bøsning cc 601-700mm	14.4614.02.748
Bøsning cc 701-800mm	14.4614.02.756
Bøsning cc 801-900mm	14.4614.02.764
Bøsning cc 901-1000mm	14.4614.02.772
Bøsning cc 1001-1100mm	14.4614.02.781
Bøsning cc 1101-1200mm	14.4614.02.799
Bøsning cc 1201-1300mm	14.4614.02.802
Bøsning cc 1301-1400mm	14.4614.02.811
Bøsning cc 1401-1500mm	14.4614.02.829
Bøsning cc 1501-1600mm	14.4614.02.837
Bøsning cc 1601-1700mm	14.4614.02.845
Bøsning cc 1701-1800mm	14.4614.02.853
Bøsning cc 1801-1900mm	14.4614.02.861
Bøsning cc 1901-2000mm	14.4614.02.870
Bøsning cc 2001-2100mm	14.4614.02.888
Bøsning cc 2101-2200mm	14.4614.02.896
Bøsning cc 2201-2300mm	14.4614.02.900
Bøsning cc 2301-2400mm	14.4614.02.918
Bøsning cc 2401-2500mm	14.4614.02.926
Bøsning cc 2501-2600mm	14.4614.02.934
Bøsning cc 2601-2700mm	14.4614.02.942
Bøsning cc 2701-2800mm	14.4614.02.950
Bøsning cc 2801-2900mm	14.4614.02.968
Bøsning cc 2901-3000mm	14.4614.02.976
Gevind M12/bøsning cc 300mm	14.4618.02.304
Gevind M12/bøsning cc 650mm	14.4618.02.657

Dørhanke forkrøppet Ø32mm

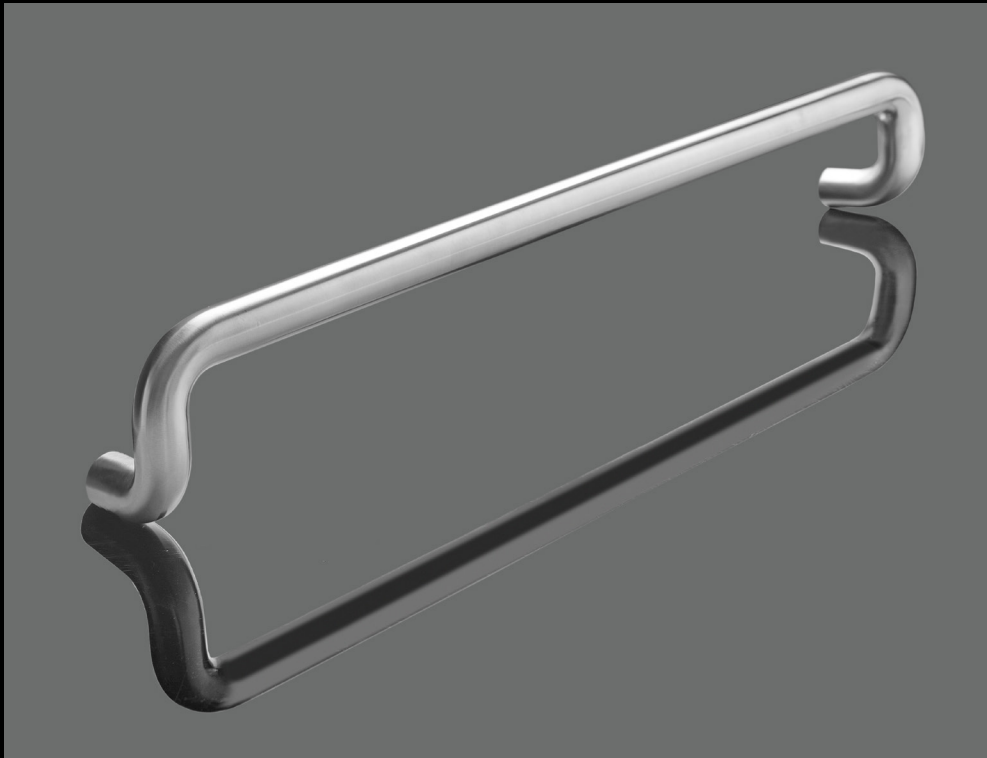

Dørhanke forkrøppet Ø32mm



Beskrivelse

Gevind M12 cc 300mm
Gevind M12 cc 650mm

Gevind M12 cc 0-300mm
Gevind M12 cc 301-400mm
Gevind M12 cc 401-500mm
Gevind M12 cc 501-600mm
Gevind M12 cc 601-700mm
Gevind M12 cc 701-800mm
Gevind M12 cc 801-900mm
Gevind M12 cc 901-1000mm
Gevind M12 cc 1001-1100mm
Gevind M12 cc 1101-1200mm
Gevind M12 cc 1201-1300mm
Gevind M12 cc 1301-1400mm
Gevind M12 cc 1401-1500mm
Gevind M12 cc 1501-1600mm
Gevind M12 cc 1601-1700mm
Gevind M12 cc 1701-1800mm
Gevind M12 cc 1801-1900mm
Gevind M12 cc 1901-2000mm
Gevind M12 cc 2001-2100mm
Gevind M12 cc 2101-2200mm
Gevind M12 cc 2201-2300mm
Gevind M12 cc 2301-2400mm
Gevind M12 cc 2401-2500mm
Gevind M12 cc 2501-2600mm
Gevind M12 cc 2601-2700mm
Gevind M12 cc 2701-2800mm
Gevind M12 cc 2801-2900mm
Gevind M12 cc 2901-3000mm

Bøsning cc 300mm
Bøsning cc 650mm

Bøsning cc 0-300mm
Bøsning cc 301-400mm
Bøsning cc 401-500mm
Bøsning cc 501-600mm
Bøsning cc 601-700mm
Bøsning cc 701-800mm
Bøsning cc 801-900mm
Bøsning cc 901-1000mm
Bøsning cc 1001-1100mm
Bøsning cc 1101-1200mm
Bøsning cc 1201-1300mm
Bøsning cc 1301-1400mm
Bøsning cc 1401-1500mm
Bøsning cc 1501-1600mm
Bøsning cc 1601-1700mm
Bøsning cc 1701-1800mm
Bøsning cc 1801-1900mm
Bøsning cc 1901-2000mm
Bøsning cc 2001-2100mm
Bøsning cc 2101-2200mm
Bøsning cc 2201-2300mm
Bøsning cc 2301-2400mm
Bøsning cc 2401-2500mm
Bøsning cc 2501-2600mm
Bøsning cc 2601-2700mm
Bøsning cc 2701-2800mm
Bøsning cc 2801-2900mm
Bøsning cc 2901-3000mm

Varenummer

14.4632.02.304
14.4632.02.657

14.4632.02.703
14.4632.02.711
14.4632.02.720
14.4632.02.738
14.4632.02.746
14.4632.02.754
14.4632.02.762
14.4632.02.779
14.4632.02.787
14.4632.02.795
14.4632.02.801
14.4632.02.813
14.4632.02.825
14.4632.02.837
14.4632.02.849
14.4632.02.851
14.4632.02.863
14.4632.02.875
14.4632.02.887
14.4632.02.899
14.4632.02.901
14.4632.02.913
14.4632.02.925
14.4632.02.937
14.4632.02.949
14.4632.02.951
14.4632.02.963
14.4632.02.975

14.4634.02.303
14.4634.02.656

14.4634.02.702
14.4634.02.711
14.4634.02.729
14.4634.02.737
14.4634.02.745
14.4634.02.753
14.4634.02.761
14.4634.02.778
14.4634.02.786
14.4634.02.794
14.4634.02.800
14.4634.02.812
14.4634.02.824
14.4634.02.836
14.4634.02.848
14.4634.02.850
14.4634.02.862
14.4634.02.874
14.4634.02.886
14.4634.02.898
14.4634.02.900
14.4634.02.912
14.4634.02.924
14.4634.02.936
14.4634.02.948
14.4634.02.950
14.4634.02.962
14.4634.02.974

Dørhanke lige FF Ø14 mm



Dørhanke lige FF Ø14 mm



Beskrivelse	Varenummer
Gevind M8 cc 125mm	14.4022.02.125
Gevind M8 cc 300mm	14.4022.02.300
Gevind M8 cc 650mm	14.4022.02.650
Gevind M8 cc 0-300mm	14.4022.02.700
Gevind M8 cc 301-400mm	14.4022.02.710
Gevind M8 cc 401-500mm	14.4022.02.720
Gevind M8 cc 501-600mm	14.4022.02.730
Gevind M8 cc 601-700mm	14.4022.02.740
Gevind M8 cc 701-800mm	14.4022.02.750
Gevind M8 cc 801-900mm	14.4022.02.760
Gevind M8 cc 901-1000mm	14.4022.02.770
Gevind M8 cc 1001-1100mm	14.4022.02.780
Gevind M8 cc 1101-1200mm	14.4022.02.790
Gevind M8 cc 1201-1300mm	14.4022.02.800
Gevind M8 cc 1301-1400mm	14.4022.02.810
Gevind M8 cc 1401-1500mm	14.4022.02.820
Gevind M8 cc 1501-1600mm	14.4022.02.830
Gevind M8 cc 1601-1700mm	14.4022.02.840
Gevind M8 cc 1701-1800mm	14.4022.02.850
Gevind M8 cc 1801-1900mm	14.4022.02.860
Gevind M8 cc 1901-2000mm	14.4022.02.870
Bøsning cc 125mm	14.4024.02.125
Bøsning cc 300mm	14.4024.02.300
Bøsning cc 650mm	14.4024.02.650
Bøsning cc 0-300mm	14.4024.02.700
Bøsning cc 301-400mm	14.4024.02.710
Bøsning cc 401-500mm	14.4024.02.720
Bøsning cc 501-600mm	14.4024.02.730
Bøsning cc 601-700mm	14.4024.02.740
Bøsning cc 701-800mm	14.4024.02.750
Bøsning cc 801-900mm	14.4024.02.760
Bøsning cc 901-1000mm	14.4024.02.770
Bøsning cc 1001-1100mm	14.4024.02.780
Bøsning cc 1101-1200mm	14.4024.02.790
Bøsning cc 1201-1300mm	14.4024.02.800
Bøsning cc 1301-1400mm	14.4024.02.810
Bøsning cc 1401-1500mm	14.4024.02.820
Bøsning cc 1501-1600mm	14.4024.02.830
Bøsning cc 1601-1700mm	14.4024.02.840
Bøsning cc 1701-1800mm	14.4024.02.850
Bøsning cc 1801-1900mm	14.4024.02.860
Bøsning cc 1901-2000mm	14.4024.02.870

Dørhanke lige FF Ø19 mm



Dørhanke lige FF Ø19 mm



Beskrivelse

Gevind M8 cc 125mm
 Gevind M8 cc 200mm
 Gevind M8 cc 300mm
 Gevind M8 cc 400mm
 Gevind M8 cc 650mm
 Gevind M8 cc 0-300mm
 Gevind M8 cc 301-400mm
 Gevind M8 cc 401-500mm
 Gevind M8 cc 501-600mm
 Gevind M8 cc 601-700mm
 Gevind M8 cc 701-800mm
 Gevind M8 cc 801-900mm
 Gevind M8 cc 901-1000mm
 Gevind M8 cc 1001-1100mm
 Gevind M8 cc 1101-1200mm
 Gevind M8 cc 1201-1300mm
 Gevind M8 cc 1301-1400mm
 Gevind M8 cc 1401-1500mm
 Gevind M8 cc 1501-1600mm
 Gevind M8 cc 1601-1700mm
 Gevind M8 cc 1701-1800mm
 Gevind M8 cc 1801-1900mm
 Gevind M8 cc 1901-2000mm

Varenummer

14.4222.02.125
 14.4222.02.200
 14.4222.02.300
 14.4222.02.400
 14.4222.02.650
 14.4222.02.700
 14.4222.02.710
 14.4222.02.720
 14.4222.02.730
 14.4222.02.740
 14.4222.02.750
 14.4222.02.760
 14.4222.02.770
 14.4222.02.780
 14.4222.02.790
 14.4222.02.800
 14.4222.02.810
 14.4222.02.820
 14.4222.02.830
 14.4222.02.840
 14.4222.02.850
 14.4222.02.860
 14.4222.02.870

Bøsning cc 125mm
 Bøsning cc 200mm
 Bøsning cc 300mm
 Bøsning cc 400mm
 Bøsning cc 650mm
 Bøsning cc 0-300mm
 Bøsning cc 301-400mm
 Bøsning cc 401-500mm
 Bøsning cc 501-600mm
 Bøsning cc 601-700mm
 Bøsning cc 701-800mm
 Bøsning cc 801-900mm
 Bøsning cc 901-1000mm
 Bøsning cc 1001-1100mm
 Bøsning cc 1101-1200mm
 Bøsning cc 1201-1300mm
 Bøsning cc 1301-1400mm
 Bøsning cc 1401-1500mm
 Bøsning cc 1501-1600mm
 Bøsning cc 1601-1700mm
 Bøsning cc 1701-1800mm
 Bøsning cc 1801-1900mm
 Bøsning cc 1901-2000mm

14.4224.02.125
 14.4224.02.200
 14.4224.02.300
 14.4224.02.400
 14.4224.02.650
 14.4224.02.700
 14.4224.02.710
 14.4224.02.720
 14.4224.02.730
 14.4224.02.740
 14.4224.02.750
 14.4224.02.760
 14.4224.02.770
 14.4224.02.780
 14.4224.02.790
 14.4224.02.800
 14.4224.02.810
 14.4224.02.820
 14.4224.02.830
 14.4224.02.840
 14.4224.02.850
 14.4224.02.860
 14.4224.02.870

Gevind M8/Bøsning cc 300mm
 Gevind M8/Bøsning cc 650mm

14.4228.02.300
 14.4228.02.650

Dørhanke lige FF Ø25 mm



Dørhanke lige FF Ø25 mm

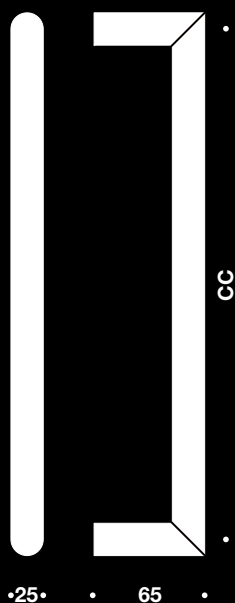

Beskrivelse	Varenummer
Gevind M10 cc 300mm	14.4422.02.300
Gevind M10 cc 650mm	14.4422.02.650
Gevind M10 cc 0-300mm	14.4422.02.700
Gevind M10 cc 301-400mm	14.4422.02.710
Gevind M10 cc 401-500mm	14.4422.02.720
Gevind M10 cc 501-600mm	14.4422.02.730
Gevind M10 cc 601-700mm	14.4422.02.740
Gevind M10 cc 701-800mm	14.4422.02.750
Gevind M10 cc 801-900mm	14.4422.02.760
Gevind M10 cc 901-1000mm	14.4422.02.770
Gevind M10 cc 1001-1100mm	14.4422.02.780
Gevind M10 cc 1101-1200mm	14.4422.02.790
Gevind M10 cc 1201-1300mm	14.4422.02.800
Gevind M10 cc 1301-1400mm	14.4422.02.810
Gevind M10 cc 1401-1500mm	14.4422.02.820
Gevind M10 cc 1501-1600mm	14.4422.02.830
Gevind M10 cc 1601-1700mm	14.4422.02.840
Gevind M10 cc 1701-1800mm	14.4422.02.850
Gevind M10 cc 1801-1900mm	14.4422.02.860
Gevind M10 cc 1901-2000mm	14.4422.02.870
Bøsning cc 300mm	14.4424.02.300
Bøsning cc 650mm	14.4424.02.650
Bøsning cc 0-300mm	14.4424.02.700
Bøsning cc 301-400mm	14.4424.02.710
Bøsning cc 401-500mm	14.4424.02.720
Bøsning cc 501-600mm	14.4424.02.730
Bøsning cc 601-700mm	14.4424.02.740
Bøsning cc 701-800mm	14.4424.02.750
Bøsning cc 801-900mm	14.4424.02.760
Bøsning cc 901-1000mm	14.4424.02.770
Bøsning cc 1001-1100mm	14.4424.02.780
Bøsning cc 1101-1200mm	14.4424.02.790
Bøsning cc 1201-1300mm	14.4424.02.800
Bøsning cc 1301-1400mm	14.4424.02.810
Bøsning cc 1401-1500mm	14.4424.02.820
Bøsning cc 1501-1600mm	14.4424.02.830
Bøsning cc 1601-1700mm	14.4424.02.840
Bøsning cc 1701-1800mm	14.4424.02.850
Bøsning cc 1801-1900mm	14.4424.02.860
Bøsning cc 1901-2000mm	14.4424.02.870
Gevind M10/Bøsning cc 300mm	14.4428.02.300
Gevind M10/Bøsning cc 650mm	14.4428.02.650

Dørhanke lige FF Ø32 mm



Dørhanke lige FF Ø32 mm



Beskrivelse

Gevind M12 cc 300mm
 Gevind M12 cc 650mm
 Gevind M12 cc 0-300mm
 Gevind M12 cc 301-400mm
 Gevind M12 cc 401-500mm
 Gevind M12 cc 501-600mm
 Gevind M12 cc 601-700mm
 Gevind M12 cc 701-800mm
 Gevind M12 cc 801-900mm
 Gevind M12 cc 901-1000mm
 Gevind M12 cc 1001-1100mm
 Gevind M12 cc 1101-1200mm
 Gevind M12 cc 1201-1300mm
 Gevind M12 cc 1301-1400mm
 Gevind M12 cc 1401-1500mm
 Gevind M12 cc 1501-1600mm
 Gevind M12 cc 1601-1700mm
 Gevind M12 cc 1701-1800mm
 Gevind M12 cc 1801-1900mm
 Gevind M12 cc 1901-2000mm
 Gevind M12 cc 2001-2100mm
 Gevind M12 cc 2101-2200mm
 Gevind M12 cc 2201-2300mm
 Gevind M12 cc 2301-2400mm
 Gevind M12 cc 2401-2500mm
 Gevind M12 cc 2501-2600mm
 Gevind M12 cc 2601-2700mm
 Gevind M12 cc 2701-2800mm
 Gevind M12 cc 2801-2900mm
 Gevind M12 cc 2901-3000mm

Varenummer

14.4622.02.300
 14.4622.02.650
 14.4622.02.700
 14.4622.02.710
 14.4622.02.720
 14.4622.02.730
 14.4622.02.740
 14.4622.02.750
 14.4622.02.760
 14.4622.02.770
 14.4622.02.780
 14.4622.02.790
 14.4622.02.800
 14.4622.02.810
 14.4622.02.820
 14.4622.02.830
 14.4622.02.840
 14.4622.02.850
 14.4622.02.860
 14.4622.02.870
 14.4622.02.880
 14.4622.02.890
 14.4622.02.900
 14.4622.02.910
 14.4622.02.920
 14.4622.02.930
 14.4622.02.940
 14.4622.02.950
 14.4622.02.960
 14.4622.02.970

Bøsning cc 300mm

14.4624.02.300

Bøsning cc 650mm

14.4624.02.650

Bøsning cc 0-300mm
 Bøsning cc 301-400mm
 Bøsning cc 401-500mm
 Bøsning cc 501-600mm
 Bøsning cc 601-700mm
 Bøsning cc 701-800mm
 Bøsning cc 801-900mm
 Bøsning cc 901-1000mm
 Bøsning cc 1001-1100mm
 Bøsning cc 1101-1200mm
 Bøsning cc 1201-1300mm
 Bøsning cc 1301-1400mm
 Bøsning cc 1401-1500mm
 Bøsning cc 1501-1600mm
 Bøsning cc 1601-1700mm
 Bøsning cc 1701-1800mm
 Bøsning cc 1801-1900mm
 Bøsning cc 1901-2000mm
 Bøsning cc 2001-2100mm
 Bøsning cc 2101-2200mm
 Bøsning cc 2201-2300mm
 Bøsning cc 2301-2400mm
 Bøsning cc 2401-2500mm
 Bøsning cc 2501-2600mm
 Bøsning cc 2601-2700mm
 Bøsning cc 2701-2800mm
 Bøsning cc 2801-2900mm
 Bøsning cc 2901-3000mm

14.4624.02.700
 14.4624.02.710
 14.4624.02.720
 14.4624.02.730
 14.4624.02.740
 14.4624.02.750
 14.4624.02.760
 14.4624.02.770
 14.4624.02.780
 14.4624.02.790
 14.4624.02.800
 14.4624.02.810
 14.4624.02.820
 14.4624.02.830
 14.4624.02.840
 14.4624.02.850
 14.4624.02.860
 14.4624.02.870
 14.4624.02.880
 14.4624.02.890
 14.4624.02.900
 14.4624.02.910
 14.4624.02.920
 14.4624.02.930
 14.4624.02.940
 14.4624.02.950
 14.4624.02.960
 14.4624.02.970

Gevind M12/Bøsning cc 300mm

14.4628.02.300

Gevind M12/Bøsning cc 650mm

14.4628.02.650

Dørhanke Ø20mm



Dørhanke Ø20mm

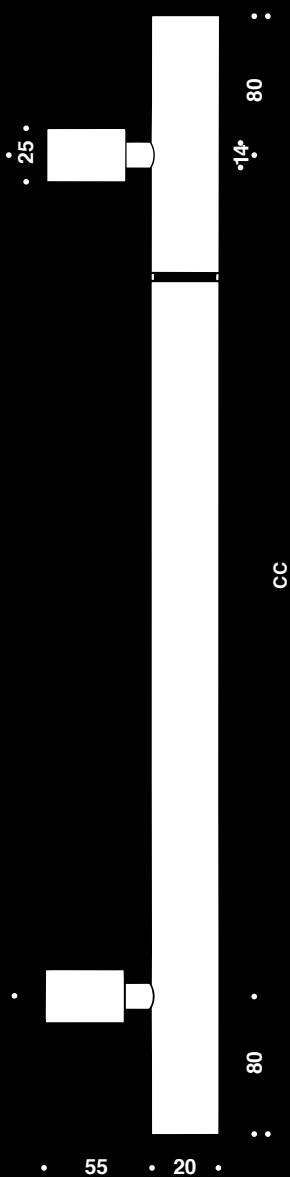

Beskrivelse

- Gevind M10 0-300mm
- Gevind M10 301-500mm
- Gevind M10 501-700mm
- Gevind M10 701-900mm
- Gevind M10 901-1100mm
- Gevind M10 1101-1300mm
- Gevind M10 1301-1500mm
- Gevind M10 1501-1600mm
- Gevind M10 1601-1700mm
- Gevind M10 1701-1800mm
- Gevind M10 1801-1900mm
- Gevind M10 1901-2000mm

Varenummer

- 14.4312.02.700
- 14.4312.02.712
- 14.4312.02.724
- 14.4312.02.736
- 14.4312.02.748
- 14.4312.02.750
- 14.4312.02.762
- 14.4312.02.774
- 14.4312.02.786
- 14.4312.02.798
- 14.4312.02.800
- 14.4312.02.812

- Bøsning 0-300mm
- Bøsning 301-500mm
- Bøsning 501-700mm
- Bøsning 701-900mm
- Bøsning 901-1100mm
- Bøsning 1101-1300mm
- Bøsning 1301-1500mm
- Bøsning 1501-1600mm
- Bøsning 1601-1700mm
- Bøsning 1701-1800mm
- Bøsning 1801-1900mm
- Bøsning 1901-2000mm

- 14.4314.02.701
- 14.4314.02.713
- 14.4314.02.725
- 14.4314.02.737
- 14.4314.02.749
- 14.4314.02.751
- 14.4314.02.763
- 14.4314.02.775
- 14.4314.02.787
- 14.4314.02.799
- 14.4314.02.801
- 14.4314.02.813

Hanke med andre dimensioner end her angivet, kan muligvis leveres. Kontakt kundeservice for mere information

Dørhanke Ø32mm



Dørhanke Ø32mm



Beskrivelse

- Gevind M12 500-700mm
- Gevind M12 701-900mm
- Gevind M12 901-1100mm
- Gevind M12 1101-1300mm
- Gevind M12 1301-1500mm
- Gevind M12 1501-1600mm
- Gevind M12 1601-1700mm
- Gevind M12 1701-1800mm
- Gevind M12 1801-1900mm
- Gevind M12 1901-2000mm
- Gevind M12 2001-2100mm
- Gevind M12 2101-2200mm
- Gevind M12 2201-2300mm
- Gevind M12 2301-2400mm
- Gevind M12 2401-2500mm
- Gevind M12 2501-2600mm
- Gevind M12 2601-2700mm
- Gevind M12 2701-2800mm
- Gevind M12 2801-2900mm
- Gevind M12 2901-3000mm

Varenummer

- 14.4612.02.010
- 14.4612.02.028
- 14.4612.02.036
- 14.4612.02.044
- 14.4612.02.052
- 14.4612.02.061
- 14.4612.02.079
- 14.4612.02.087
- 14.4612.02.095
- 14.4612.02.109
- 14.4612.02.117
- 14.4612.02.125
- 14.4612.02.133
- 14.4612.02.141
- 14.4612.02.150
- 14.4612.02.168
- 14.4612.02.170
- 14.4612.02.180
- 14.4612.02.190
- 14.4612.02.200

- Bøsning 500-700mm
- Bøsning 701-900mm
- Bøsning 901-1100mm
- Bøsning 1101-1300mm
- Bøsning 1301-1500mm
- Bøsning 1501-1600mm
- Bøsning 1601-1700mm
- Bøsning 1701-1800mm
- Bøsning 1801-1900mm
- Bøsning 1901-2000mm
- Bøsning 2001-2100mm
- Bøsning 2101-2200mm
- Bøsning 2201-2300mm
- Bøsning 2301-2400mm
- Bøsning 2401-2500mm
- Bøsning 2501-2600mm
- Bøsning 2601-2700mm
- Bøsning 2701-2800mm
- Bøsning 2801-2900mm
- Bøsning 2901-3000mm

- 14.4614.02.019
- 14.4614.02.027
- 14.4614.02.035
- 14.4614.02.043
- 14.4614.02.051
- 14.4614.02.060
- 14.4614.02.078
- 14.4614.02.086
- 14.4614.02.094
- 14.4614.02.108
- 14.4614.02.116
- 14.4614.02.124
- 14.4614.02.132
- 14.4614.02.141
- 14.4614.02.159
- 14.4614.02.167
- 14.4614.02.170
- 14.4614.02.180
- 14.4614.02.190
- 14.4614.02.200

Hanke med andre dimensioner end her angivet, kan muligvis leveres. Kontakt kundeservice for mere information

Dørhanke Ø38mm

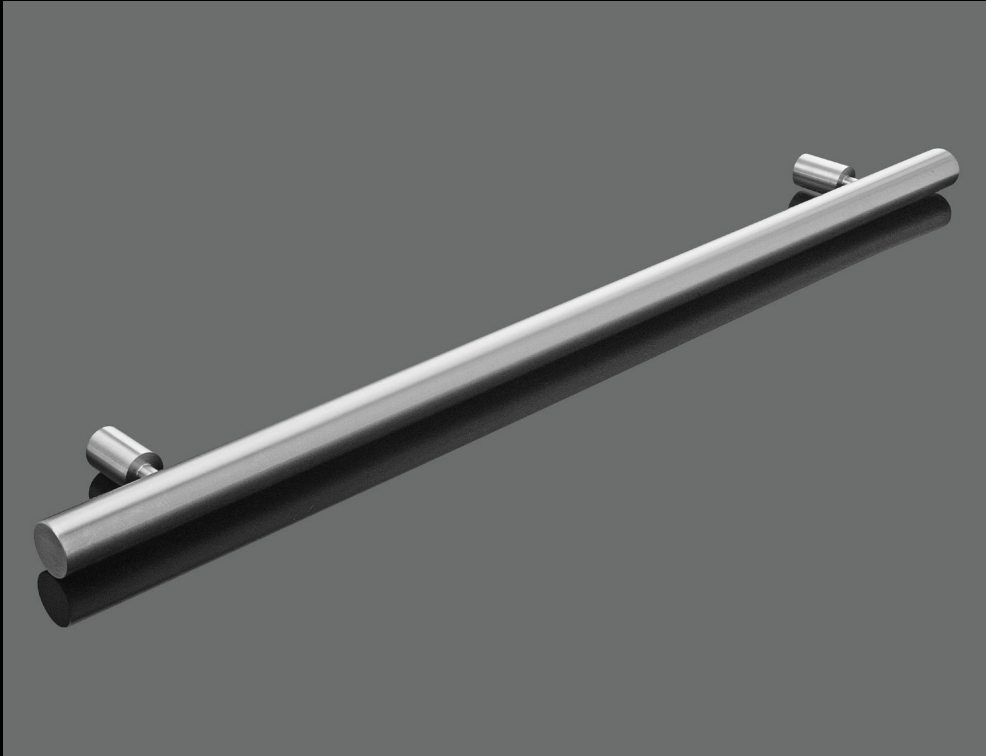

Dørhanke Ø38mm



Beskrivelse

- Gevind M12 500-700mm
- Gevind M12 701-900mm
- Gevind M12 901-1100mm
- Gevind M12 1101-1300mm
- Gevind M12 1301-1500mm
- Gevind M12 1501-1600mm
- Gevind M12 1601-1700mm
- Gevind M12 1701-1800mm
- Gevind M12 1801-1900mm
- Gevind M12 1901-2000mm
- Gevind M12 2001-2100mm
- Gevind M12 2101-2200mm
- Gevind M12 2201-2300mm
- Gevind M12 2301-2400mm
- Gevind M12 2401-2500mm
- Gevind M12 2501-2600mm
- Gevind M12 2601-2700mm
- Gevind M12 2701-2800mm
- Gevind M12 2801-2900mm
- Gevind M12 2901-3000mm

Varenummer

- 14.4812.02.010
- 14.4812.02.028
- 14.4812.02.036
- 14.4812.02.044
- 14.4812.02.052
- 14.4812.02.061
- 14.4812.02.079
- 14.4812.02.087
- 14.4812.02.095
- 14.4812.02.109
- 14.4812.02.117
- 14.4812.02.125
- 14.4812.02.133
- 14.4812.02.141
- 14.4812.02.150
- 14.4812.02.168
- 14.4812.02.170
- 14.4812.02.180
- 14.4812.02.190
- 14.4812.02.200

- Bøsning 500-700mm
- Bøsning 701-900mm
- Bøsning 901-1100mm
- Bøsning 1101-1300mm
- Bøsning 1301-1500mm
- Bøsning 1501-1600mm
- Bøsning 1601-1700mm
- Bøsning 1701-1800mm
- Bøsning 1801-1900mm
- Bøsning 1901-2000mm
- Bøsning 2001-2100mm
- Bøsning 2101-2200mm
- Bøsning 2201-2300mm
- Bøsning 2301-2400mm
- Bøsning 2401-2500mm
- Bøsning 2501-2600mm
- Bøsning 2601-2700mm
- Bøsning 2701-2800mm
- Bøsning 2801-2900mm
- Bøsning 2901-3000mm

- 14.4814.02.019
- 14.4814.02.027
- 14.4814.02.035
- 14.4814.02.043
- 14.4814.02.051
- 14.4814.02.060
- 14.4814.02.078
- 14.4814.02.086
- 14.4814.02.094
- 14.4814.02.108
- 14.4814.02.116
- 14.4814.02.124
- 14.4814.02.132
- 14.4814.02.141
- 14.4814.02.159
- 14.4814.02.167
- 14.4814.02.170
- 14.4814.02.180
- 14.4814.02.190
- 14.4814.02.200

Hanke med andre dimensioner end her angivet, kan muligvis leveres. Kontakt kundeservice for mere information

Cirkelhank



Cirkelhank

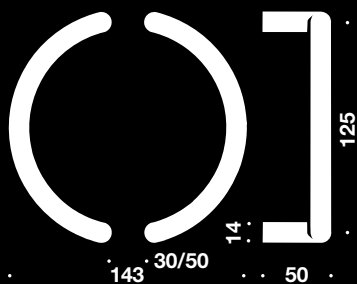

Beskrivelse
Gevind M8 125mm
Bøsning 125mm

Varenummer
14.4052.02.124
14.4054.02.123

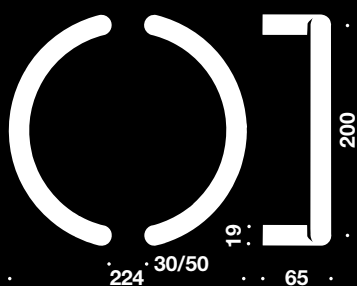

Gevind M8 200mm
Bøsning 200mm

14.4252.02.201
14.4254.02.201

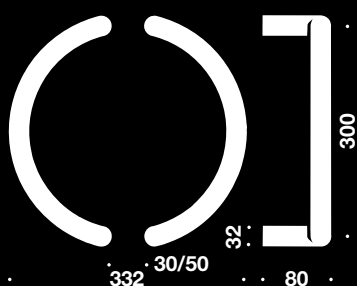

Gevind M12 300mm
Bøsning 300mm

14.4652.02.301
14.4654.02.301

Dørhanke på skilt Ø14mm

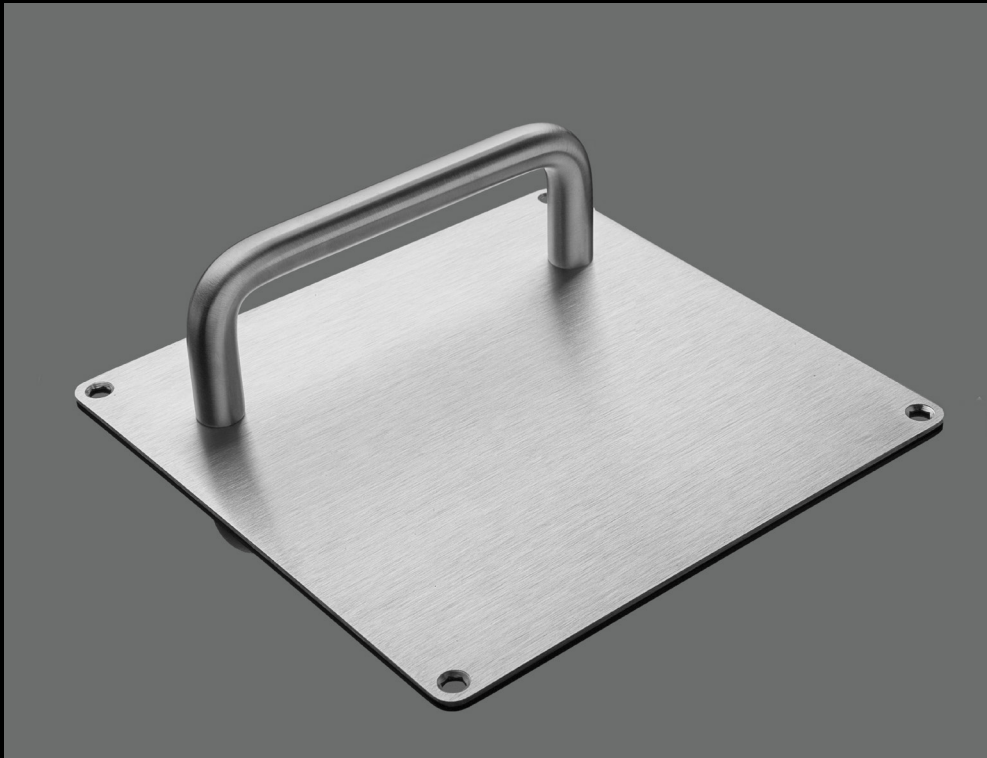

Dørhanke på skilt Ø14mm

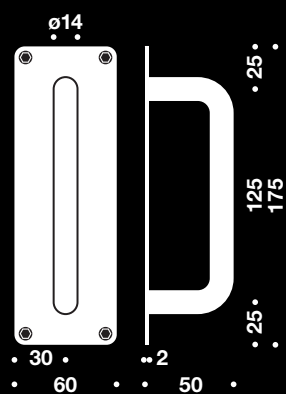

Beskrivelse
Lige, 60x175x2mm

Varenummer
14.4011.02.125

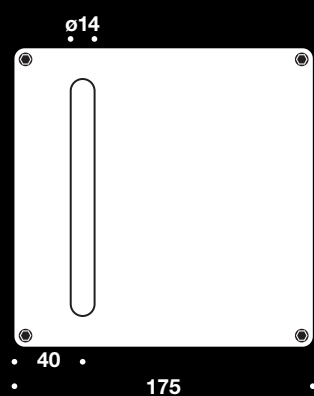

Lige, 175x175x2mm

14.4013.02.124



Dørhanke på skilt Ø19mm

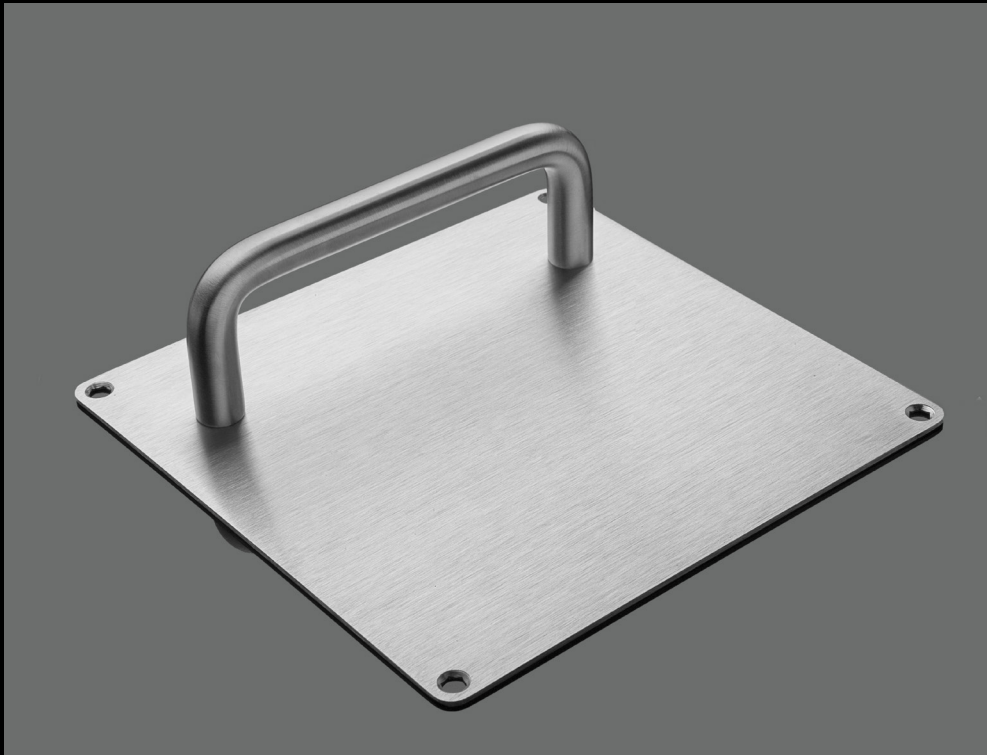

Dørhanke på skilt Ø19mm

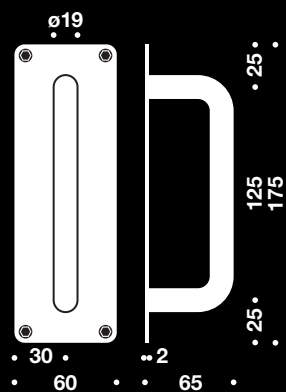

Beskrivelse
Lige, 60x175x2mm

Varenummer
14.4211.02.121

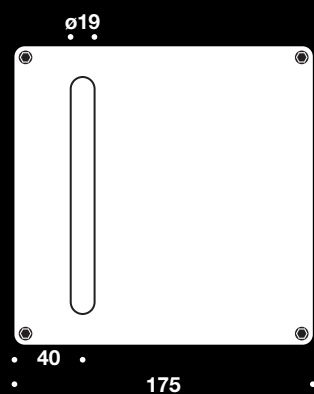

Lige, 175x175x2mm

14.4213.02.121



Albuehanke Ø16mm



Albuehanke Ø16 mm

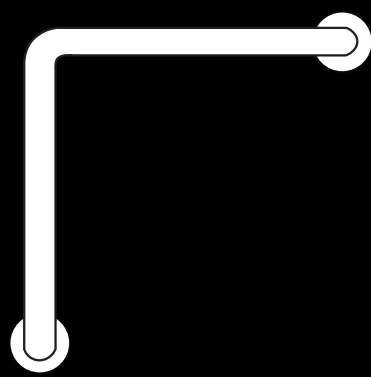

Beskrivelse

Sæt m/rosetter f/dørtykkelse >45mm, inkl. monteringssæt

Varenummer

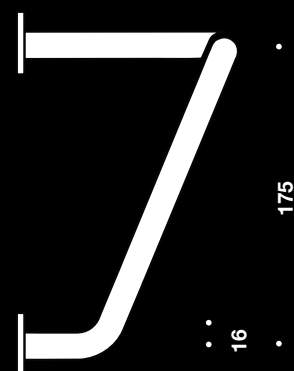
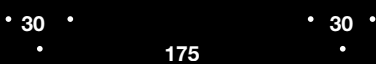

14.4070.02.106



Tilbehør til dørhanke, Ø14 & Ø19mm

Til glassdøre med forboret hul Ø12mm		Længde	Antal	Varenummer		
Maskineskrue		Skrue 30	2	14.4902.02.308		
		40	2	14.4902.02.405		
		50	2	14.4902.02.502		
		60	2	14.4902.02.600		
		Roset, Ø50	2	14.4960.02.084		
		Længde	Antal	Varenummer		
Maskineskrue		Skrue 30	2	14.4902.02.308		
		40	2	14.4902.02.405		
		50	2	14.4902.02.502		
		60	2	14.4902.02.600		
				Længde	Antal	Varenummer
Grisetrynebolt		Bolt 30	2	14.4920.02.306		
		60	2	14.4920.02.608		
		90	2	14.4920.02.900		
		Træ Roset, Ø30	2	14.4960.02.084		
		Glas Glasmontage f/roset	2 1	14.4965.00.106 14.4965.00.408		
		Længde	Antal	Varenummer		
Grisetrynebolt		Bolt 30	2	14.4920.02.306		
		60	2	14.4920.02.608		
		90	2	14.4920.02.900		
		Glas Glasmontage, Ø14	1	14.4965.00.106		
		Glas Glasmontage, Ø19	1	14.4965.00.301		
		Længde	Antal	Varenummer		
Undersænket skrue		Skrue 30	2	14.4955.92.309		
		55	2	14.4955.92.554		
		Bøsning Roset, Ø30	2 2	14.4950.00.002 14.4960.02.084		
				Længde	Antal	Varenummer
		Undersænket skrue		Skrue 60	2	14.4955.92.309
80	2			14.4955.92.554		
Bøsning	2			14.4950.00.002		
		Længde	Antal	Varenummer		
Dobbeltmontage		Bolt 30	2	14.4915.92.380		
		58	2	14.4915.92.584		
		98	2	14.4915.92.983		
		120	2	14.4915.92.991		
		Træ Roset, Ø30	4	14.4960.02.084		
		Glas Roset, Ø30	4 1	14.4965.00.106 14.4965.00.408		
				Længde	Antal	Varenummer
		Dobbeltmontage		Bolt 30	2	14.4915.92.380
				58	2	14.4915.92.584
				98	2	14.4915.92.983
120	2			14.4915.92.991		
Glas Ø14	1			14.4965.00.106		
Glas Ø19	1	14.4965.00.301				

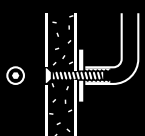
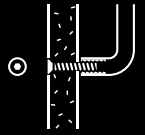
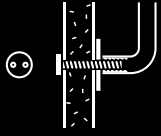
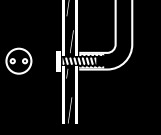
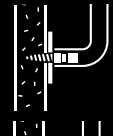
Tilbehør til dørhanke, Ø25mm

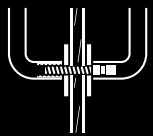
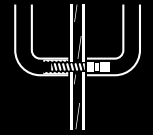
Til glasdøre med forboret hul Ø14mm		Længde	Antal	Varenummer			
Maskineskrue		Skrue	50	2	14.4903.02.507		
			60	2	14.4903.02.604		
			Roset, Ø50	2	14.4961.02.101		
			Længde	Antal	Varenummer		
		Skrue	50	2	14.4903.02.507		
			60	2	14.4903.02.604		
Grisetrynebolt		Bolt	30	2	14.4922.02.305		
			60	2	14.4922.02.607		
			100	2	14.4922.02.909		
			Roset, Ø50	2	14.4961.02.101		
		Glas		2	14.4965.00.459		
			Længde	Antal	Varenummer		
		Bolt	30	2	14.4922.02.305		
			60	2	14.4922.02.607		
			100	2	14.4922.02.909		
		Glas		1	14.4965.00.351		
Undersænket Skruer		Skrue	60	2	14.4910.91.603		
			80	2	14.4910.91.808		
		Bøsning		2	14.4952.92.003		
		Roset		2	14.4961.02.101		
			Længde	Antal	Varenummer		
		Skrue	60	2	14.4910.91.603		
			80	2	14.4910.91.808		
		Bøsning		2	14.4952.92.003		
		Dobbeltmontage		Bolt	30	2	14.4917.92.303
					60	2	14.4917.92.605
	100			2	14.4917.92.109		
	Roset, Ø50			4	14.4961.02.101		
Glas				1	14.4965.00.459		
		Længde	Antal	Varenummer			
	Bolt	30	2	14.4917.92.303			
		60	2	14.4917.92.605			
		100	2	14.4917.92.109			
	Glas	Ø25	1	14.4965.00.106			



Tilbehør til dørhanke, Ø32 & Ø38mm

Til glasdøre med forboret hul Ø16mm		Længde	Antal	Varenummer	
Maskineskrue		Skrue 50	2	14.4904.02.501	
		60	2	14.4904.02.609	
	Roset, Ø50	2	14.4961.02.127		
			Længde	Antal	Varenummer
Maskineskrue		Skrue 50	2	14.4904.02.501	
		60	2	14.4904.02.609	
			Længde	Antal	Varenummer
	Grisetrynebolt		Bolt 30	2	14.4921.02.301
60			2	14.4921.02.602	
100			2	14.4921.02.106	
Roset, Ø50			2	14.4961.02.127	
Glas		2	14.4965.00.700		
		Længde	Antal	Varenummer	
Grisetrynebolt		Bolt 30	2	14.4921.02.301	
		60	2	14.4921.02.602	
		100	2	14.4921.02.106	
	Glas	1	14.4965.00.505		
		Længde	Antal	Varenummer	
Undersænket Skrue		Skrue 60	2	14.4911.91.601	
		80	2	14.4911.91.806	
		Bøsning	2	14.4954.92.002	
	Roset	2	14.4961.02.127		
			Længde	Antal	Varenummer
Undersænket Skrue		Skrue 60	2	14.4911.91.601	
		80	2	14.4911.91.806	
		Bøsning	2	14.4954.92.002	
		Længde	Antal	Varenummer	
Dobbeltmontage		Bolt 30	2	14.4916.92.309	
		60	2	14.4916.92.601	
		100	2	14.4916.92.104	
		Roset, Ø50	4	14.4961.02.127	
	Glas	1	14.4965.00.700		
			Længde	Antal	Varenummer
Dobbeltmontage		Bolt 30	2	14.4916.92.309	
		60	2	14.4916.92.601	
		100	2	14.4916.92.104	
	Glas Ø32	1	14.4965.00.505		

Tilbehør til hanke

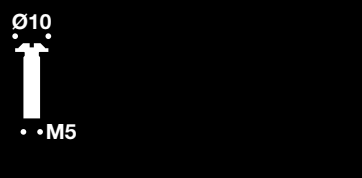
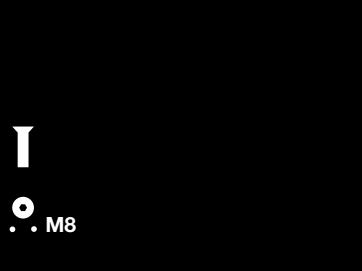
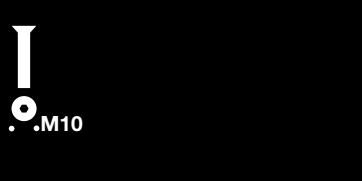
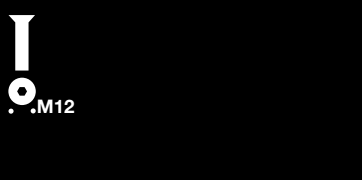

Tilbehør til hanke

	Beskrivelse	Varenummer
 <p>Ø10 M5</p>	M5x20mm t/Ø10mm møbelhank	14.4900.92.201
	M5x25mm t/Ø10mm møbelhank	14.4900.92.251
	M5x30mm t/Ø10mm møbelhank	14.4900.92.308
	M5x35mm t/Ø10mm møbelhank	14.4900.92.359
 <p>M8</p>	M8x30mm t/Ø14-19mm hank	14.4902.02.308
	M8x40mm t/Ø14-19mm hank	14.4902.02.405
	M8x50mm t/Ø14-19mm hank	14.4902.02.502
	M8x60mm t/Ø14-19mm hank	14.4902.02.600
 <p>M10</p>	M10x50mm t/Ø20-25mm hank	14.4903.02.507
	M10x60mm t/Ø20-25mm hank	14.4903.02.604
 <p>M12</p>	M12x50mm t/Ø30-38mm hank	14.4904.02.501
	M12x60mm t/Ø30-38mm hank	14.4904.02.609
 <p>M8/10</p>	M8x60mm t/Ø20-25mm hank	14.4910.92.603
	M8x80mm t/Ø20-25mm hank	14.4910.92.808
	M10x60mm t/Ø30-38mm hank	14.4911.91.601
	M10x80mm t/Ø30-38mm hank	14.4911.91.806

Tilbehør til hanke



Tilbehør til hanke



Beskrivelse

M8x30mm t/Ø14-19mm hank
 M8x60mm t/Ø14-19mm hank
 M8x90mm t/Ø14-19mm hank

Varenummer

14.4920.02.306
 14.4920.02.608
 14.4920.02.900



M10x30mm t/Ø20-25mm hank
 M10x60mm t/Ø20-25mm hank
 M10x90mm t/Ø20-25mm hank

14.4922.02.305
 14.4922.02.607
 14.4922.02.909



M12x30mm t/Ø32-38mm hank
 M12x60mm t/Ø30-38mm hank
 M12x100mm t/Ø30-38mm hank

14.4921.02.301
 14.4921.02.602
 14.4921.02.106



M8x30mm t/Ø14-19mm hank
 M8x58mm t/Ø14-19mm hank
 M8x98mm t/Ø14-19mm hank
 M8x120mm t/Ø14-19mm hank

14.4915.92.380
 14.4915.92.584
 14.4915.92.983
 14.4915.92.991

M10x30mm t/Ø20-25mm hank
 M10x60mm t/Ø20-25mm hank
 M10x100mm t/Ø20-25mm hank

14.4917.92.303
 14.4917.92.605
 14.4917.92.109

M12x30mm t/Ø32-38mm hank
 M12x60mm t/Ø32-38mm hank
 M12x100mm t/Ø32-38mm hank

14.4916.92.309
 14.4916.92.601
 14.4916.92.104





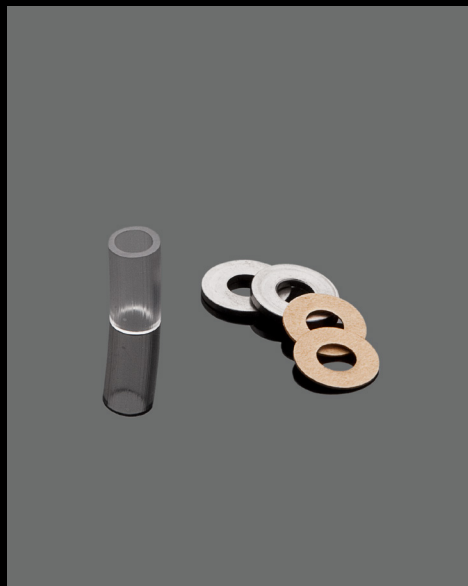

Træskrue 8x30 t/Ø14-19mm hank
 Træskrue 8x55 t/Ø14-19mm hank

14.4955.92.309
 14.4955.92.554

Tilbehør til hanke

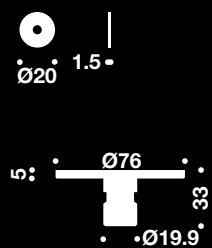

Tilbehør til hanke

 	Beskrivelse Messing, Ø10mm, 9x22x5,5mm t/Ø14-19mm hank	Varenummer 14.4950.00.002
  • 24 •	Galv., Ø14mm, 9x24x8mm t/Ø20-25mm hank Galv., Ø19mm, 9x22x10mm t/Ø30-38mm hank	14.4952.92.003 14.4954.92.002
	Ø20x5,2x1,5mm t/Ø10 mm hank Ø30x8,2x2mm t/Ø14-19 mm hank Ø50x8,2x3mm t/Ø20-25 mm hank Ø50x10,2x3mm t/Ø20-25 mm hank Ø50x12,2x3mm t/Ø30-38 mm hank Ø76x5mm t/Ø32 mm støttegreb	14.4962.02.067 14.4960.02.084 14.4961.02.089 14.4961.02.101 14.4961.02.127 14.4963.02.321
2 - • 20 •  • 1 •	T/Ø14mm hank T/Ø19mm hank T/Ø25mm hank T/Ø32/38mm hank T/Ø14/19mm hank, m/Ø30mm roset T/Ø25mm hank, m/Ø50mm roset T/Ø32/38mm hank, m/Ø50mm roset	14.4965.00.106 14.4965.00.301 14.4965.00.351 14.4965.00.505 14.4965.00.408 14.4965.00.459 14.4965.00.700

Vægdørstopper



Vægdørstoppere



Beskrivelse
Ø14x21mm

Varenummer
14.5050.02.009

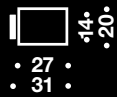

Ø20x31mm

14.5055.02.001



Ø14x70mm
Ø14x125mm

14.5060.02.002
14.5060.02.126



Ø14x70mm, m/stift
Ø14x125mm, m/stift

14.5065.02.005
14.5065.02.126

Løst gummi Ø14 t/dørstop 14.5050 + 14.5060 +14.5065
Løst gummi Ø20 t/dørstop 14.5055

14.9745.00.028
14.9745.00.061

Gulvdørstoppere



Gulvdørstoppere

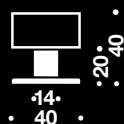

Beskrivelse
Ø40x40mm

Varenummer
14.5070.02.006

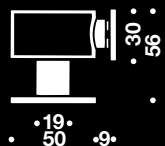

Ø50x56mm, m/magnet, holdkraft 8 kg
Ø50x56 mm, m/ekstra stærk magnet, holdkraft 16 kg

14.5075.02.009
14.5075.02.010

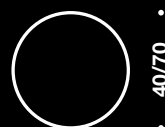

Ø70x30mm
Ø40x20mm

14.5080.02.000
14.9650.00.004



Skildpadde, Ø80x15mm
Skildpadde, Ø80x30mm

14.5080.02.015
14.5080.02.030

Løst gummi Ø40 t/dørstop 14.5070
Løst gummi m/magnet til dørstop 14.5075
Løst gummi t/dørstop 149650

14.9745.00.125
14.9745.00.141
14.9745.00.133

Vinduesgreb L form 14mm



Vinduesgreb L form 14mm

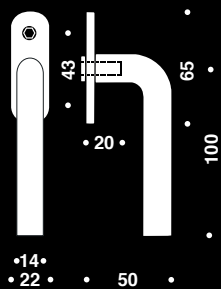

Beskrivelse

8x8mm stifthul, m/massiv oval roset 65x22mm, cc 43 mm

Varenummer

14.5400.02.000

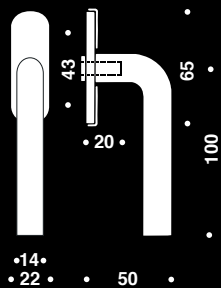

8x8mm stifthul, m/oval klipsroset 65x22mm, cc 43 mm

14.5401.02.800

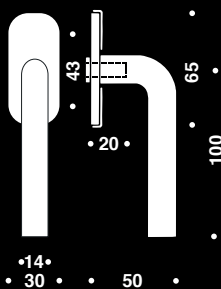

8x8mm stifthul, m/oval klipsroset 65x30mm, cc 43 mm

14.5401.02.801

Vinduesgreb U form 14mm



Vinduesgreb U form 14mm

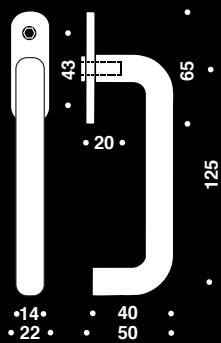

Beskrivelse

8x8mm stifthul, m/massiv oval roset 65x22mm, cc 43mm

Varenummer

14.5405.02.000

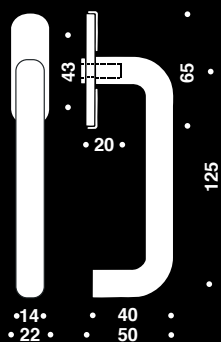

8x8mm stifthul, m/oval klipsroset 65x22mm, cc 43mm

14.5406.02.800

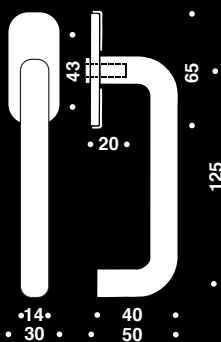

8x8mm stifthul, m/oval klipsroset 65x30mm, cc 43mm

14.5406.02.801

Vinduesgreb L form 16mm



Vinduesgreb L form 16mm

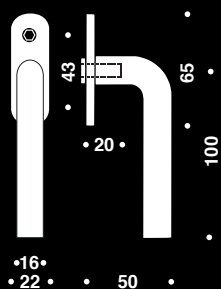

Beskrivelse

8x8mm stifthul, m/massiv oval roset 65x22mm, cc 43mm

Varenummer

14.5411.02.001

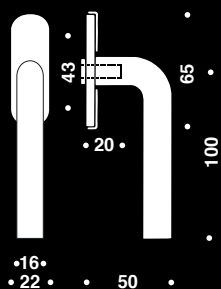

8x8mm stifthul, m/oval klipsroset 65x22mm, cc 43mm

14.5412.02.000

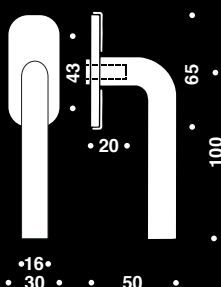

8x8mm stifthul, m/oval klipsroset 65x30mm, cc 43mm

14.5412.02.804

Vinduesgreb U form 16mm



Vinduesgreb U form 16mm

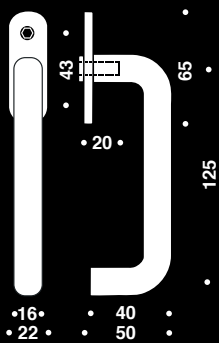

Beskrivelse

8x8mm stifthul, m/massiv oval roset 65x22mm, cc 43mm

Varenummer

14.5413.02.001

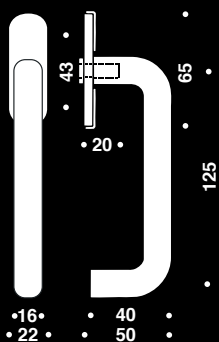

8x8mm stifthul, m/oval klipsroset 65x22mm, cc 43mm

14.5414.02.000

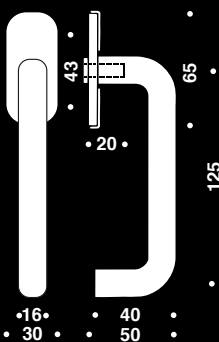

8x8mm stifthul, m/oval klipsroset 65x30mm, cc 43mm

14.5414.02.803

Vinduesgreb L form forkrøppet 16mm



Vinduesgreb L form forkrøppet 16mm

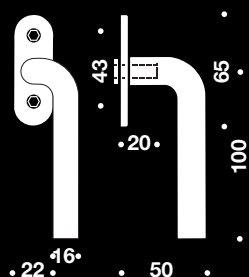

Beskrivelse

V, 8x8mm stiftthul, m/massiv oval roset 65x22mm, cc 43mm

H, 8x8mm stiftthul, m/massiv oval roset 65x22mm, cc 43mm

Varenummer

14.5416.02.039

14.5416.02.021

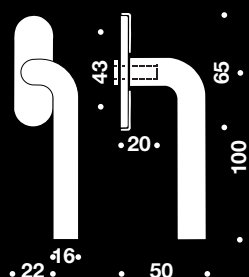

V, 8x8mm stiftthul, m/oval klipsroset 65x22mm, cc 43mm

H, 8x8mm stiftthul, m/oval klipsroset 65x22mm, cc 43mm

14.5418.02.050

14.5418.02.020

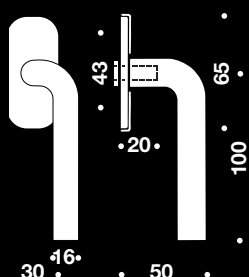

V, 8x8mm stiftthul, m/oval klipsroset 65x30mm, cc 43mm

H, 8x8mm stiftthul, m/oval klipsroset 65x30mm, cc 43mm

14.5418.02.822

14.5418.02.811

Vinduesgreb C form 16mm



Vinduesgreb C form 16mm

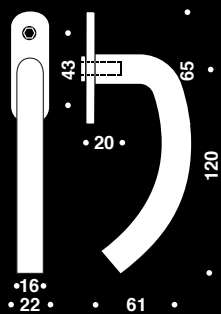

Beskrivelse

8x8mm stifthul, m/massiv oval roset 65x22mm, cc 43mm

Varenummer

14.5408.02.100

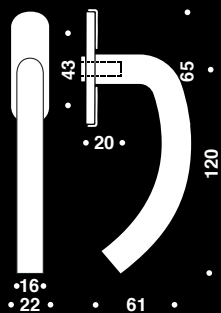

8x8mm stifthul, m/oval klipsroset 65x22mm, cc 43mm

14.5408.02.000

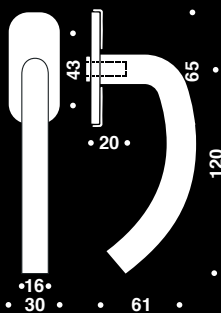

8x8mm stifthul, m/oval klipsroset 65x30mm, cc 43mm

14.5408.02.800

Vinduesgreb M form 16mm



Vinduesgreb M form 16mm

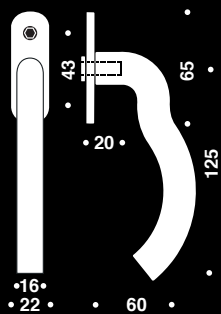

Beskrivelse

8x8mm stifthul, m/massiv oval roset 65x22mm, cc 43mm

Varenummer

14.5409.02.100

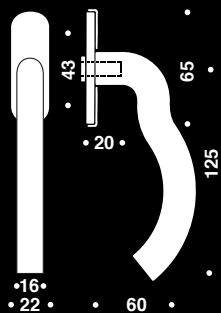

8x8mm stifthul, m/oval klipsroset 65x22mm, cc 43mm

14.5409.02.000

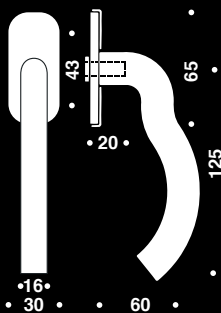

8x8mm stifthul, m/oval klipsroset 65x30mm, cc 43mm

14.5409.02.800

Vinduesgreb FF form 16mm



Vinduesgreb FF form 16mm

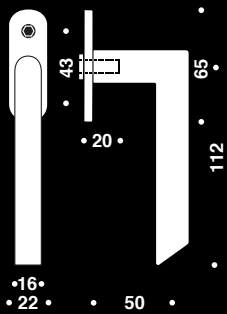

Beskrivelse

8x8mm stifthul, m/massiv oval roset 65x22mm, cc 43mm

Varenummer

14.5407.02.100

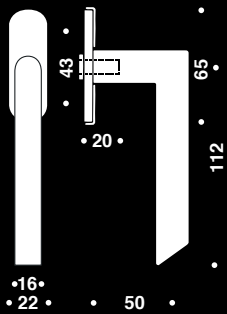

8x8mm stifthul, m/oval klipsroset 65x22mm, cc 43mm

14.5407.02.000

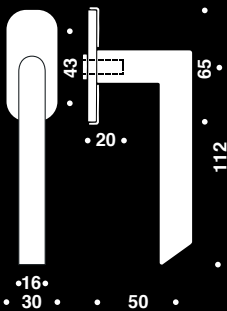

8x8mm stifthul, m/oval klipsroset 65x30mm, cc 43mm

14.5407.02.800

Vinduesgreb T form 16mm



Vinduesgreb T form 16mm

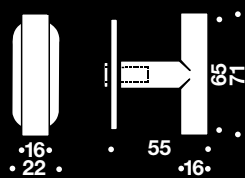

Beskrivelse

7x7mm stifthul, m/massiv oval roset 65x22mm, cc 43mm

Varenummer

14.5440.02.100

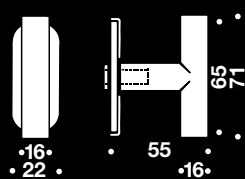

7x7mm stifthul, m/oval klipsroset 65x22mm, cc 43mm

14.5440.02.000

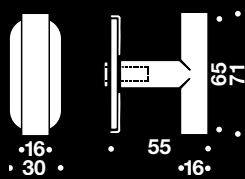

7x7mm stifthul, m/oval klipsroset 65x30mm, cc 43mm

14.5440.02.806

Vinduesgreb L form 16mm KLIKSTOP



Vinduesgreb L form 16mm KLIKSTOP

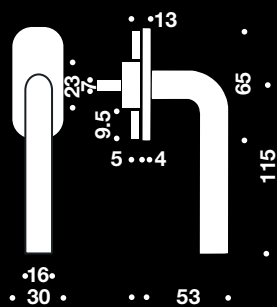

Beskrivelse

M/7x7mm stifthul, m/oval klipsroset 65x30mm, cc 43mm, 90°-180°

Varenummer

14.5420.02.027

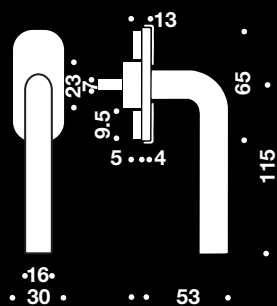

M/7x7mm stifthul, m/oval klipsroset 65x30mm, cc 43mm, 90°-135°-180°

14.5420.02.035

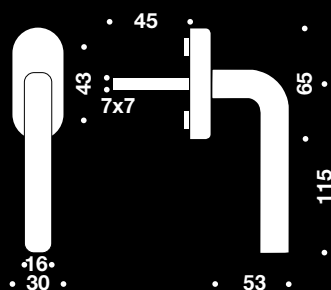

M/7x7mm stifthul, høj klipsroset 65x30mm, cc 43mm, 90°-180°

14.5420.02.040

Vinduesgreb U form 16mm KLIKSTOP



Vinduesgreb U form 16mm KLIKSTOP

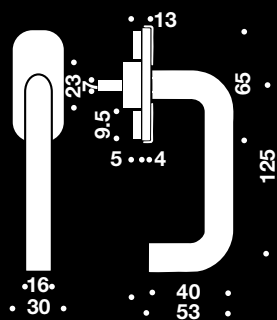

Beskrivelse

M/7x7mm stifthul, m/oval klipsroset 65x30mm, cc 43mm, 90°-180°

Varenummer

14.5425.02.020

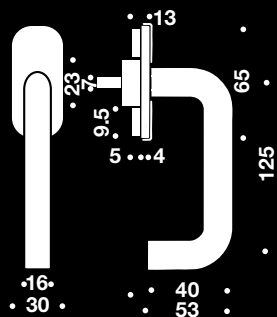

M/7x7mm stifthul, m/oval klipsroset 65x30mm, cc 43mm, 90°-135°-180°

14.5425.02.038

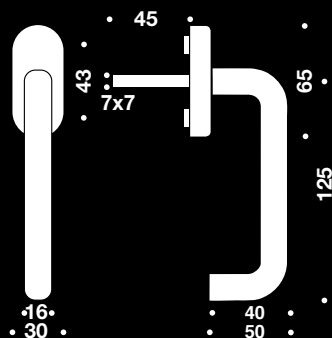

M/7x7mm stifthul, høj klipsroset 65x30mm, cc 43mm, 90°-180°

14.5425.02.040

Vinduesgreb M form 16mm KLIKSTOP



Vinduesgreb M form 16mm KLIKSTOP

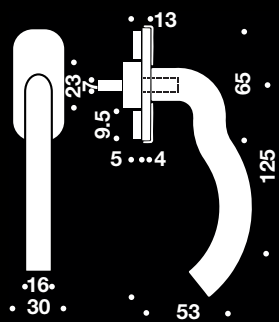

Beskrivelse

M/7x7mm stifthul, m/oval klipsroset 65x30mm, cc 43mm, 90°-180°

Varenummer

14.5422.02.020

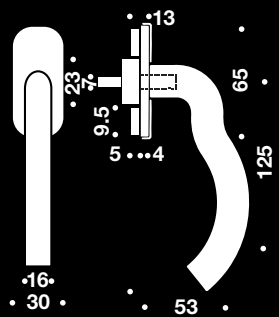

M/7x7mm stifthul, m/oval klipsroset 65x30mm, cc 43mm, 90°-135°-180°

14.5422.02.038

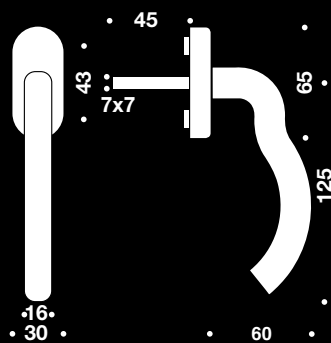

M/7x7mm stifthul, høj klipsroset 65x30mm, cc 43mm, 90°-180°

14.5422.02.040

Vinduesgreb C form 16mm KLIKSTOP



Vinduesgreb C form 16mm KLIKSTOP

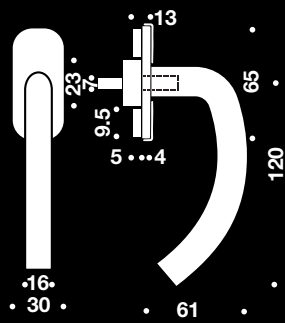

Beskrivelse

M/7x7mm stifthul, m/oval klipsroset 65x30mm, cc 43mm, 90°-180°

Varenummer

14.5421.02.020

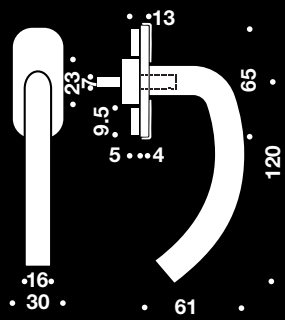

M/7x7mm stifthul, m/oval klipsroset 65x30mm, cc 43mm, 90°-135°-180°

14.5421.02.038

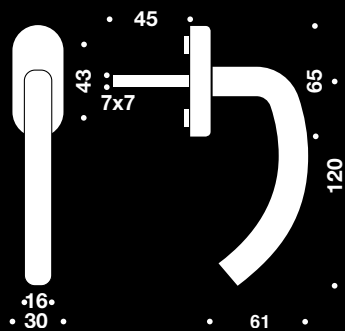

M/7x7mm stifthul, høj klipsroset 65x30mm, cc 43mm, 90°-180°

14.5421.02.040

Vinduesgreb FF form 16mm KLIKSTOP



Vinduesgreb FF form 16mm KLIKSTOP

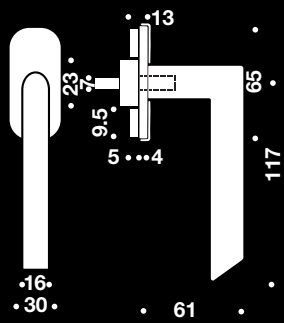

Beskrivelse

M/7x7mm stifthul, m/oval klipsroset 65x30mm, cc 43mm, 90°-180°

Varenummer

14.5423.02.020

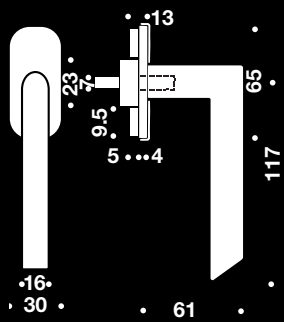

M/7x7mm stifthul, m/oval klipsroset 65x30mm, cc 43mm, 90°-135°-180°

14.5423.02.038

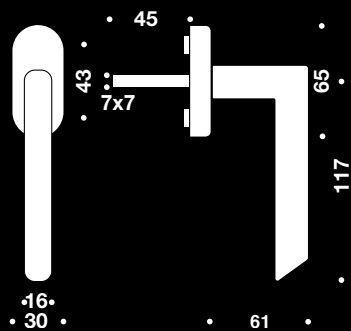

M/7x7mm stifthul, høj klipsroset 65x30mm, cc 43mm, 90°-180°

14.5423.02.040

Vinduesgreb FFG form 16mm KLIKSTOP



Vinduesgreb FFG form 16mm KLIKSTOP

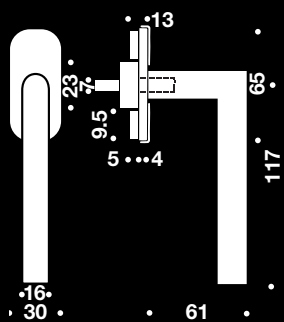

Beskrivelse

M/7x7mm stifthul, høj klipsroset 65x30mm, cc 43mm, 90°-180°

Varenummer

14.5424.02.040

Firkantstift og reduktionsbøsninger til vinduesgreb



Firkantstift og reduktionsbøsninger til vinduesgreb



Beskrivelse

7x7mm til 8x8mm
8x8mm til 9x9mm

Varenummer

14.5452.92.078
14.5452.92.089



7x7mm, 45mm
7x7mm, 50mm
7x7mm, 55mm
7x7mm, 65mm
7x7mm, 75mm

14.5454.92.459
14.5454.92.505
14.5454.92.556
14.5454.92.653
14.5454.92.751



8x8mm til 7x7mm, 45mm

14.5455.92.453

8x8mm, 40mm
8x8mm, 45mm
8x8mm, 50mm
8x8mm, 55mm
8x8mm, 65mm
8x8mm, 75mm
8x8mm, 85mm

14.5456.92.407
14.5456.92.458
14.5456.92.504
14.5456.92.555
14.5456.92.652
14.5456.92.750
14.5456.92.857

Gelænderholdere



Gelænderholdere

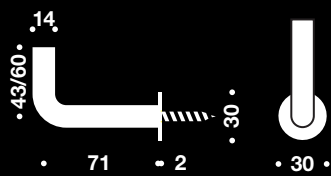

Beskrivelse

M8, 90°, 73x43mm

M8, 90°, 73x60mm

Varenummer

14.6000.02.008

14.6005.02.001

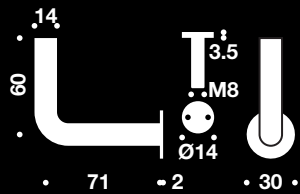

M8, 90°, m/glasmonteringsæt, 8-22mm glastykkelse

M8, 90°, m/glasmonteringsæt, 22-50mm glastykkelse

14.6005.02.005

14.6005.02.006

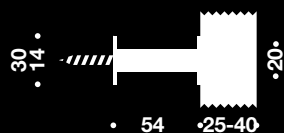

M8, lige 25-40mm, 54mm

14.6010.02.001

Kroge



Kroge

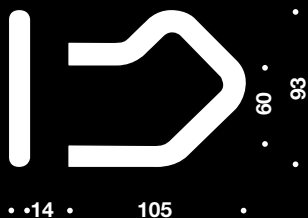

Beskrivelse
105x93mm

Varenummer
14.5615.02.006

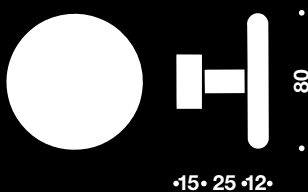

Ø80mm enkelt
Ø32x1000mm knagerække, m/5 knager

14.5625.02.000
14.5620.02.104



Dobbelkrog, Ø52mm, 5x55mm

14.6220.00.000